

STATE OF NORTH CAROLINA
DEPARTMENT OF TRANSPORTATION
HIGHWAY DIVISION 5

PROPOSAL

DATE AND TIME OF BID OPENING: JUNE 28TH, 2023 AT 2:00 PM

CONTRACT ID: DE00356

WBS ELEMENT NO.: 47148.3.1

FEDERAL AID NO.: 0507011

COUNTY: WAKE COUNTY

TIP NO.: U-6022

**TYPE OF WORK: CONSTRUCT ITS/SIGNAL SYSTEM IN FUQUAY-VARINA
TOWN WIDE**

NOTICE:

ALL BIDDERS SHALL COMPLY WITH ALL APPLICABLE LAWS REGULATING THE PRACTICE OF GENERAL CONTRACTING AS CONTAINED IN CHAPTER 87 OF THE GENERAL STATUTES OF NORTH CAROLINA WHICH REQUIRES THE BIDDER TO BE LICENSED BY THE N.C. LICENSING BOARD FOR CONTRACTORS WHEN BIDDING ON ANY NON-FEDERAL AID PROJECT WHERE THE BID IS \$30,000 OR MORE, EXCEPT FOR CERTAIN SPECIALTY WORK AS DETERMINED BY THE LICENSING BOARD. BIDDERS SHALL ALSO COMPLY WITH ALL OTHER APPLICABLE LAWS REGULATING THE PRACTICES OF ELECTRICAL, PLUMBING, HEATING AND AIR CONDITIONING AND REFRIGERATION CONTRACTING AS CONTAINED IN CHAPTER 87 OF THE GENERAL STATUTES OF NORTH CAROLINA. NOTWITHSTANDING THESE LIMITATIONS ON BIDDING, THE BIDDER WHO IS AWARDED ANY FEDERAL - AID FUNDED PROJECT SHALL COMPLY WITH CHAPTER 87 OF THE GENERAL STATUTES OF NORTH CAROLINA FOR LICENSING REQUIREMENTS WITHIN 60 CALENDAR DAYS OF BID OPENING.

THIS IS A ROADWAY PROJECT.

BID BONDS ARE REQUIRED.

NAME OF BIDDER

ADDRESS OF BIDDER

**PROPOSAL FOR THE CONSTRUCTION OF
CONTRACT No. DE00356 IN WAKE COUNTY, NORTH CAROLINA
DEPARTMENT OF TRANSPORTATION,
RALEIGH, NORTH CAROLINA**

The Bidder has carefully examined the location of the proposed work to be known as Contract No. **DE00356**; has carefully examined the plans and specifications, which are acknowledged to be part of the proposal, the special provisions, the proposal, the form of contract, and the forms of contract payment bond and contract performance bond; and thoroughly understands the stipulations, requirements and provisions. The undersigned bidder agrees to bound upon his execution of the bid and subsequent award to him by the Department of Transportation in accordance with this proposal to provide the necessary contract payment bond and contract performance bond within fourteen days after the written notice of award is received by him. The undersigned Bidder further agrees to provide all necessary machinery, tools, labor, and other means of construction; and to do all the work and to furnish all materials, except as otherwise noted, necessary to perform and complete the said contract in accordance with *the 2018 Standard Specifications for Roads and Structures* by the dates(s) specified in the Project Special Provisions and in accordance with the requirements of the Engineer, and at the unit or lump sum prices, as the case may be, for the various items given on the sheets contained herein.

The Bidder shall provide and furnish all the materials, machinery, implements, appliances and tools, and perform the work and required labor to construct and complete State Highway Contract No. **DE00356** in **Wake County**, for the unit or lump sum prices, as the case may be, bid by the Bidder in his bid and according to the proposal, plans, and specifications prepared by said Department, which proposal, plans, and specifications show the details covering this project, and hereby become a part of this contract.

The published volume entitled *North Carolina Department of Transportation, Raleigh, Standard Specifications for Roads and Structures, January 2018* with all amendments and supplements thereto, is by reference incorporated into and made a part of this contract; that, except as herein modified, all the construction and work included in this contract is to be done in accordance with the specifications contained in said volume, and amendments and supplements thereto, under the direction of the Engineer.

If the proposal is accepted and the award is made, the contract is valid only when signed either by the Contract Officer or such other person as may be designated by the Secretary to sign for the Department of Transportation. The conditions and provisions herein cannot be changed except over the signature of the said Contract Officer or Division Engineer.

The quantities shown in the itemized proposal for the project are considered to be approximate only and are given as the basis for comparison of bids. The Department of Transportation may increase or decrease the quantity of any item or portion of the work as may be deemed necessary or expedient.

An increase or decrease in the quantity of an item will not be regarded as sufficient ground for an increase or decrease in the unit prices, nor in the time allowed for the completion of the work, except as provided for the contract.

Accompanying this bid is a bid bond secured by a corporate surety, or certified check payable to the order of the Department of Transportation, for five percent of the total bid price, which deposit is to be forfeited as liquidated damages in case this bid is accepted and the Bidder shall fail to provide the required payment and performance bonds with the Department of Transportation, under the condition of this proposal, within 14 calendar days after the written notice of award is received by him, as provided in the Standard Specifications; otherwise said deposit will be returned to the Bidder.

TABLE OF CONTENTS

COVER SHEET
PROPOSAL SHEET

THIS CONTRACT IS FOR TIP U-6022 CONTRACT ID DE00356 FOR CONSTRUCT ITS/SIGNAL SYSTEM IN FUQUAY-VARINA TOWN WIDE TYPE OF WORK IN WAKE COUNTY.

INSTRUCTIONS TO BIDDERS5

PROJECT SPECIAL PROVISIONS - GENERAL

CONTRACTOR PREQUALIFICATION6

INTERESTED PARTIES LIST7

BOND REQUIREMENTS8

BUILD AMERICA, BUY AMERICA8

LIABILITY INSURANCE.....8

CONTRACT TIME & LIQUIDATED DAMAGES9

INTERMEDIATE CONTRACT TIME 1 & LIQUIDATED DAMAGES.....9

INTERMEDIATE CONTRACT TIME 2 & LIQUIDATED DAMAGES.....9

INTERMEDIATE CONTRACT TIME 3 & LIQUIDATED DAMAGES.....10

INTERMEDIATE CONTRACT TIME 4 & LIQUIDATED DAMAGES.....11

INTERMEDIATE CONTRACT TIME 5 & LIQUIDATED DAMAGES.....11

INTERMEDIATE CONTRACT TIME 6 & LIQUIDATED DAMAGES.....12

INTERMEDIATE CONTRACT TIME 7 & LIQUIDATED DAMAGES.....12

MAJOR CONTRACT ITEMS12

NO SPECIALITY ITEMS13

FUEL PRICE ADJUSTMENT13

SCHEDULE OF ESTIMATED COMPLETION PROGRESS.....14

DISADVANTAGE BUSINESS ENTERPRISE (DIVISIONS).....14

CERTIFICATION FOR FEDERAL-AID CONTRACTS28

CONTRACTOR’S LICENSE REQUIREMENTS.....29

RESTRICTIONS ON ITS EQUIPMENT & SERVICES.....29

USE OF UNMANNED AIRCRAFT SYSTEM (UAS)30

EQUIPMENT IDLING GUIDELINES30

US DEPARTMENT OF TRANSPORTATION HOTLINE30

ELECTRONIC BIDDING31

AWARD LIMITS31

REVISION TO FHWA-1273 FOR TAP FUNDED PROJECTS31

PROJECT SPECIAL PROVISIONS - ROADWAY

BURNING RESTRICTIONSRW-1

MATERIAL & EQUIPMENT STORAGE & PARKING OF
PERSONAL VEHICLESRW-1

LAW ENFORCEMENTRW-2

WORK ZONE INSTALLER.....RW-2

STANDARD SPECIAL PROVISIONS

AVAILABILITY OF FUNDS – TERMINATION OF CONTRACTSSSP-1
ERRATASSP-2
PLANT & PEST QUARANTINES.....SSP-10
TITLE VI & NONDISCRIMINATIONSSP-11
MINORITY & FEMALE EMPLOYMENT REQUIREMENTSSSP-18
REQUIRED CONTRACT PROVISION FEDERAL-AID
CONSTRUCTION CONTRACTSSSP-21
ON-THE-JOB TRAININGSSP-34
MINIMUM WAGESSSP-37

SIGNALS AND INTELLIGENT TRANSPORTATION SPECIAL PROVISIONS
PERMITS
BID BOND
BID FORM

INSTRUCTIONS TO BIDDERS

**PLEASE READ ALL INSTRUCTIONS CAREFULLY
BEFORE PREPARING AND SUBMITTING YOUR BID.**

All bids shall be prepared and submitted in accordance with the following requirements. Failure to comply with any requirement may cause the bid to be considered irregular and may be grounds for rejection of the bid.

For preparing and submitting the bid electronically, refer to Article 102-8(B) of the *2018 Standard Specifications*.

Bidders that bid electronically on Raleigh Central-Let projects will need a separate Digital Signature from the approved electronic bidding provider for Division Contracts.

ELECTRONIC ON-LINE BID:

1. Download entire proposal from Connect NCDOT website. Download the electronic submittal file from the approved electronic bidding provider website.
2. If the *Interested Parties List* provision SP01 G02 is part of the proposal prior to submitting a bid on a project, the bidder shall sign up on the *Interested Parties List* in conformance with Interested Parties List provision SP01 G02.
3. Prepare and submit the electronic submittal file using the approved electronic bidding provider software.
4. Electronic bidding software necessary for electronic bid preparation may be downloaded from the Connect NCDOT website at: <https://connect.ncdot.gov/letting/Pages/Electronic-Bidding.aspx> or from the approved electronic bidding provider website.

PROJECT SPECIAL PROVISIONS**GENERAL****CONTRACTOR PREQUALIFICATION:**

(10-18-22)(Rev. 7-18-23)

102

SP1 G01

Revise the *2018 Standard Specifications* as follows:

Page 1-9, Subarticle 102-2(A)(1) Bidder Prequalification, lines 34-36, delete and replace the first sentence with the following:

Applicant shall submit a completed Department Prequalification Application and *Bidder Experience Questionnaire*, along with any additional supporting information requested by the Department, as noted in the application and experience questionnaire package.

Page 1-10, Subarticle 102-2(A) Bidder Prequalification, lines 30-31, delete and replace the first sentence with the following:

Prospective bidders shall obtain prequalification approval at least two business days prior to any letting in which they intend to submit a bid. It is recommended that the prospective bidder file all required statements and documents with the State Prequalifications Engineer no less than 4 weeks before a given letting.

Page 1-10, Subarticle 102-2(B) Purchase Order Bidder Prequalification, lines 34-39, delete and replace the title and first paragraph with the following:

(B) Purchase Order (PO) Prime Contractor Prequalification

Contractors who have been approved to be placed on the Prequalified Bidders' List as noted above may perform work for the Department as a Purchase Order (PO) Prime Contractor and need not apply further. However, Purchase Order (PO) Prime Contractors will not be placed on the Prequalified Bidders' List unless they submit through the prequalification process described above.

Page 1-9, Subarticle 102-2(B)(1) Purchase Order Bidder Prequalification, lines 40-42, delete and replace the first sentence with the following:

Applicant shall submit a completed Department Prequalification Application along with any additional supporting information requested by the Department, as noted in the application.

Page 1-11, Subarticle 102-2(B) Purchase Order Bidder Prequalification, lines 16-18, delete and replace the first sentence with the following:

Prospective bidders shall obtain prequalification approval at least two business days prior to any letting in which they intend to submit a bid. It is recommended that the applicant file all required statements and documents with the State Prequalifications Engineer no less than 4 weeks before a given bid opening for their bid to be considered.

Page 1-11, Subarticle 102-2(C) Subcontractor Prequalification, lines 22-26, delete and replace the first paragraph with the following:

Contractors who have been approved to be placed on the Prequalified Bidders' List or the Purchase Order (PO) Prime Contractor's List as noted above may perform work for the Department as a subcontractor and need not apply further. However, subcontractors will not be placed on the Prequalified List or the Purchase Order (PO) Prime Contractor's List unless they submit through the prequalification process described above.

Page 1-11, Subarticle 102-2(C)(1) Subcontractor Prequalification, lines 27-28, delete and replace the first sentence with the following:

Applicant shall submit a completed Department Prequalification Application along with any additional supporting information requested by the Department, as noted in the application.

Page 1-11, Subarticle 102-2(C) Subcontractor Prequalification, lines 44-45, delete and replace the first sentence with the following:

The subcontractor shall file all required statements and documents with the State Prequalifications Engineer no less than 4 weeks before beginning work.

Page 1-12, Subarticle 102-2(E) Renewal and Requalification, lines 38-40, delete and replace the first sentence with the following:

It is recommended that the renewing or requalifying firm file all required statements and documents with the State Prequalifications Engineer no less than 4 weeks before a given letting for their bid to be considered.

INTERESTED PARTIES LIST:

(6-21-22)(Rev. 7-19-22)

102

SP1 G02

Revise the *2018 Standard Specifications* as follows:

Page 1-12, Article 102-3 PROPOSALS AND PLAN HOLDER LISTS, lines 45-49, delete and replace with the following:

102-3 PROPOSALS AND INTERESTED PARTIES LIST

On Department projects advertised, the prospective bidder shall sign up on the *Interested Parties List* no later than one business day prior to the Letting day of that project, for which he intends to submit a bid. There is no cost for signing up on the *Interested Parties List* that can be found on the Department's website at connect.ncdot.gov/letting.

Page 1-12, Article 102-3 PROPOSALS AND PLAN HOLDER LISTS, lines 1-3, delete and replace the first sentence of the second paragraph with the following:

The proposal will state the location of the contemplated construction and show a schedule of contract items with the approximate quantity of each of these items for which bid prices are invited.

Page 1-14, Article 102-8 PREPARATION AND SUBMISSION OF BIDS, lines 30-31, delete and replace the first paragraph with the following:

Prior to submitting a bid on a project, the bidder shall sign up on the *Interested Parties List* in conformance

with Article 102-3. The bidder shall submit a unit or lump sum price for every item in the proposal other than items that are authorized alternates to those items for which a bid price has been submitted.

BOND REQUIREMENTS:

(06-01-16)

102-8, 102-10

SPD 01-420A

A Bid Bond is required in accordance with Article 102-10 of the *2018 Standard Specifications for Roads and Structures*.

Contract Payment and Performance Bonds are required in accordance with Article 103-7 of the *2018 Standard Specifications for Roads and Structures*.

BUILD AMERICA, BUY AMERICA (BABA):

(11-15-22)

106

SP1 G04

Revise the *2018 Standard Specifications* as follows:

Page 1-53, Article 106-1 GENERAL REQUIREMENTS, add the following after line 27:

(C) Build America, Buy America (BABA)

All manufactured products and construction materials permanently incorporated into any project must meet requirements of the Build America, Buy America (BABA) Act of the Infrastructure Investment and Jobs Act (IIJA). Before any material or product shown on the Department's Build America, Buy America (BABA) List is included for payment on a monthly estimate, the Contractor shall furnish the Engineer with a notarized certification certifying that the items conform to the BABA Act. The Department's Build America Buy America (BABA) List can be found on the Department's website.

<https://connect.ncdot.gov/letting/LetCentral/NCDOT%20BABA%20Materials%20List.pdf>

Each purchase order issued by the Contractor or a subcontractor for items on the BABA List to be permanently incorporated into any project shall contain in bold print a statement advising the supplier that the manufactured products and construction materials must be produced in the United States of America. The Contractor and all affected subcontractors shall maintain a separate file for BABA List items so that verification of the Contractor's efforts to purchase items produced in the United States can readily be verified by an authorized representative of the Department or the Federal Highway Administration (FHWA).

LIABILITY INSURANCE:

(5-16-23)

107

SP1 G05

Revise the *2018 Standard Specifications* as follows:

Page 1-64, Article 107-15 LIABILITY INSURANCE, replace the first sentence with the following:

The Contractor shall at its sole cost and expense obtain and furnish to the Department an original standard Association for Cooperative Operations Research and Development (ACORD) certificate of liability insurance evidencing commercial general liability with a limit for bodily injury and property damage in the amount of \$5,000,000 per occurrence and \$5,000,000 general aggregate, covering the Contractor from claims or damages for bodily injury, personal injury, or for property damages that may arise from operating under the contract by the employees and agents of the Contractor.

CONTRACT TIME AND LIQUIDATED DAMAGES:

(7-1-95) (Rev. 12-18-07)

108

SP1 G10 A

The date of availability for this contract is **AUGUST 11th, 2023**.

The completion date for this contract is **AUGUST 11TH, 2025**.

Except where otherwise provided by the contract, observation periods required by the contract will not be a part of the work to be completed by the completion date and/or intermediate contract times stated in the contract. The acceptable completion of the observation periods that extend beyond the final completion date shall be a part of the work covered by the performance and payment bonds.

The liquidated damages for this contract are **ONE THOUSAND ONE HUNDRED DOLLARS (\$ 1,100.00)** per calendar day.

INTERMEDIATE CONTRACT TIME NUMBER 1 AND LIQUIDATED DAMAGES:

(2-20-07)

108

SP1 G14 C

The Contractor shall complete the required work of installing, maintaining and removing the traffic control devices for lane closures and restoring traffic to the existing traffic pattern. The Contractor shall not close or narrow a lane of traffic on **US-401 and NC-540** during the following time restrictions:

DAY AND TIME RESTRICTIONS

7:00 AM thru 7:00 PM

The time of availability for this intermediate contract time will be the time the Contractor begins to install traffic control devices required for the lane closures according to the time restrictions stated herein.

The completion time for this intermediate contract time will be the time the Contractor is required to complete the removal of traffic control devices required for the lane closures according to the time restrictions stated herein and restore traffic to the existing traffic pattern.

The liquidated damages are **TWO HUNDRED FIFTY DOLLARS (\$ 250.00)** per fifteen minutes.

INTERMEDIATE CONTRACT TIME NUMBER 2 AND LIQUIDATED DAMAGES:

(2-20-07)

108

SP1 G14 C

The Contractor shall complete the required work of installing, maintaining and removing the traffic control devices for lane closures and restoring traffic to the existing traffic pattern. The Contractor shall not close or narrow a lane of traffic on **Sunset Lake Road at Old Honeycut Road, NC-55 at Wake Chapel road, and US-401 at Ideal Lane** during the following time restrictions:

DAY AND TIME RESTRICTIONS

7:00 AM thru 9:00 AM
3:00 PM thru 7:00 PM

The Contractor shall complete the required work of installing, maintaining and removing the traffic control devices for lane closures and restoring traffic to the existing traffic pattern. The Contractor shall not close or narrow a lane of traffic on **ALL OTHER ROUTES** during the following time restrictions:

DAY AND TIME RESTRICTIONS

7:00 AM thru 9:00 AM
4:00 PM thru 7:00 PM

The time of availability for this intermediate contract time will be the time the Contractor begins to install traffic control devices required for the lane closures according to the time restrictions stated herein.

The completion time for this intermediate contract time will be the time the Contractor is required to complete the removal of traffic control devices required for the lane closures according to the time restrictions stated herein and restore traffic to the existing traffic pattern.

The liquidated damages are **TWO HUNDRED FIFTY DOLLARS (\$ 250.00)** per fifteen minutes.

INTERMEDIATE CONTRACT TIME NUMBER 3 AND LIQUIDATED DAMAGES:

(2-20-07)

108

SP1 G14 B

The Contractor shall not narrow or close a lane of traffic on all routes, detain and /or alter the traffic flow on or during holiday weekends, special events, or any other time when traffic is unusually heavy, including the following schedules:

HOLIDAY AND HOLIDAY WEEKEND LANE CLOSURE RESTRICTIONS

1. For **unexpected occurrence** that creates unusually high traffic volumes, as directed by the Engineer.
2. For **New Year's Day**, between the hours of 6:00 AM December 31st and 7:00 PM January 2nd. If **New Year's Day** is on a Friday, Saturday, Sunday or Monday, then until [hour] the following Tuesday.
3. For **Easter**, between the hours of 6:00 AM Thursday and 7:00 PM Monday.
4. For **Memorial Day**, between the hours of 6:00 AM Friday and 7:00 PM Tuesday.
5. For **Independence Day**, between the hours of 6:00 AM the day before **Independence Day** and 7:00 PM the day after **Independence Day**.

If **Independence Day** is on a Friday, Saturday, Sunday or Monday, then between the hours of 6:00 AM the Thursday before **Independence Day** and 7:00 PM the Tuesday after **Independence Day**.

6. For **Labor Day**, between the hours of 6:00 AM Friday and 7:00 PM Tuesday.
7. For **Thanksgiving Day**, between the hours of 6:00 AM Tuesday and 7:00 PM Monday.
8. For **Christmas**, between the hours of 6:00 AM the Friday before the week of Christmas Day and 7:00 PM the following Tuesday after the week of Christmas Day.

Holidays and holiday weekends shall include New Year's, Easter, Memorial Day, Independence Day, Labor Day, Thanksgiving, and Christmas. The Contractor shall schedule his work so that lane closures are not required during these periods, unless otherwise directed by the Engineer.

The time of availability for this intermediate contract work shall be the time the Contractor begins to install all traffic control devices for lane closures according to the time restrictions listed herein.

The completion time for this intermediate contract work shall be the time the Contractor is required to complete the removal of all traffic control devices for lane closures according to the time restrictions stated herein and place traffic in the existing traffic pattern.

The liquidated damages are **TWO HUNDRED FIFTY DOLLARS (\$ 250.00)** per hour.

INTERMEDIATE CONTRACT TIME NUMBER 4 AND LIQUIDATED DAMAGES:

(5-21-13)

108

SP1 G14 I

The Contractor shall complete the work required of installing each new inductive loop after the removal of each existing loop by the milling, patching or resurfacing operations and shall place and maintain traffic on same.

The date of availability for this intermediate contract time for each inductive loop installation will be the date when the Contractor elects to disturb the existing inductive loop.

The completion date for this intermediate contract time for each inductive loop installation will be the date which is seven (7) consecutive calendar days after the date of availability.

The liquidated damages are **FIVE HUNDRED DOLLARS (\$ 500.00)** per calendar day.

INTERMEDIATE CONTRACT TIME NUMBER 5 AND LIQUIDATED DAMAGES:

The Contractor shall field visit each new and existing intersection no less than one (1) time a week to maintain existing signal coordination and common controller clock time until final acceptance of the project. All clocks that are updated shall be updated from a single clock source.

Liquidated Damages for failure to visit each intersection at least one (1) time a week to check and update clocks will result in a liquidated damage of **FIVE HUNDRED DOLLARS (\$ 500.00)** per visit not performed.

INTERMEDIATE CONTRACT TIME NUMBER 6 AND LIQUIDATED DAMAGES:

The Contractor shall complete all work for a given group and verify it is fully functional before starting work in a different group. After taking down an existing communication channel, the contractor must complete all construction for traffic signals in that channel in a time period no greater than two (2) days per traffic signal in that channel. Establish time-based coordination within the limits of the prior closed loop system and maintain controller clocks.

Liquidated Damages to complete all work for a given group and verify it is fully functional before starting work in a different group in a time period no greater than two (2) days per traffic signal in a groups channel will result in liquidated damage of **FIVE HUNDRED DOLLARS (\$ 500.00)** per day.

INTERMEDIATE CONTRACT TIME NUMBER 7 AND LIQUIDATED DAMAGES:

The Contractor shall complete all repairs to all sidewalks removed for construction with in-kind materials and reopen the repaired and restored sidewalk to pedestrian traffic within five consecutive calendar days following initial removal. If the Contractor fails to repair and reopen a sidewalk in accordance with these Project Special provisions within the time frame specified, the Department reserves the right to make the necessary repairs, and all expenses incurred by the Department in making the repairs and restoring the sidewalk will be deducted from payment due the Contractor, plus \$500 liquidated damage per occasion, per day, or any portion thereof, until corrected.

Liquidated Damages for failure to complete all repairs with in-kind materials to all sidewalks removed for construction and reopening the repaired and restored sidewalk to pedestrian traffic within five consecutive calendar days following initial removal will result in a liquidated damage of **FIVE HUNDRED DOLLARS (\$ 500.00)** per occasion, per day, or any portion thereof, until corrected.

MAJOR CONTRACT ITEMS:

(2-19-02)

104

SP1 G28

The following listed items are the major contract items for this contract (see Article 104-5 of the *2018 Standard Specifications*):

Line #	Description
19 —	DIRECTIONAL DRILL (2)(2")
32 —	COMMUNICATION CABLE (24 FIBER)
46 —	CONTROLLERS WITH CABINET (2070X, BASE MTD)

NO SPECIALTY ITEMS:

(7-1-95)

108-6

SP1 G34

None of the items included in this contract will be specialty items (see Article 108-6 of the *2018 Standard Specifications*).

FUEL PRICE ADJUSTMENT:

(11-15-05) (Rev. 11-15-22)

109-8

SP1 G43

Revise the *2018 Standard Specifications* as follows:

Page 1-87, Article 109-8, Fuel Price Adjustments, add the following:

The base index price for DIESEL #2 FUEL is \$ **2.4999** per gallon. Where any of the following are included as pay items in the contract, they will be eligible for fuel price adjustment.

The pay items and the fuel factor used in calculating adjustments to be made will be as follows:

Description	Units	Fuel Usage Factor Diesel
Unclassified Excavation	Gal/CY	0.29
Borrow Excavation	Gal/CY	0.29
Class IV Subgrade Stabilization	Gal/Ton	0.55
Aggregate Base Course	Gal/Ton	0.55
Sub-Ballast	Gal/Ton	0.55
Erosion Control Stone	Gal/Ton	0.55
Rip Rap, Class _____	Gal/Ton	0.55
Asphalt Concrete Base Course, Type _____	Gal/Ton	0.90 or 2.90
Asphalt Concrete Intermediate Course, Type _____	Gal/Ton	0.90 or 2.90
Asphalt Concrete Surface Course, Type _____	Gal/Ton	0.90 or 2.90
Open-Graded Asphalt Friction Course	Gal/Ton	0.90 or 2.90
Permeable Asphalt Drainage Course, Type _____	Gal/Ton	0.90 or 2.90
Sand Asphalt Surface Course, Type _____	Gal/Ton	0.90 or 2.90
Ultra-thin Bonded Wearing Course	Gal/Ton	0.90 or 2.90
Aggregate for Cement Treated Base Course	Gal/Ton	0.55
Portland Cement for Cement Treated Base Course	Gal/Ton	0.55
> 11" Portland Cement Concrete Pavement	Gal/SY	0.327
Concrete Shoulders Adjacent to > 11" Pavement	Gal/SY	0.327
9" to 11" Portland Cement Concrete Pavement	Gal/SY	0.272
Concrete Shoulders Adjacent to 9" to 11" Pavement	Gal/SY	0.272
< 9" Portland Cement Concrete Pavement	Gal/SY	0.245
Concrete Shoulders Adjacent to < 9" Pavement	Gal/SY	0.245

For the asphalt items noted in the chart as eligible for fuel adjustments, the bidder may include the *Fuel Usage Factor Adjustment Form* with their bid submission if they elect to use the fuel usage factor. The *Fuel Usage Factor Adjustment Form* is found at the following link:

<https://connect.ncdot.gov/letting/LetCentral/Fuel%20Usage%20Factor%20Adjustment%20Form%20-%20%20Starting%20Nov%202022%20Lettings.pdf>

Select either 2.90 Gal/Ton fuel factor or 0.90 Gal/Ton fuel factor for each asphalt line item on the *Fuel Usage Factor Adjustment Form*. The selected fuel factor for each asphalt item will remain in effect for the duration of the contract.

Failure to complete the *Fuel Usage Factor Adjustment Form* will result in using 2.90 gallons per ton as the Fuel Usage Factor for Diesel for the asphalt items noted above. The contractor will not be permitted to change the Fuel Usage Factor after the bids are submitted.

SCHEDULE OF ESTIMATED COMPLETION PROGRESS:

(7-15-08) (Rev. 7-19-22)

108-2

SP1 G58

The Contractor's attention is directed to the Standard Special Provision entitled *Availability of Funds Termination of Contracts* included elsewhere in this proposal. The Department of Transportation's schedule of estimated completion progress for this project as required by that Standard Special Provision is as follows:

	<u>Fiscal Year</u>	<u>Progress (% of Dollar Value)</u>
2024	(7/01/23 - 6/30/24)	50% of Total Amount Bid
2025	(7/01/24 - 6/30/25)	50% of Total Amount Bid

The Contractor shall also furnish his own progress schedule in accordance with Article 108-2 of the *2018 Standard Specifications*. Any acceleration of the progress as shown by the Contractor's progress schedule over the progress as shown above shall be subject to the approval of the Engineer.

DISADVANTAGED BUSINESS ENTERPRISE (DIVISIONS):

(10-16-07)(Rev. 8-17-21)

102-15(J)

SP1 G62

Description

The purpose of this Special Provision is to carry out the U.S. Department of Transportation's policy of ensuring nondiscrimination in the award and administration of contracts financed in whole or in part with Federal funds. This provision is guided by 49 CFR Part 26.

Definitions

Additional DBE Subcontractors - Any DBE submitted at the time of bid that will not be used to meet the DBE goal. No submittal of a Letter of Intent is required.

Committed DBE Subcontractor - Any DBE submitted at the time of bid that is being used to meet the DBE goal by submission of a Letter of Intent. Or any DBE used as a replacement for a previously committed DBE firm.

Contract Goal Requirement - The approved DBE participation at time of award, but not greater than the advertised contract goal.

DBE Goal - A portion of the total contract, expressed as a percentage, that is to be performed by committed DBE subcontractor(s).

Disadvantaged Business Enterprise (DBE) - A firm certified as a Disadvantaged Business Enterprise through the North Carolina Unified Certification Program.

Goal Confirmation Letter - Written documentation from the Department to the bidder confirming the Contractor's approved, committed DBE participation along with a listing of the committed DBE firms.

Manufacturer - A firm that operates or maintains a factory or establishment that produces on the premises, the materials or supplies obtained by the Contractor.

Regular Dealer - A firm that owns, operates, or maintains a store, warehouse, or other establishment in which the materials or supplies required for the performance of the contract are bought, kept in stock, and regularly sold to the public in the usual course of business. A regular dealer engages in, as its principal business and in its own name, the purchase and sale or lease of the products in question. A regular dealer in such bulk items as steel, cement, gravel, stone, and petroleum products need not keep such products in stock, if it owns and operates distribution equipment for the products. Brokers and packagers are not regarded as manufacturers or regular dealers within the meaning of this section.

Replacement / Substitution – A full or partial reduction in the amount of work subcontracted to a committed (or an approved substitute) DBE firm.

North Carolina Unified Certification Program (NCUCP) - A program that provides comprehensive services and information to applicants for DBE certification, such that an applicant is required to apply only once for a DBE certification that will be honored by all recipients of USDOT funds in the state and not limited to the Department of Transportation only. The Certification Program is in accordance with 49 CFR Part 26.

United States Department of Transportation (USDOT) - Federal agency responsible for issuing regulations (49 CFR Part 26) and official guidance for the DBE program.

Forms and Websites Referenced in this Provision

DBE Payment Tracking System - On-line system in which the Contractor enters the payments made to DBE subcontractors who have performed work on the project.
<https://apps.dot.state.nc.us/Vendor/PaymentTracking/>

DBE-IS Subcontractor Payment Information - Form for reporting the payments made to all DBE firms working on the project. This form is for paper bid projects only.
<https://connect.ncdot.gov/business/Turnpike/Documents/Form%20DBE-IS%20Subcontractor%20Payment%20Information.pdf>

RF-1 DBE Replacement Request Form - Form for replacing a committed DBE.

<http://connect.ncdot.gov/projects/construction/Construction%20Forms/DBE%20MBE%20WBE%20Replacement%20Request%20Form.pdf>

SAF Subcontract Approval Form - Form required for approval to sublet the contract.
<http://connect.ncdot.gov/projects/construction/Construction%20Forms/Subcontract%20Approval%20Form%20Rev.%202012.zip>

JC-1 Joint Check Notification Form - Form and procedures for joint check notification. The form acts as a written joint check agreement among the parties providing full and prompt disclosure of the expected use of joint checks.

<http://connect.ncdot.gov/projects/construction/Construction%20Forms/Joint%20Check%20Notification%20Form.pdf>

Letter of Intent - Form signed by the Contractor and the DBE subcontractor, manufacturer or regular dealer that affirms that a portion of said contract is going to be performed by the signed DBE for the estimated amount (based on quantities and unit prices) listed at the time of bid.

<http://connect.ncdot.gov/letting/LetCentral/Letter%20of%20Intent%20to%20Perform%20as%20a%20Subcontractor.pdf>

Listing of DBE Subcontractors Form - Form for entering DBE subcontractors on a project that will meet this DBE goal. This form is for paper bids only.

[http://connect.ncdot.gov/municipalities/Bid%20Proposals%20for%20LGA%20Content/08%20DBE%20Subcontractors%20\(Federal\).docx](http://connect.ncdot.gov/municipalities/Bid%20Proposals%20for%20LGA%20Content/08%20DBE%20Subcontractors%20(Federal).docx)

Subcontractor Quote Comparison Sheet - Spreadsheet for showing all subcontractor quotes in the work areas where DBEs quoted on the project. This sheet is submitted with good faith effort packages.

<http://connect.ncdot.gov/business/SmallBusiness/Documents/DBE%20Subcontractor%20Quote%20Comparison%20Example.xls>

DBE Goal

The following DBE goal for participation by Disadvantaged Business Enterprises is established for this contract:

Disadvantaged Business Enterprises **0.0** %

- (A) *If the DBE goal is more than zero*, the Contractor shall exercise all necessary and reasonable steps to ensure that DBEs participate in at least the percent of the contract as set forth above as the DBE goal.
- (B) *If the DBE goal is zero*, the Contractor shall make an effort to recruit and use DBEs during the performance of the contract. Any DBE participation obtained shall be reported to the Department.

Directory of Transportation Firms (Directory)

Real-time information is available about firms doing business with the Department and firms that are certified through NCUCP in the Directory of Transportation Firms. Only firms identified in the Directory as DBE certified shall be used to meet the DBE goal. The Directory can be found at the following link. [https:// www.ebs.nc.gov/VendorDirectory/default.html](https://www.ebs.nc.gov/VendorDirectory/default.html)

The listing of an individual firm in the directory shall not be construed as an endorsement of the firm's capability to perform certain work.

Listing of DBE Subcontractors

At the time of bid, bidders shall submit all DBE participation that they anticipate to use during the life of the contract. Only those identified to meet the DBE goal will be considered committed, even though the listing shall include both committed DBE subcontractors and additional DBE subcontractors. Additional DBE subcontractor participation submitted at the time of bid will be used toward the Department's overall race-neutral goal. Only those firms with current DBE certification at the time of bid opening will be acceptable for listing in the bidder's submittal of DBE participation. The Contractor shall indicate the following required information:

(A) Electronic Bids

Bidders shall submit a listing of DBE participation in the appropriate section of the electronic submittal file.

- (1) Submit the names and addresses of DBE firms identified to participate in the contract. If the bidder uses the updated listing of DBE firms shown in the electronic submittal file, the bidder may use the dropdown menu to access the name and address of the DBE firm.
- (2) Submit the contract line numbers of work to be performed by each DBE firm. When no figures or firms are entered, the bidder will be considered to have no DBE participation.
- (3) The bidder shall be responsible for ensuring that the DBE is certified at the time of bid by checking the Directory of Transportation Firms. If the firm is not certified at the time of the bid-letting, that DBE's participation will not count towards achieving the DBE goal.

(B) Paper Bids

- (1) *If the DBE goal is more than zero,*
 - (a) Bidders, at the time the bid proposal is submitted, shall submit a listing of DBE participation, including the names and addresses on *Listing of DBE Subcontractors* contained elsewhere in the contract documents in

order for the bid to be considered responsive. Bidders shall indicate the total dollar value of the DBE participation for the contract.

- (b) If bidders have no DBE participation, they shall indicate this on the *Listing of DBE Subcontractors* by entering the word “None” or the number “0.” This form shall be completed in its entirety. **Blank forms will not be deemed to represent zero participation.** Bids submitted that do not have DBE participation indicated on the appropriate form will not be read publicly during the opening of bids. The Department will not consider these bids for award and the proposal will be rejected.
 - (c) The bidder shall be responsible for ensuring that the DBE is certified at the time of bid by checking the Directory of Transportation Firms. If the firm is not certified at the time of the bid-letting, that DBE’s participation will not count towards achieving the DBE goal.
- (2) *If the DBE goal is zero, entries on the Listing of DBE Subcontractors are not required, however any DBE participation that is achieved during the project shall be reported in accordance with requirements contained elsewhere in the special provision.*

DBE Prime Contractor

When a certified DBE firm bids on a contract that contains a DBE goal, the DBE firm is responsible for meeting the goal or making good faith efforts to meet the goal, just like any other bidder. In most cases, a DBE bidder on a contract will meet the DBE goal by virtue of the work it performs on the contract with its own forces. However, all the work that is performed by the DBE bidder and any other DBE subcontractors will count toward the DBE goal. The DBE bidder shall list itself along with any DBE subcontractors, if any, in order to receive credit toward the DBE goal.

For example, if the DBE goal is 45% and the DBE bidder will only perform 40% of the contract work, the prime will list itself at 40%, and the additional 5% shall be obtained through additional DBE participation with DBE subcontractors or documented through a good faith effort.

DBE prime contractors shall also follow Sections A or B listed under *Listing of DBE Subcontractor* just as a non-DBE bidder would.

Written Documentation – Letter of Intent

The bidder shall submit written documentation for each DBE that will be used to meet the DBE goal of the contract, indicating the bidder’s commitment to use the DBE in the contract. This documentation shall be submitted on the Department’s form titled *Letter of Intent*.

The documentation shall be received in the office of the Engineer no later than 2:00 p.m. of the fifth calendar day following opening of bids, unless the fifth day falls on Saturday, Sunday or an

official state holiday. In that situation, it is due in the office of the Engineer no later than 10:00 a.m. on the next official state business day.

If the bidder fails to submit the Letter of Intent from each committed DBE to be used toward the DBE goal, or if the form is incomplete (i.e. both signatures are not present), the DBE participation will not count toward meeting the DBE goal. If the lack of this participation drops the commitment below the DBE goal, the Contractor shall submit evidence of good faith efforts, completed in its entirety, to the Engineer no later than 2:00 p.m. on the eighth calendar day following opening of bids, unless the eighth day falls on Saturday, Sunday or an official state holiday. In that situation, it is due in the office of the Engineer no later than 10:00 a.m. on the next official state business day.

Submission of Good Faith Effort

If the bidder fails to meet or exceed the DBE goal the apparent lowest responsive bidder shall submit to the Department documentation of adequate good faith efforts made to reach the DBE goal.

One complete set and **FIVE** copies of this information shall be received in the office of the Engineer no later than 2:00 p.m. of the fifth calendar day following opening of bids, unless the fifth day falls on Saturday, Sunday or an official state holiday. In that situation, it is due in the office of the Engineer no later than 10:00 a.m. on the next official state business day.

Note: Where the information submitted includes repetitious solicitation letters, it will be acceptable to submit a representative letter along with a distribution list of the firms that were solicited. Documentation of DBE quotations shall be a part of the good faith effort submittal. This documentation may include written subcontractor quotations, telephone log notations of verbal quotations, or other types of quotation documentation.

Consideration of Good Faith Effort for Projects with DBE Goals More Than Zero

Adequate good faith efforts mean that the bidder took all necessary and reasonable steps to achieve the goal which, by their scope, intensity, and appropriateness, could reasonably be expected to obtain sufficient DBE participation. Adequate good faith efforts also mean that the bidder actively and aggressively sought DBE participation. Mere *pro forma* efforts are not considered good faith efforts.

The Department will consider the quality, quantity, and intensity of the different kinds of efforts a bidder has made. Listed below are examples of the types of actions a bidder will take in making a good faith effort to meet the goal and are not intended to be exclusive or exhaustive, nor is it intended to be a mandatory checklist.

- (A) Soliciting through all reasonable and available means (e.g. attendance at pre-bid meetings, advertising, written notices, use of verifiable electronic means through the use of the NCDOT Directory of Transportation Firms) the interest of all certified DBEs who have the capability to perform the work of the contract. The bidder must solicit this interest within

at least 10 days prior to bid opening to allow the DBEs to respond to the solicitation. Solicitation shall provide the opportunity to DBEs within the Division and surrounding Divisions where the project is located. The bidder must determine with certainty if the DBEs are interested by taking appropriate steps to follow up initial solicitations.

- (B) Selecting portions of the work to be performed by DBEs in order to increase the likelihood that the DBE goals will be achieved.
 - (1) Where appropriate, break out contract work items into economically feasible units to facilitate DBE participation, even when the prime contractor might otherwise prefer to perform these work items with its own forces.
 - (2) Negotiate with subcontractors to assume part of the responsibility to meet the contract DBE goal when the work to be sublet includes potential for DBE participation (2nd and 3rd tier subcontractors).
- (C) Providing interested DBEs with adequate information about the plans, specifications, and requirements of the contract in a timely manner to assist them in responding to a solicitation.
- (D)
 - (1) Negotiating in good faith with interested DBEs. It is the bidder's responsibility to make a portion of the work available to DBE subcontractors and suppliers and to select those portions of the work or material needs consistent with the available DBE subcontractors and suppliers, so as to facilitate DBE participation. Evidence of such negotiation includes the names, addresses, and telephone numbers of DBEs that were considered; a description of the information provided regarding the plans and specifications for the work selected for subcontracting; and evidence as to why additional agreements could not be reached for DBEs to perform the work.
 - (2) A bidder using good business judgment would consider a number of factors in negotiating with subcontractors, including DBE subcontractors, and would take a firm's price and capabilities as well as contract goals into consideration. However, the fact that there may be some additional costs involved in finding and using DBEs is not in itself sufficient reason for a bidder's failure to meet the contract DBE goal, as long as such costs are reasonable. Also, the ability or desire of a prime contractor to perform the work of a contract with its own organization does not relieve the bidder of the responsibility to make good faith efforts. Bidding contractors are not, however, required to accept higher quotes from DBEs if the price difference is excessive or unreasonable.
- (E) Not rejecting DBEs as being unqualified without sound reasons based on a thorough investigation of their capabilities. The bidder's standing within its industry, membership in specific groups, organizations, or associates and political or social affiliations (for example, union vs. non-union employee status) are not legitimate causes for the rejection or non-solicitation of bids in the bidder's efforts to meet the project goal.

- (F) Making efforts to assist interested DBEs in obtaining bonding, lines of credit, or insurance as required by the recipient or bidder.
- (G) Making efforts to assist interested DBEs in obtaining necessary equipment, supplies, materials, or related assistance or services.
- (H) Effectively using the services of available minority/women community organizations; minority/women contractors' groups; Federal, State, and local minority/women business assistance offices; and other organizations as allowed on a case-by-case basis to provide assistance in the recruitment and placement of DBEs. Contact within 7 days from the bid opening the Business Opportunity and Work Force Development Unit at BOWD@ncdot.gov to give notification of the bidder's inability to get DBE quotes.
- (I) Any other evidence that the bidder submits which shows that the bidder has made reasonable good faith efforts to meet the DBE goal.

In addition, the Department may take into account the following:

- (1) Whether the bidder's documentation reflects a clear and realistic plan for achieving the DBE goal.
- (2) The bidders' past performance in meeting the DBE goals.
- (3) The performance of other bidders in meeting the DBE goal. For example, when the apparent successful bidder fails to meet the DBE goal, but others meet it, you may reasonably raise the question of whether, with additional reasonable efforts the apparent successful bidder could have met the goal. If the apparent successful bidder fails to meet the DBE goal, but meets or exceeds the average DBE participation obtained by other bidders, the Department may view this, in conjunction with other factors, as evidence of the apparent successful bidder having made a good faith effort.

If the Department does not award the contract to the apparent lowest responsive bidder, the Department reserves the right to award the contract to the next lowest responsive bidder that can satisfy to the Department that the DBE goal can be met or that an adequate good faith effort has been made to meet the DBE goal.

Non-Good Faith Appeal

The Engineer will notify the contractor verbally and in writing of non-good faith. A contractor may appeal a determination of non-good faith made by the Goal Compliance Committee. If a contractor wishes to appeal the determination made by the Committee, they shall provide written notification to the Engineer. The appeal shall be made within 2 business days of notification of the determination of non-good faith.

Counting DBE Participation Toward Meeting DBE Goal**(A) Participation**

The total dollar value of the participation by a committed DBE will be counted toward the contract goal requirement. The total dollar value of participation by a committed DBE will be based upon the value of work actually performed by the DBE and the actual payments to DBE firms by the Contractor.

(B) Joint Checks

Prior notification of joint check use shall be required when counting DBE participation for services or purchases that involves the use of a joint check. Notification shall be through submission of Form JC-1 (*Joint Check Notification Form*) and the use of joint checks shall be in accordance with the Department's Joint Check Procedures.

(C) Subcontracts (Non-Trucking)

A DBE may enter into subcontracts. Work that a DBE subcontracts to another DBE firm may be counted toward the contract goal requirement. Work that a DBE subcontracts to a non-DBE firm does not count toward the contract goal requirement. If a DBE contractor or subcontractor subcontracts a significantly greater portion of the work of the contract than would be expected on the basis of standard industry practices, it shall be presumed that the DBE is not performing a commercially useful function. The DBE may present evidence to rebut this presumption to the Department. The Department's decision on the rebuttal of this presumption is subject to review by the Federal Highway Administration but is not administratively appealable to USDOT.

(D) Joint Venture

When a DBE performs as a participant in a joint venture, the Contractor may count toward its contract goal requirement a portion of the total value of participation with the DBE in the joint venture, that portion of the total dollar value being a distinct clearly defined portion of work that the DBE performs with its forces.

(E) Suppliers

A contractor may count toward its DBE requirement 60 percent of its expenditures for materials and supplies required to complete the contract and obtained from a DBE regular dealer and 100 percent of such expenditures from a DBE manufacturer.

(F) Manufacturers and Regular Dealers

A contractor may count toward its DBE requirement the following expenditures to DBE firms that are not manufacturers or regular dealers:

- (1) The fees or commissions charged by a DBE firm for providing a *bona fide* service, such as professional, technical, consultant, or managerial services, or for providing bonds or insurance specifically required for the performance of a DOT-assisted contract, provided the fees or commissions are determined to be reasonable and not excessive as compared with fees and commissions customarily allowed for similar services.
- (2) With respect to materials or supplies purchased from a DBE, which is neither a manufacturer nor a regular dealer, count the entire amount of fees or commissions charged for assistance in the procurement of the materials and supplies, or fees or transportation charges for the delivery of materials or supplies required on a job site (but not the cost of the materials and supplies themselves), provided the fees are determined to be reasonable and not excessive as compared with fees customarily allowed for similar services.

Commercially Useful Function

(A) DBE Utilization

The Contractor may count toward its contract goal requirement only expenditures to DBEs that perform a commercially useful function in the work of a contract. A DBE performs a commercially useful function when it is responsible for execution of the work of the contract and is carrying out its responsibilities by actually performing, managing, and supervising the work involved. To perform a commercially useful function, the DBE shall also be responsible with respect to materials and supplies used on the contract, for negotiating price, determining quality and quantity, ordering the material and installing (where applicable) and paying for the material itself. To determine whether a DBE is performing a commercially useful function, the Department will evaluate the amount of work subcontracted, industry practices, whether the amount the firm is to be paid under the contract is commensurate with the work it is actually performing and the DBE credit claimed for its performance of the work, and any other relevant factors.

(B) DBE Utilization in Trucking

The following factors will be used to determine if a DBE trucking firm is performing a commercially useful function:

- (1) The DBE shall be responsible for the management and supervision of the entire trucking operation for which it is responsible on a particular contract, and there shall not be a contrived arrangement for the purpose of meeting DBE goals.

- (2) The DBE shall itself own and operate at least one fully licensed, insured, and operational truck used on the contract.
- (3) The DBE receives credit for the total value of the transportation services it provides on the contract using trucks it owns, insures, and operates using drivers it employs.
- (4) The DBE may subcontract the work to another DBE firm, including an owner-operator who is certified as a DBE. The DBE who subcontracts work to another DBE receives credit for the total value of the transportation services the subcontracted DBE provides on the contract.
- (5) The DBE may also subcontract the work to a non-DBE firm, including from an owner-operator. The DBE who subcontracts the work to a non-DBE is entitled to credit for the total value of transportation services provided by the non-DBE subcontractor not to exceed the value of transportation services provided by DBE-owned trucks on the contract. Additional participation by non-DBE subcontractors receives credit only for the fee or commission it receives as a result of the subcontract arrangement. The value of services performed under subcontract agreements between the DBE and the Contractor will not count towards the DBE contract requirement.
- (6) A DBE may lease truck(s) from an established equipment leasing business open to the general public. The lease must indicate that the DBE has exclusive use of and control over the truck. This requirement does not preclude the leased truck from working for others during the term of the lease with the consent of the DBE, so long as the lease gives the DBE absolute priority for use of the leased truck. This type of lease may count toward the DBE's credit as long as the driver is under the DBE's payroll.
- (7) Subcontracted/leased trucks shall display clearly on the dashboard the name of the DBE that they are subcontracted/leased to and their own company name if it is not identified on the truck itself. Magnetic door signs are not permitted.

DBE Replacement

When a Contractor has relied on a commitment to a DBE subcontractor (or an approved substitute DBE subcontractor) to meet all or part of a contract goal requirement, the contractor shall not terminate the DBE subcontractor for convenience. This includes, but is not limited to, instances in which the Contractor seeks to perform the work of the terminated subcontractor with another DBE subcontractor, a non-DBE subcontractor, or with the Contractor's own forces or those of an affiliate.

The Contractor must give notice in writing both by certified mail and email to the DBE subcontractor, with a copy to the Engineer of its intent to request to terminate and/or substitute, and the reason for the request. The Contractor must give the DBE subcontractor five (5) business days to respond to the Contractor's Notice of Intent to Request Termination and/or Substitution.

If the DBE subcontractor objects to the intended termination/substitution, the DBE, within five (5) business days must advise the Contractor and the Department of the reasons why the action should not be approved. The five-day notice period shall begin on the next business day after written notice is provided to the DBE subcontractor.

A committed DBE subcontractor may only be terminated after receiving the Department's written approval based upon a finding of good cause for the proposed termination and/or substitution. For purposes of this section, good cause shall include the following circumstances:

- (a) The listed DBE subcontractor fails or refuses to execute a written contract;
- (b) The listed DBE subcontractor fails or refuses to perform the work of its subcontract in a way consistent with normal industry standards. Provided, however, that good cause does not exist if the failure or refusal of the DBE subcontractor to perform its work on the subcontract results from the bad faith or discriminatory action of the prime contractor;
- (c) The listed DBE subcontractor fails or refuses to meet the prime contractor's reasonable, nondiscriminatory bond requirements;
- (d) The listed DBE subcontractor becomes bankrupt, insolvent, or exhibits credit unworthiness;
- (e) The listed DBE subcontractor is ineligible to work on public works projects because of suspension and debarment proceedings pursuant to 2 CFR Parts 180, 215 and 1,200 or applicable state law;
- (f) The listed DBE subcontractor is not a responsible contractor;
- (g) The listed DBE voluntarily withdraws from the project and provides written notice of withdrawal;
- (h) The listed DBE is ineligible to receive DBE credit for the type of work required;
- (i) A DBE owner dies or becomes disabled with the result that the listed DBE contractor is unable to complete its work on the contract;
- (j) Other documented good cause that compels the termination of the DBE subcontractor. Provided, that good cause does not exist if the prime contractor seeks to terminate a DBE it relied upon to obtain the contract so that the prime contractor can self-perform the work for which the DBE contractor was engaged or so that the prime contractor can substitute another DBE or non-DBE contractor after contract award.

The Contractor shall comply with the following for replacement of a committed DBE:

(A) Performance Related Replacement

When a committed DBE is terminated for good cause as stated above, an additional DBE that was submitted at the time of bid may be used to fulfill the DBE commitment. A good faith effort will only be required for removing a committed DBE if there were no additional DBEs submitted at the time of bid to cover the same amount of work as the DBE that was terminated.

If a replacement DBE is not found that can perform at least the same amount of work as the terminated DBE, the Contractor shall submit a good faith effort documenting the steps taken. Such documentation shall include, but not be limited to, the following:

- (1) Copies of written notification to DBEs that their interest is solicited in contracting the work defaulted by the previous DBE or in subcontracting other items of work in the contract.
 - (2) Efforts to negotiate with DBEs for specific subbids including, at a minimum:
 - (a) The names, addresses, and telephone numbers of DBEs who were contacted.
 - (b) A description of the information provided to DBEs regarding the plans and specifications for portions of the work to be performed.
 - (3) A list of reasons why DBE quotes were not accepted.
 - (4) Efforts made to assist the DBEs contacted, if needed, in obtaining bonding or insurance required by the Contractor.
- (B) Decertification Replacement
- (1) When a committed DBE is decertified by the Department after the SAF (*Subcontract Approval Form*) has been received by the Department, the Department will not require the Contractor to solicit replacement DBE participation equal to the remaining work to be performed by the decertified firm. The participation equal to the remaining work performed by the decertified firm will count toward the contract goal requirement.
 - (2) When a committed DBE is decertified prior to the Department receiving the SAF (*Subcontract Approval Form*) for the named DBE firm, the Contractor shall take all necessary and reasonable steps to replace the DBE subcontractor with another DBE subcontractor to perform at least the same amount of work to meet the DBE goal requirement. If a DBE firm is not found to do the same amount of work, a good faith effort must be submitted to NCDOT (see A herein for required documentation).
 - (3) Exception: If the DBE's ineligibility is caused solely by its having exceeded the size standard during the performance of the contract, the Department will not require the Contractor to solicit replacement DBE participation equal to the remaining work to be performed by the decertified firm. The participation equal to the remaining work performed by the decertified firm will count toward the contract goal requirement and overall goal.

All requests for replacement of a committed DBE firm shall be submitted to the Engineer for approval on Form RF-1 (*DBE Replacement Request*). If the Contractor fails to follow this procedure, the Contractor may be disqualified from further bidding for a period of up to 6 months

Changes in the Work

When the Engineer makes changes that result in the reduction or elimination of work to be performed by a committed DBE, the Contractor will not be required to seek additional participation. When the Engineer makes changes that result in additional work to be performed by a DBE based upon the Contractor's commitment, the DBE shall participate in additional work to the same extent as the DBE participated in the original contract work.

When the Engineer makes changes that result in extra work, which has more than a minimal impact on the contract amount, the Contractor shall seek additional participation by DBEs unless otherwise approved by the Engineer.

When the Engineer makes changes that result in an alteration of plans or details of construction, and a portion or all of the work had been expected to be performed by a committed DBE, the Contractor shall seek participation by DBEs unless otherwise approved by the Engineer.

When the Contractor requests changes in the work that result in the reduction or elimination of work that the Contractor committed to be performed by a DBE, the Contractor shall seek additional participation by DBEs equal to the reduced DBE participation caused by the changes.

Reports and Documentation

A SAF (*Subcontract Approval Form*) shall be submitted for all work which is to be performed by a DBE subcontractor. The Department reserves the right to require copies of actual subcontract agreements involving DBE subcontractors.

When using transportation services to meet the contract commitment, the Contractor shall submit a proposed trucking plan in addition to the SAF. The plan shall be submitted prior to beginning construction on the project. The plan shall include the names of all trucking firms proposed for use, their certification type(s), the number of trucks owned by the firm, as well as the individual truck identification numbers, and the line item(s) being performed.

Within 30 calendar days of entering into an agreement with a DBE for materials, supplies or services, not otherwise documented by the SAF as specified above, the Contractor shall furnish the Engineer a copy of the agreement. The documentation shall also indicate the percentage (60% or 100%) of expenditures claimed for DBE credit.

Reporting Disadvantaged Business Enterprise Participation

The Contractor shall provide the Engineer with an accounting of payments made to all DBE firms, including material suppliers and contractors at all levels (prime, subcontractor, or second tier subcontractor). This accounting shall be furnished to the Engineer for any given month by the end

of the following month. Failure to submit this information accordingly may result in the following action:

- (A) Withholding of money due in the next partial pay estimate; or
- (B) Removal of an approved contractor from the prequalified bidders' list or the removal of other entities from the approved subcontractors list.

While each contractor (prime, subcontractor, 2nd tier subcontractor) is responsible for accurate accounting of payments to DBEs, it shall be the prime contractor's responsibility to report all monthly and final payment information in the correct reporting manner.

Failure on the part of the Contractor to submit the required information in the time frame specified may result in the disqualification of that contractor and any affiliate companies from further bidding until the required information is submitted.

Failure on the part of any subcontractor to submit the required information in the time frame specified may result in the disqualification of that contractor and any affiliate companies from being approved for work on future projects until the required information is submitted.

Contractors reporting transportation services provided by non-DBE lessees shall evaluate the value of services provided during the month of the reporting period only.

At any time, the Engineer can request written verification of subcontractor payments.

The Contractor shall report the accounting of payments through the Department's DBE Payment Tracking System.

Failure to Meet Contract Requirements

Failure to meet contract requirements in accordance with Subarticle 102-15(J) of the *2018 Standard Specifications* may be cause to disqualify the Contractor.

CERTIFICATION FOR FEDERAL-AID CONTRACTS:

(3-21-90)

SP1 G85

The prospective participant certifies, by signing and submitting this bid or proposal, to the best of his or her knowledge and belief, that:

- (A) No Federal appropriated funds have been paid or will be paid, by or on behalf of the undersigned, to any person for influencing or attempting to influence an officer or employee of any Federal agency, a Member of Congress, an officer or employee of Congress, or an employee of a Member of Congress in connection with the awarding of any Federal contract, the making of any Federal grant, the making of any Federal loan, the entering into of any cooperative agreement, and the extension, continuation, renewal, amendment, or modification of any Federal contract, grant, loan, or cooperative agreement.

- (B) If any funds other than Federal appropriated funds have been paid or will be paid to any person for influencing or attempting to influence an officer or employee of any Federal agency, a Member of Congress, an officer or employee of Congress, or an employee of a Member of Congress in connection with this Federal contract, grant, loan, or cooperative agreement, the undersigned shall complete and submit Standard Form-LLL, *Disclosure Form to Report Lobbying*, in accordance with its instructions.

This certification is a material representation of fact upon which reliance was placed when this transaction was made or entered into. Submission of this certification is a prerequisite for making or entering into this transaction imposed by *Section 1352, Title 31, U.S. Code*. Any person who fails to file the required certification shall be subject to a civil penalty of not less than \$10,000 and not more than \$100,000 for each such failure.

The prospective participant also agrees by submitting his or her bid or proposal that he or she shall require that the language of this certification be included in all lower tier subcontracts, which exceed \$100,000 and that all such subrecipients shall certify and disclose accordingly.

CONTRACTOR'S LICENSE REQUIREMENTS:

(7-1-95)

102-14

SP1 G88

If the successful bidder does not hold the proper license to perform any plumbing, heating, air conditioning, or electrical work in this contract, he will be required to sublet such work to a contractor properly licensed in accordance with *Article 2 of Chapter 87 of the General Statutes* (licensing of heating, plumbing, and air conditioning contractors) and *Article 4 of Chapter 87 of the General Statutes* (licensing of electrical contractors).

RESTRICTIONS ON ITS EQUIPMENT AND SERVICES:

(11-17-20)

SP01 G090

All telecommunications, video or other ITS equipment or services installed or utilized on this project must be in conformance with UNIFORM ADMINISTRATIVE REQUIREMENTS, COST PRINCIPLES, AND AUDIT REQUIREMENTS FOR FEDERAL AWARDS **2 CFR, § 200.216**
Prohibition on certain telecommunications and video surveillance services or equipment.

USE OF UNMANNED AIRCRAFT SYSTEM (UAS):

(8-20-19)

SP1 G092

The Contractor shall adhere to all Federal, State and Local regulations and guidelines for the use of Unmanned Aircraft Systems (UAS). This includes but is not limited to US 14 CFR Part 107 *Small UAS Rule*, NC GS 15A-300.2 *Regulation of launch and recovery sites*, NC GS 63-95 *Training required for the operation of unmanned aircraft systems*, NC GS 63-96 *Permit required for commercial operation of unmanned aircraft system*, and NCDOT UAS Policy. The required operator certifications include possessing a current Federal Aviation Administration (FAA) Remote Pilot Certificate, a NC UAS Operator Permit as well as operating a UAS registered with the FAA.

Prior to beginning operations, the Contractor shall complete the NCDOT UAS – Flight Operation Approval Form and submit it to the Engineer for approval. All UAS operations shall be approved by the Engineer prior to beginning the operations.

All contractors or subcontractors operating UAS shall have UAS specific general liability insurance to cover all operations under this contract.

The use of UAS is at the Contractor's discretion. No measurement or payment will be made for the use of UAS. In the event that the Department directs the Contractor to utilize UAS, payment will be in accordance with Article 104-7 Extra Work.

EQUIPMENT IDLING GUIDELINES:

(1-19-21)

107

SP1 G096

Exercise reduced fuel consumption and reduced equipment emissions during the construction of all work associated with this contract. Employees engaged in the construction of this project should turn off vehicles when stopped for more than thirty (30) minutes and off-highway equipment should idle no longer than fifteen (15) consecutive minutes.

These guidelines for turning off vehicles and equipment when idling do not apply to:

1. Idling when queuing.
2. Idling to verify the vehicle is in safe operating condition.
3. Idling for testing, servicing, repairing or diagnostic purposes.
4. Idling necessary to accomplish work for which the vehicle was designed (such as operating a crane, mixing concrete, etc.).
5. Idling required to bring the machine system to operating temperature.
6. Emergency vehicles, utility company, construction, and maintenance vehicles where the engines must run to perform needed work.
7. Idling to ensure safe operation of the vehicle.
8. Idling when the propulsion engine is providing auxiliary power for other than heating or air conditioning. (such as hydraulic systems for pavers)
9. When specific traffic, safety, or emergency situations arise.
10. If the ambient temperature is less than 32 degrees Fahrenheit. Limited idling to provide for the safety of vehicle occupants (e.g. to run the heater).
11. If the ambient temperature is greater than 90 degrees Fahrenheit. Limited idling to provide for the safety of vehicle occupants of off-highway equipment (e.g. to run the air conditioning) no more than 30 minutes.
12. Diesel powered vehicles may idle for up to 30 minutes to minimize restart problems.

Any vehicle, truck, or equipment in which the primary source of fuel is natural gas or electricity is exempt from the idling limitations set forth in this special provision.

U.S. DEPARTMENT OF TRANSPORTATION HOTLINE:

(11-22-94)

108-5

SP1 G100

To report bid rigging activities call: **1-800-424-9071**

The U.S. Department of Transportation (DOT) operates the above toll-free hotline Monday through Friday, 8:00 a.m. to 5:00 p.m. eastern time. Anyone with knowledge of possible bid rigging, bidder collusion, or other fraudulent activities should use the hotline to report such activities.

The hotline is part of the DOT's continuing effort to identify and investigate highway construction contract fraud and abuse is operated under the direction of the DOT Inspector General. All information will be treated confidentially and caller anonymity will be respected.

ELECTRONIC BIDDING:

(2-19-19)

101, 102, 103

SP1 G140

Revise the *2018 Standard Specifications* as follows:

Page 1-4, Article 101-3, DEFINITIONS, BID (OR PROPOSAL) *Electronic Bid*, line 1, replace “Bid Express®” with “the approved electronic bidding provider”.

Page 1-15, Subarticle 102-8(B), *Electronic Bids*, lines 39-40, replace “to Bid Express®” with “via the approved electronic bidding provider”.

Page 1-15, Subarticle 102-8(B)(1), *Electronic Bids*, line 41, delete “from Bid Express®”

Page 1-17, Subarticle 102-9(C)(2), *Electronic Bids*, line 21, replace “Bid Express® miscellaneous folder within the .ebs” with “electronic submittal”.

Page 1-29, Subarticle 103-4(C)(2), *Electronic Bids*, line 32, replace “.ebs miscellaneous data file of Expedite” with “electronic submittal file”

AWARD LIMITS:

(4-19-22)

103

SP1 G141

Revise the *2018 Standard Specifications* as follows:

Page 1-29, Subarticle 103-4(C), *Award Limits*, line 4-8, delete and replace the first sentence in the first paragraph with the following:

A bidder who desires to bid on more than one project on which bids are to be opened in the same letting and who desires to avoid receiving an award of more projects than he is equipped to handle, may bid on any number of projects but may limit the total amount of work awarded to him on selected projects by completing the form Award Limits on Multiple Projects for each project subject to the award limit.

REVISION TO FHWA-1273 CONCERNING TAP-FUNDED PROJECTS:

(10-15-13)

SP1 G190

Revise the *Standard Special Provision FHWA-1273 Required Contract Provisions Federal-Aid Construction Contracts* as follows:

Replace the last sentence in Section I.4 and the third sentence in the first paragraph of Section IV with the following:

Transportation Alternative Program (TAP)-funded projects shall have the same requirements as Federal-Aid highway projects except physical location exceptions will not apply.

PROJECT SPECIAL PROVISIONS

ROADWAY

BURNING RESTRICTIONS:

(7-1-95)

200, 210, 215

SP2 R05

Open burning is not permitted on any portion of the right-of-way limits established for this project. Do not burn the clearing, grubbing or demolition debris designated for disposal and generated from the project at locations within the project limits, off the project limits or at any waste or borrow sites in this county. Dispose of the clearing, grubbing and demolition debris by means other than burning, according to state or local rules and regulations.

MATERIAL AND EQUIPMENT STORAGE & PARKING OF PERSONAL VEHICLES:

11-17-21(Rev. 8-16-22)

1101

SP11 R03

Revise the *2018 Standard Specifications* as follows:

Page 11-2, Article 1101-8 MATERIAL AND EQUIPMENT STORAGE, line 35-38, delete and replace with the following:

When work is not in progress, keep all personnel, equipment, machinery, tools, construction debris, materials and supplies away from active travel lanes that meets Table 1101-1.

TABLE 1101-1	
MATERIAL AND EQUIPMENT STORAGE FROM ACTIVE TRAVEL LANES	
Posted Speed Limit (mph)	Distance (ft)
40 or less	≥ 18
45-50	≥ 28
55	≥ 32
60 or higher	≥ 40

When vehicles, equipment and materials are protected by concrete barrier or guardrail, they shall be offset at least 5 feet from the barrier or guardrail.

Page 11-2, Article 1101-9 PARKING OF PERSONAL VEHICLES, line 40-41, delete and replace with the following:

Provide staging areas for personal vehicle parking in accordance with Article 1101-8 or as directed by the Engineer before use.

LAW ENFORCEMENT:

(6-21-22)(Rev. 11-15-22)

1190

SP11 R30

Revise the *2018 Standard Specifications* as follows:

Page 11-19, Article 1190-1 DESCRIPTION, lines 4-5, replace the paragraph with the following:

Furnish Law Enforcement Officers and official Law Enforcement vehicles to direct traffic in accordance with the contract.

Page 11-19, Article 1190-2 CONSTRUCTION METHODS, lines 7-10, replace the first and second paragraph with the following:

Use off duty uniformed Law Enforcement Officers and official Law Enforcement vehicles equipped with blue lights to direct or control traffic as required by the plans or by the Engineer.

Law Enforcement vehicles shall not be parked within the buffer space on any roadway. Law Enforcement vehicles shall not be used to close or block an active travel lane on multilane roadways with a posted speed limit of 45 MPH or higher, except as allowed during rolling roadblock operations as shown in the *Roadway Standard Drawings* or while responding to an emergency.

Page 11-19, Article 1190-3 MEASUREMENT AND PAYMENT, lines 14-15, replace the second sentence of the first paragraph with the following:

There will be no direct payment for official Law Enforcement vehicles as they are considered incidental to the pay item.

WORK ZONE INSTALLER:

(7-20-21)(Rev. 8-16-22)

1101, 1150

SP11 R04

Provide the service of at least one qualified work zone installer during the setup, installation, and removal of temporary traffic control within the highway right of way. The qualified work zone installer shall serve as crew leader and shall be on site and directing the installation and removal of temporary traffic control. If multiple temporary traffic control installations or removals are occurring simultaneously, then each shall have a qualified work zone installer.

The work zone installer shall be qualified by an NCDOT approved training agency or other NCDOT approved training provider in the safe and competent set up of temporary traffic control. For a complete listing of approved training agencies, see the Work Zone Safety Training webpage.

A work zone supervisor, in accordance with Article 1101-13 of the *Standard Specifications*, may fulfill the role of the work zone installer during the setup, installation, and removal of temporary traffic control within the highway right of way provided they are on site and directing the installation and removal of temporary traffic control.

All other individuals participating in the setup, installation, and removal of temporary traffic control within the highway right of way shall be certified as a qualified flagger in accordance with Article 1150-3 of the *Standard Specifications*, even if flagging is not being performed as part of the traffic control.

Provide the name and contact information of all qualified work zone installers to the Engineer prior to or at the preconstruction conference. Additionally, provide a qualification statement that all other individuals participating in the setup, installation, and removal of temporary traffic control are qualified flaggers that

have been properly trained through an NCDOT approved training agency or other NCDOT approved training provider.

All certification records for qualified work zone installers and flaggers shall be uploaded by the approved training agency or other NCDOT approved training provider to the Department's Work Zone Education Verification App (WZ-EVA) prior to the qualified work zone installer or flagger performing any traffic control duties on the project. For more information about WZ-EVA, see the Work Zone Safety Training webpage.

STANDARD SPECIAL PROVISION**AVAILABILITY OF FUNDS – TERMINATION OF CONTRACTS**

(5-20-08)

Z-2

General Statute 143C-6-11. (h) Highway Appropriation is hereby incorporated verbatim in this contract as follows:

(h) Amounts Encumbered. – Transportation project appropriations may be encumbered in the amount of allotments made to the Department of Transportation by the Director for the estimated payments for transportation project contract work to be performed in the appropriation fiscal year. The allotments shall be multiyear allotments and shall be based on estimated revenues and shall be subject to the maximum contract authority contained in *General Statute 143C-6-11(c)*. Payment for transportation project work performed pursuant to contract in any fiscal year other than the current fiscal year is subject to appropriations by the General Assembly. Transportation project contracts shall contain a schedule of estimated completion progress, and any acceleration of this progress shall be subject to the approval of the Department of Transportation provided funds are available. The State reserves the right to terminate or suspend any transportation project contract, and any transportation project contract shall be so terminated or suspended if funds will not be available for payment of the work to be performed during that fiscal year pursuant to the contract. In the event of termination of any contract, the contractor shall be given a written notice of termination at least 60 days before completion of scheduled work for which funds are available. In the event of termination, the contractor shall be paid for the work already performed in accordance with the contract specifications.

Payment will be made on any contract terminated pursuant to the special provision in accordance with Subarticle 108-13(D) of the *2018 Standard Specifications*.

STANDARD SPECIAL PROVISIONERRATA

(10-16-18) (Rev. 4-18-23)

Z-4

Revise the *2018 Standard Specifications* as follows:

Division 1

Page 1-1, Article 101-2 Abbreviations, line 13, replace " American National Standards Institute, Inc." with "American National Standards Institute".

Page 1-1, Article 101-2 Abbreviations, line 32, replace "Equivalent Single Axis Load" with "Equivalent Single Axle Load".

Page 1-16, Subarticle 102-9(A) General, line 26, replace "10 U.S.C. 2304(g)" with "10 U.S.C. 3205".

Page 1-43, Article 104-13 RECYCLED PRODUCTS OR SOLID WASTE MATERIALS, line 4, replace "104-13(B)(2)" with "104-13(B)".

Page 1-52, Article 106-1 RECYCLED PRODUCTS OR SOLID WASTE MATERIALS, line 25, replace "13 NCAC 7CF.0101(a)(99)" with "29 CFR 1910.1200".

Page 1-79, Article 109-1 MEASUREMENT AND PAYMENT, Test Method prior to line 34, replace "AASHTO M 32" with "AASHTO M 336".

Division 2

Page 2-5, Article 210-2 CONSTRUCTION METHODS, line 21, replace " NCGS §§ 130A-444 to -452" with "NCGS §§ 130A-444 to -453".

Page 2-13, Article 225-2 EROSION CONTROL REQUIREMENTS, line 17, replace "the Sedimentation and Pollution Control Act" with "Article 107-12".

Page 2-20, Subarticle 230-4(B)(3) Reclamation Plan, line 12, replace " Department's borrow and waste site reclamation procedures for contracted projects" with "Department's *Borrow Waste and Staging Site Reclamation Procedures for Contract Projects*".

Page 2-25, Subarticle 235-3(E) Surcharges and Waiting Periods, line 21 and 27, delete "Department's Materials and Tests Unit."

Page 2-27, Article 240-4 MEASUREMENT AND PAYMENT, line 23, replace "Section 225" with "Article 225-7".

Page 2-30, Article 275-4 MEASUREMENT AND PAYMENT, line 33, replace "Section 815" with "Article 815-4".

Division 4

Page 4-18, Subarticle 411-5(C)(3) Coring, line 11, replace “in accordance with ASTM D5079” with “with methods acceptable to the Engineer”.

Page 4-50, Article 430-2 MATERIALS, prior to line 15, replace Section “1080-9” with “1080-7”.

Page 4-53, Article 440-2 MATERIALS, prior to line 6, replace Section “1080-9” with “1080-7”.

Page 4-58, Article 442-2 MATERIALS, prior to line 15, replace Section “1080-6” with “1080-12”.

Page 4-59, Subarticle 442-7(A) Blast Cleaning, line 36, replace Article “1080-6” with “1080-12”.

Page 4-76, Article 454-2 MATERIALS, prior to line 24, replace Section “815-2” with “1044”.

Page 4-79, Article 455-2 MATERIALS, prior to line 21, replace Section “815” with “1044”.

Page 4-80, Subarticle 455-3(B) Precast Gravity Wall Designs, line 23 and lines 25-26, replace “AASHTO LRFD specifications” with “*AASHTO LRFD Bridge Design Specifications*”.

Page 4-84, Article 458-5 MEASUREMENT AND PAYMENT, line 31, replace article number “454-1” with “458-1”.

Division 6

Page 6-7, Article 609-1 DESCRIPTION, line 29, replace article number “609-10” with “609-9”.

Page 6-10, Subarticle 609-6(C) Control Charts, line 17, replace Section number “7021” with “7.20.1”.

Page 6-13, Article 609-9 QUALITY ASSURANCE, line 31, replace Section number “7.60” with “7.6”.

Page 6-26, Subarticle 610-13(A)(1) Acceptance for New Construction, line 31, replace Table number “610-7” with “610-8”.

Page 6-29, Subarticle 610-13(B) North Carolina Hearne Straightedge, line 32, replace Table number “610-8” with “610-9”.

Page 6-31, Article 610-14 DENSITY ACCEPTANCE, Specified Density prior to line 30 and line 32, replace Table number “610-6” with “610-7”.

Page 6-37, Article 650-5 CONSTRUCTION METHODS, line 10, replace Section number “9.5(E)” with “9.5.1(E)”.

Page 6-44, Subarticle 660-8(B) Asphalt Mat and Seal, line 40, replace Subarticle number “660-8(A)” with “660-8(C)”.

Page 6-44, Subarticle 660-8(B) Asphalt Mat and Seal, line 42, replace Subarticle number “660-8(C)” with “660-8(A)”.

Division 7

Page 7-11, Subarticle 700-15(E) Compressive Strength, line 5, replace “AASHTO T 23” with “AASHTO R 100”.

Page 7-24, Article 723-4 Very High Early Strength Concrete for Concrete Pavement Repair, line 4, replace “AASHTO T126” with “AASHTO R 39”.

Page 7-24, Article 723-5 MEASUREMENT AND PAYMENT, line 34, replace "Section 225" with “Article 225-7”.

Page 7-24, Article 723-5 MEASUREMENT AND PAYMENT, line 36, replace "Section 270" with “Article 270-4”.

Page 7-27, Article 725-1 MEASUREMENT AND PAYMENT, line 4, replace article number “725-1” with “724-4”.

Page 7-28, Article 725-1 MEASUREMENT AND PAYMENT, line 10, replace article number “725-1” with “725-3”.

Division 8

Page 8-11, Article 815-1 MATERIALS, after line 35, replace “1080-12” with “1080-10”.

Page 8-13, Article 816-1 MATERIALS, after line 28, replace “1080-12” with “1080-10”.

Page 8-17, Article 825-1 Description, line 5, delete “853” and “855”.

Division 10

Page 10-2, Subarticle 1000-3(B) Air Entrainment, line 33, replace “Chase” with “Chace”.

Page 10-4, Subarticle 1000-4(A) Composition and Design, after line 17, replace “T23” with “R100”.

Page 10-4, Subarticle 1000-4(B) Air Entrainment, line 31 and 33, replace “Chase” with “Chace”.

Page 10-4, Subarticle 1000-4(C) Strength of Concrete, line 39 and 41, replace “T 23” with “R 100”.

Page 10-15, Subarticle 1000-11(B) Mixing Time for Central Mixed Concrete, after line 35, replace “T 23” with “R 100”.

Page 10-22, Article 1003-3 COMPOSITION AND DESIGN, line 9, replace “Engineer” with “engineer”.

Page 10-23, Article 1003-4 GROUT REQUIREMENTS, line 16 and 18, replace “T 23” with “R 100”.

Page 10-26, Article 1005-4 TESTING, after line 26, replace “1014-2€(6)” with “1014-2€(6)” in C. of Table 1005-1 footnote and replace “Lightweight^B” with “Lightweight^C”.

Page 10-29, Subarticle 1012-1(B)(4) Flat and Elongated Pieces, line 44, delete “SF9.5A”

Page 10-36, Subarticle 1012-2(E) Toughness (Resistance to Abrasion), line 31, replace “course” with “coarse”.

Page 10-37, Article 1012-4, LIGHTWEIGHT AGGREGATE, line 4, replace Table number “1012-8” with “1012-5”.

Page 10-48, Subarticle 1020-10(A) Mineral Fibers, line 27, replace “Table 1012-5” with “Table 1020-2”.

Page 10-52, Article 1024-5 FLY ASH, line 12, replace “Table 2” with “Table 3”.

Page 10-60, Subarticle 1032-6(F) Joint Materials, line 15, replace “AASHTO M 198” with “ASTM C990” and delete “Type B”.

Page 10-61, Article 1034-3 CONCRETE SEWER PIPE, line 33, replace “AASHTO M 198” with “ASTM C990” and delete “Type A or B”.

Page 10-64, Article 1040-1 BRICK, line 12, replace “ASTM C62” with “ASTM C62 or ASTM C216”.

Page 10-67, Article 1044-7 CORRUGATED PLASTIC PIPE AND FITTINGS, line 24, replace “AASHTO M 294 for heavy duty tubing” with “Article 1032-7 and AASHTO M 252”.

Page 10-69, Subarticle 1046-3(D) Offset Blocks, before line 1, replace “WIRE DIAMETER” with “COMPOSITE OFFSET BLOCKS” as the title of Table 1046-1 and replace “NCHRP Report 350” with “MASH” in Table 1046-1.

Page 10-80, Article 1060-2 FERTILIZER, line 18, replace “North Carolina Fertilizer Law” with “North Carolina Commercial Fertilizer Law”.

Page 10-83, Article 1060-9 WATER, line 9, replace “15 NCAC 2B.0200” with “15A NCAC 02B.0200”.

Page 10-86, Article 1070-3 COLD DRAWN STEEL WIRE AND WIRE REINFORCEMENT, line 23 and 25, replace “M 32” and “M 55” with “M 336”.

Page 10-87, Article 1070-6 DOWELS AND TIE BARS FOR PORTLAND CEMENT CONCRETE PAVEMENT, line 17, replace “AASHTO M 32” with “AASHTO M 336”.

Page 10-88, Subarticle 1070-7(D) Handling, Storage and Transportation, line 40, replace “Section” with “Subarticle”.

Page 10-89, Article 1070-8 SPIRAL COLUMN REINFORCING STEEL, line 21, replace “AASHTO M 32” with “AASHTO M 336”.

Page 10-91, Article 1072-3 BEARING PLATE ASSEMBLIES, line 44, replace “Article 1080-9” with “Article 1080-7”.

Page 10-92, Subarticle 1072-5(A) General, after line 30, replace “SAMPLING REQUIREMENTS FOR HIGH STRENGTH BOLTS, NUTS AND WASHERS” with “SAMPLING REQUIREMENTS FOR HIGH STRENGTH BOLTS, NUTS AND WASHERS TO INCLUDE DIRECT TENSION INDICATORS” as the title of Table 1072-1.

Page 10-95, Subarticle 1072-5(D)(7)(a) Mill Test Report(s), line 18, replace title with “Mill Test Report(s) (MTR)”.

Page 10-95, Subarticle 1072-5(D)(7)(b) Manufacturer Certified Test Report(s), line 24, replace title with “Manufacturer Certified Test Report(s) (MCTR)”.

Page 10-96, Subarticle 1072-5(D)(7)(c) Distributor Certified Test Report(s), line 1, replace title with “Distributor Certified Test Report(s) (DCTR)”.

Page 10-98, Subarticle 1072-5(F) Galvanized High Strength Bolts, Nuts and Washers, line 11, replace “Article 1080-9” with “Article 1080-7”.

Page 10-98, Subarticle 1072-5(F) Galvanized High Strength Bolts, Nuts and Washers, line 11, replace “Article 1080-9” with “Article 1080-7”.

Page 10-111, Subarticle 1072-18(B) General, line 24, replace “Structural Welding Code- Reinforcing Steel” with “Structural Welding Code-Steel Reinforcing Bars”.

Page 10-117, Article 1074-1 WELDING, lines 21-22, replace “Structural Welding Code- Reinforcing Steel” with “Structural Welding Code-Steel Reinforcing Bars”.

Page 10-119, Article 1074-7(B) Gray Iron Castings, line 16, replace “M306” with “AASHTO M 306”.

Page 10-121, Article 1076-7, REPAIR OF GALVANIZING, line 8, replace article number “1080-9” with “1080-7”.

Page 10-125, Subarticle 1077-5(B) Testing, line 31, replace “T 23” with “R 100”.

Page 10-136, Subarticle 1077-5(J)(2) Mixing Time for Central Mixed Concrete, after line 17, replace “T23” with “R100”.

Page 10-131, Subarticle 1078-4(A) Composition and Design, after line 23, in Table 1078-2 replace “T 23” with “R 100”.

Page 10-153, Subarticle 1079-1 PREFORMED BEARING PADS, line 8, replace “MIL-C882-D” with “MIL-C-882-E”.

Page 10-154, Subarticle 1079-2(A) General, line 6, delete “and 1079-2(E)”.

Page 10-156, Article 1080-5 SELF-CURING INORGANIC ZINC PAINT, line 8, replace “AASHTO M 252” with “AASHTO M 300”.

Page 10-156, Article 1080-5 SELF-CURING INORGANIC ZINC PAINT, line 20, replace “AASHTO M 253” with “AASHTO M 300”.

Page 10-156, Subarticle 1080-9(A) Composition, line 40, replace “Tables 1080-7 through 1080-14” with “Tables 1080-1 through 1080-3”.

Page 10-157, Subarticle 1080-9(B) Properties, line 5, replace “Tables 1080-7 through 1080-14” with “Tables 1080-1 through 1080-3”.

Page 10-157, Subarticle 1080-9(B) Properties, line 35, replace “Materials and Tests Standards CLS-P-1.0” with “*Structural Steel Shop Coatings Program*”.

Page 10-159, Subarticle 1080-9(E) Color Variation, Table 1080-1, replace “ASTM D1159” with “ASTM D1199”.

Page 10-159, Subarticle 1080-9(E) Color Variation, Table 1080-1, replace “NCDOT M&T P-10” with “ASTM D6280”.

Page 10-161, Subarticle 1080-9(E) Color Variation, Table 1080-3, replace “ASTM D13278” and “ASTM D3278”.

Page 10-161, Subarticle 1080-9(E) Color Variation, Table 1080-3, replace “NCDOT M&T P-10” and “Structural Steel Shop Coatings Program”.

Page 10-161, Subarticle 1080-9(E) Color Variation, Table 1080-3, add Test Method “ASTM D4400” for the Leneta Sag Test property in Table 1080-3.

Page 10-161, Subarticle 1080-9(E) Color Variation, Table 1080-3, add Test Method “ASTM D523” for the Gloss, Specular property in Table 1080-3.

Page 10-161, Subarticle 1080-9(E) Color Variation, Table 1080-3, replace Test Method “ASTM” with “ASTM E70” for the pH property in Table 1080-3.

Page 10-162, Article 1080-50 PAINT FOR VERTICAL MARKERS, line 1, replace article number “1080-50” with “1080-10”.

Page 10-162, Article 1080-61 EPOXY RESIN FOR REINFORCING STEEL, line 5, replace article number “1080-61” with “1080-11”.

Page 10-162, Article 1080-72 ABRASIVE MATERIALS FOR BLAST CLEANING STEEL, line 22, replace article number “1080-72” with “1080-12”.

Page 10-163, Article 1080-83 FIELD PERFORMANCE AND SERVICES, line 25, replace article number “1080-83” with “1080-13”.

Page 10-166, Subarticle 1081-1(E) Prequalification, line 24, replace “Value Management Unit” with “Product Evaluation Program”.

Page 10-168, Subarticle 1081-3(A) Physical Requirements, after line 25, replace “Subarticle 1081-4(B)” with “Subarticle 1081-3(B)” in Table 1081-2.

Page 10-168, Subarticle 1087-2(A) Paint Composition, lines 19-20, replace “Federal Specification TTP 1952F” with “Federal Specification TT-P-1952”.

Page 10-200, Subarticle 1090-1(C) Anchor Bolts, line 38, replace ASTM number “A325” with “F3125”.

Page 10-202, Subarticle 1091-3(F) Solid Wall HDPE Conduit, line 5, replace “, Table 1091-1, 1091-2 and 1091-3” with “and Table 1091-1”.

Page 10-208, Subarticle 1094-1(A) Breakaway or Simple Steel Beam Sign Supports, line 19, replace ASTM number “A325” with “F3125”.

Page 10-209, Subarticle 1094-1(D) Steel Square Tube Posts, line 10, replace ASTM number “A123” with “A653”.

Page 10-209, Subarticle 1094-1(E) Wood Supports, line 17, replace “Article 1082-2 and 1082-3” with “Section 1082”.

Page 10-212, Subarticle 1098-1(H) Electrical Service, line 21, replace “NEMA Type 3R” with “NEMA 3R”.

Page 10-212, Subarticle 1098-1(H) Electrical Service, line 36, replace “UL Standard 231” with “UL Standard UL-231”.

Page 10-212, Subarticle 1098-1(H) Electrical Service, line 37, replace “UL Standard 67” with “UL Standard UL-67”.

Page 10-224, Subarticle 1098-14(H)(1) Type I – Pedestrian Pushbutton Post, line 3, replace ASTM number “325” with “F3125”.

Page 10-224, Article 1098-16 CABINET BASE ADAPTER/EXTENDER, line 33, replace Section number “6.7” with “6.8”.

Division 14

Page 14-11, Subarticle 1401-2(B) Lowering Device, line 36, replace Military Specification “MIL-W-83420E” with “MIL-DTL-83420”.

Page 14-22, Article 1412-2 MATERIALS, line 29, replace UL Standard “1572” with “1598”.

Division 15

Page 15-6, Subarticle 1510-3(B) Testing and Sterilization, line 40, replace Section number “4.4.3” with “4.4”.

Page 15-14, Article 1525-2 MATERIALS, line 9, replace “AASHTO M 198” with “ASTM C990”.

Page 15-14, Article 1525-2 MATERIALS, lines 17-18, delete “in the Grout Production and Delivery provision”.

Page 15-19, Article 1550-2 MATERIALS, line 16, replace “*AASHTO LRFD Bridge Design Specifications*” with “*AASHTO LRFD Bridge Construction Specifications*”.

Division 16

Page 16-9, Article 1630-3 MEASUREMENT AND PAYMENT, line 7, replace “Section 225” with “Article 225-7”.

Page 16-9, Article 1630-3 MEASUREMENT AND PAYMENT, line 8, replace “Section 230” with “Article 230-5”.

Page 16-16, Article 1637-5 MEASUREMENT AND PAYMENT, line 17, replace "Section 310" with "Article 310-6".

Division 17

Page 17-15, Article 1715-4 MEASUREMENT AND PAYMENT, lines 42-44, replace the second sentence with the following:

An example is an installation of a single 1.25 inch HDPE conduit would be paid as:

Directional Drill (1)(1.25") Linear Foot

Page 17-15, Subarticle 1715-3(E) Bore and Jack, line 5, replace article number "1540-4" with "1550-4".

Page 17-15, Subarticle 1715-3(E) Bore and Jack, lines 10 & 11, replace "*NCDOT Policies and Procedures for Accommodating Utilities on Highway Rights of Way*" with "*NCDOT Utilities Accommodations Manual*".

STANDARD SPECIAL PROVISION**PLANT AND PEST QUARANTINES****(Imported Fire Ant, Gypsy Moth, Witchweed, Emerald Ash Borer, Guava Root Knot Nematode, And Other Noxious Weeds)**

(3-18-03) (Rev. 5-21-19)

Z-04a

Within Quarantined Area

This project may be within a county regulated for plant and/or pests. If the project or any part of the Contractor's operations is located within a quarantined area, thoroughly clean all equipment prior to moving out of the quarantined area. Comply with federal/state regulations by obtaining a certificate or limited permit for any regulated article moving from the quarantined area.

Originating in a Quarantined County

Obtain a certificate or limited permit issued by the N.C. Department of Agriculture/United States Department of Agriculture. Have the certificate or limited permit accompany the article when it arrives at the project site.

Contact

Contact the N.C. Department of Agriculture/United States Department of Agriculture at 1-800-206-9333, 919-707-3730, or <https://www.ncagr.gov/plantindustry/Plant/quaran/table2.htm> to determine those specific project sites located in the quarantined area or for any regulated article used on this project originating in a quarantined county.

Regulated Articles Include

1. Soil, sand, gravel, compost, peat, humus, muck, and decomposed manure, separately or with other articles. This includes movement of articles listed above that may be associated with cut/waste, ditch pulling, and shoulder cutting.
2. Plants with roots including grass sod.
3. Plant crowns and roots.
4. Bulbs, corms, rhizomes, and tubers of ornamental plants.
5. Hay, straw, fodder, and plant litter of any kind.
6. Clearing and grubbing debris.
7. Used agricultural cultivating and harvesting equipment.
8. Used earth-moving equipment.
9. Any other products, articles, or means of conveyance, of any character, if determined by an inspector to present a hazard of spreading imported fire ant, gypsy moth, witchweed, emerald ash borer, guava root knot nematode, or other noxious weeds.

STANDARD SPECIAL PROVISION**TITLE VI AND NONDISCRIMINATION:**

(6-28-77)(Rev 6/19/2018)

Z-6

Revise the *2018 Standard Specifications* as follows:

Replace Article 103-4(B) with the following:

The North Carolina Department of Transportation is committed to carrying out the U.S. Department of Transportation's policy of ensuring nondiscrimination in the award and administration of contracts.

The provisions of this section related to United States Department of Transportation (US DOT) Order 1050.2A, Title 49 Code of Federal Regulations (CFR) part 21, 23 United States Code (U.S.C.) 140 and 23 CFR part 200 (or 49 CFR 303, 49 U.S.C. 5332 or 49 U.S.C. 47123) are applicable to all North Carolina Department of Transportation (NCDOT) contracts and to all related subcontracts, material supply, engineering, architectural and other service contracts, regardless of dollar amount. Any Federal provision that is specifically required not specifically set forth is hereby incorporated by reference.

(1) Title VI Assurances (USDOT Order 1050.2A, Appendix A)

During the performance of this contract, the contractor, for itself, its assignees, and successors in interest (hereinafter referred to as the "contractor") agrees as follows:

(a) Compliance with Regulations

The contractor (hereinafter includes consultants) shall comply with the Acts and the Regulations relative to Nondiscrimination in Federally-assisted programs of the U.S. Department of Transportation, Federal Highway Administration (FHWA), as they may be amended from time to time, which are herein incorporated by reference and made a part of this contract.

(b) Nondiscrimination

The contractor, with regard to the work performed by it during the contract, shall not discriminate on the grounds of race, color, or national origin in the selection and retention of subcontractors, including procurements of materials and leases of equipment. The contractor shall not participate directly or indirectly in the discrimination prohibited by the Acts and the Regulations, including employment practices when the contract covers any activity, project, or program set forth in Appendix B of 49 CFR Part 21.

(c) Solicitations for Subcontractors, Including Procurements of Materials and Equipment

In all solicitations, either by competitive bidding, or negotiation made by the contractor for work to be performed under a subcontract, including procurements of materials, or leases of equipment, each potential subcontractor or supplier shall be notified by the contractor of the contractor's obligations under this contract and the Acts and the Regulations relative to Nondiscrimination on the grounds of race, color, or national origin.

(d) Information and Reports

The contractor shall provide all information and reports required by the Acts, the Regulations, and directives issued pursuant thereto and shall permit access to its books, records, accounts, other sources of information, and its facilities as may be determined by the Recipient or the FHWA to be pertinent to ascertain compliance with such Acts, Regulations, and instructions. Where any information required of a contractor is in the exclusive possession of another who fails or refuses to furnish the information, the contractor shall so certify to the Recipient or the FHWA, as appropriate, and shall set forth what efforts it has made to obtain the information.

(e) Sanctions for Noncompliance:

In the event of a contractor's noncompliance with the Non-discrimination provisions of this contract, the Recipient will impose such contract sanctions as it and/or the FHWA may determine to be appropriate, including, but not limited to:

- (i) Withholding payments to the contractor under the contract until the contractor complies; and/or
 - (ii) Cancelling, terminating, or suspending a contract, in whole or in part.
- (f) Incorporation of Provisions

The contractor shall include the provisions of paragraphs (a) through (f) in every subcontract, including procurements of materials and leases of equipment, unless exempt by the Acts, the Regulations and directives issued pursuant thereto. The contractor shall take action with respect to any subcontract or procurement as the Recipient or the FHWA may direct as a means of enforcing such provisions including sanctions for noncompliance. Provided, that if the contractor becomes involved in, or is threatened with litigation by a subcontractor, or supplier because of such direction, the contractor may request the Recipient to enter into any litigation to protect the interests of the Recipient. In addition, the contractor may request the United States to enter into the litigation to protect the interests of the United States.

(2) Title VI Nondiscrimination Program (23 CFR 200.5(p))

The North Carolina Department of Transportation (NCDOT) has assured the USDOT that, as a condition to receiving federal financial assistance, NCDOT will comply with Title VI of the Civil Rights Act of 1964 and all requirements imposed by Title 49 CFR part 21 and related nondiscrimination authorities to ensure that no person shall, on the ground of race, color, national origin, limited English proficiency, sex, age, or disability (including religion/creed or income-level, where applicable), be excluded from participation in, be denied the benefits of, or be subjected to discrimination under any programs, activities, or services conducted or funded by NCDOT. Contractors and other organizations under contract or agreement with NCDOT must also comply with Title VI and related authorities, therefore:

- (a) During the performance of this contract or agreement, contractors (e.g., subcontractors, consultants, vendors, prime contractors) are responsible for complying with NCDOT's Title VI Program. Contractors are not required to prepare or submit Title VI Programs. To comply with this section, the prime contractor shall:
 1. Post NCDOT's Notice of Nondiscrimination and the Contractor's own Equal Employment Opportunity (EEO) Policy in conspicuous locations accessible to all employees, applicants and subcontractors on the jobsite.
 2. Physically incorporate the required Title VI clauses into all subcontracts on federally-assisted and state-funded NCDOT projects, and ensure inclusion by subcontractors into all lower-tier subcontracts.
 3. Required Solicitation Language. The Contractor shall include the following notification in all solicitations for bids and requests for work or material, regardless of funding source:

“The North Carolina Department of Transportation, in accordance with the provisions of Title VI of the Civil Rights Act of 1964 (78 Stat. 252, 42 U.S.C. §§ 2000d to 2000d-4) and the Regulations, hereby notifies all bidders that it will affirmatively ensure that any contract entered into pursuant to this advertisement, disadvantaged business enterprises will be afforded full and fair opportunity to submit bids in response to this invitation and will not be discriminated against on the grounds of race, color, or national origin in consideration for an award. In accordance with other related nondiscrimination authorities, bidders and contractors will also not be discriminated against on the grounds of sex, age, disability, low-income level, creed/religion, or limited English proficiency in consideration for an award.”

4. Physically incorporate the FHWA-1273, in its entirety, into all subcontracts and subsequent lower tier subcontracts on Federal-aid highway construction contracts only.
 5. Provide language assistance services (i.e., written translation and oral interpretation), free of charge, to LEP employees and applicants. Contact NCDOT OCR for further assistance, if needed.
 6. For assistance with these Title VI requirements, contact the NCDOT Title VI Nondiscrimination Program at 1-800-522-0453.
- (b) Subrecipients (e.g. cities, counties, LGAs, planning organizations) may be required to prepare and submit a Title VI Plan to NCDOT, including Title VI Assurances and/or agreements. Subrecipients must also ensure compliance by their contractors and subrecipients with Title VI. (23 CFR 200.9(b)(7))
- (c) If reviewed or investigated by NCDOT, the contractor or subrecipient agrees to take affirmative action to correct any deficiencies found within a reasonable time period, not to exceed 90 calendar days, unless additional time is granted by NCDOT. (23 CFR 200.9(b)(15))
- (d) The Contractor is responsible for notifying subcontractors of NCDOT's External Discrimination Complaints Process.
1. **Applicability**
Title VI and related laws protect participants and beneficiaries (e.g., members of the public and contractors) from discrimination by NCDOT employees, subrecipients and contractors, regardless of funding source.
 2. **Eligibility**
Any person—or class of persons—who believes he/she has been subjected to discrimination based on race, color, national origin, Limited English Proficiency (LEP), sex, age, or disability (and religion in the context of employment, aviation, or transit) may file a written complaint. The law also prohibits intimidation or retaliation of any sort.
 3. **Time Limits and Filing Options**
Complaints may be filed by the affected individual(s) or a representative and must be filed no later than 180 calendar days after the following:
 - (i) The date of the alleged act of discrimination; or
 - (ii) The date when the person(s) became aware of the alleged discrimination; or
 - (iii) Where there has been a continuing course of conduct, the date on which that conduct was discontinued or the latest instance of the conduct.Title VI and related discrimination complaints may be submitted to the following entities:
 - North Carolina Department of Transportation, Office of Civil Rights, Title VI Program, 1511 Mail Service Center, Raleigh, NC 27699-1511; toll free 1-800-522-0453
 - Federal Highway Administration, North Carolina Division Office, 310 New Bern Avenue, Suite 410, Raleigh, NC 27601, 919-747-7010
 - US Department of Transportation, Departmental Office of Civil Rights, External Civil Rights Programs Division, 1200 New Jersey Avenue, SE, Washington, DC 20590; 202-366-4070
 4. **Format for Complaints**
Complaints must be in writing and signed by the complainant(s) or a representative, and include the complainant's name, address, and telephone number. Complaints received by fax or e-mail will be acknowledged and processed. Allegations received by telephone will be reduced to writing and provided to the complainant for confirmation or revision before processing. Complaints will be accepted in other languages, including Braille.
 5. **Discrimination Complaint Form**
Contact NCDOT Civil Rights to receive a full copy of the Discrimination Complaint Form and procedures.

6. Complaint Basis

Allegations must be based on issues involving race, color, national origin (LEP), sex, age, disability, or religion (in the context of employment, aviation or transit). “Basis” refers to the complainant’s membership in a protected group category.

**TABLE 103-1
COMPLAINT BASIS**

Protected Categories	Definition	Examples	Applicable Nondiscrimination Authorities
Race and Ethnicity	An individual belonging to one of the accepted racial groups; or the perception, based usually on physical characteristics that a person is a member of a racial group	Black/African American, Hispanic/Latino, Asian, American Indian/Alaska Native, Native Hawaiian/Pacific Islander, White	Title VI of the Civil Rights Act of 1964; 49 CFR Part 21; 23 CFR 200; 49 U.S.C. 5332(b); 49 U.S.C. 47123. (<i>Executive Order 13166</i>)
Color	Color of skin, including shade of skin within a racial group	Black, White, brown, yellow, etc.	
National Origin (<i>Limited English Proficiency</i>)	Place of birth. Citizenship is not a factor. (<i>Discrimination based on language or a person’s accent is also covered</i>)	Mexican, Cuban, Japanese, Vietnamese, Chinese	
Sex	Gender. The sex of an individual. <i>Note: Sex under this program does not include sexual orientation.</i>	Women and Men	1973 Federal-Aid Highway Act; 49 U.S.C. 5332(b); 49 U.S.C. 47123.
Age	Persons of any age	21-year-old person	Age Discrimination Act of 1975 49 U.S.C. 5332(b); 49 U.S.C. 47123.
Disability	Physical or mental impairment, permanent or temporary, or perceived.	Blind, alcoholic, para-amputee, epileptic, diabetic, arthritic	Section 504 of the Rehabilitation Act of 1973; Americans with Disabilities Act of 1990
Religion (in the context of employment) (<i>Religion/ Creed in all aspects of any aviation or transit-related construction</i>)	An individual belonging to a religious group; or the perception, based on distinguishable characteristics that a person is a member of a religious group. In practice, actions taken as a result of the moral and ethical beliefs as to what is right and wrong, which are sincerely held with the strength of traditional religious views. <i>Note: Does not have to be associated with a recognized religious group or church; if an individual sincerely holds to the belief, it is a protected religious practice.</i>	Muslim, Christian, Sikh, Hindu, etc.	Title VII of the Civil Rights Act of 1964; 23 CFR 230; FHWA-1273 Required Contract Provisions. (<i>49 U.S.C. 5332(b); 49 U.S.C. 47123</i>)

(3) Pertinent Nondiscrimination Authorities

During the performance of this contract, the contractor, for itself, its assignees, and successors in interest agrees to comply with the following non-discrimination statutes and authorities, including, but not limited to:

- (a) Title VI of the Civil Rights Act of 1964 (42 U.S.C. § 2000d et seq., 78 stat. 252), (prohibits discrimination on the basis of race, color, national origin); and 49 CFR Part 21.
 - (b) The Uniform Relocation Assistance and Real Property Acquisition Policies Act of 1970, (42 U.S.C. § 4601), (prohibits unfair treatment of persons displaced or whose property has been acquired because of Federal or Federal-aid programs and projects);
 - (c) Federal-Aid Highway Act of 1973, (23 U.S.C. § 324 et seq.), (prohibits discrimination on the basis of sex);
 - (d) Section 504 of the Rehabilitation Act of 1973, (29 U.S.C. § 794 et seq.), as amended, (prohibits discrimination on the basis of disability) and 49 CFR Part 27;
 - (e) The Age Discrimination Act of 1975, as amended, (42 U.S.C. § 6101 et seq.), (prohibits discrimination on the basis of age);
 - (f) Airport and Airway Improvement Act of 1982, (49 USC § 471, Section 47123), as amended, (prohibits discrimination based on race, creed, color, national origin, or sex);
 - (g) The Civil Rights Restoration Act of 1987, (PL 100-209), (Broadened the scope, coverage and applicability of Title VI of the Civil Rights Act of 1964, The Age Discrimination Act of 1975 and Section 504 of the Rehabilitation Act of 1973, by expanding the definition of the terms "programs or activities" to include all of the programs or activities of the Federal-aid recipients, sub-recipients and contractors, whether such programs or activities are Federally funded or not);
 - (h) Titles II and III of the Americans with Disabilities Act, which prohibit discrimination on the basis of disability in the operation of public entities, public and private transportation systems, places of public accommodation, and certain testing entities (42 U.S.C. §§ 12131-12189) as implemented by Department of Transportation regulations at 49 C.F.R. parts 37 and 38;
 - (i) The Federal Aviation Administration's Nondiscrimination statute (49 U.S.C. § 47123) (prohibits discrimination on the basis of race, color, national origin, and sex);
 - (j) Executive Order 12898, Federal Actions to Address Environmental Justice in Minority Populations and Low-Income Populations, which ensures Nondiscrimination against minority populations by discouraging programs, policies, and activities with disproportionately high and adverse human health or environmental effects on minority and low-income populations;
 - (k) Executive Order 13166, Improving Access to Services for Persons with Limited English Proficiency, and resulting agency guidance, national origin discrimination includes discrimination because of Limited English proficiency (LEP). To ensure compliance with Title VI, you must take reasonable steps to ensure that LEP persons have meaningful access to your programs (70 Fed. Reg. at 74087 to 74100);
 - (l) Title IX of the Education Amendments of 1972, as amended, which prohibits you from discriminating because of sex in education programs or activities (20 U.S.C. 1681 et seq).
 - (m) Title VII of the Civil Rights Act of 1964 (42 U.S.C. § 2000e et seq., Pub. L. 88-352), (prohibits employment discrimination on the basis of race, color, religion, sex, or national origin).
- (4) Additional Title VI Assurances**
- **The following Title VI Assurances (Appendices B, C and D) shall apply, as applicable*
- (a) Clauses for Deeds Transferring United States Property (1050.2A, Appendix B)
The following clauses will be included in deeds effecting or recording the transfer of real property, structures, or improvements thereon, or granting interest therein from the United States pursuant to the provisions of Assurance 4.

NOW, THEREFORE, the U.S. Department of Transportation as authorized by law and upon the condition that the North Carolina Department of Transportation (NCDOT) will accept title to the lands and maintain the project constructed thereon in accordance with the North Carolina General Assembly, the Regulations for the Administration of the Federal-Aid Highway Program, and the policies and procedures prescribed by the Federal Highway Administration of the U.S. Department of Transportation in accordance and in compliance with all requirements imposed by Title 49, Code of Federal Regulations, U.S. Department of Transportation, Subtitle A, Office of the Secretary, Part 21, Nondiscrimination in Federally-assisted programs of the U.S. Department of Transportation pertaining to and effectuating the provisions of Title VI of the Civil Rights Act of 1964 (78 Stat. 252; 42 U.S.C. § 2000d to 2000d-4), does hereby remise, release, quitclaim and convey unto the NCDOT all the right, title and interest of the U.S. Department of Transportation in and to said lands described in Exhibit A attached hereto and made a part hereof.

(HABENDUM CLAUSE)

TO HAVE AND TO HOLD said lands and interests therein unto the North Carolina Department of Transportation (NCDOT) and its successors forever, subject, however, to the covenants, conditions, restrictions and reservations herein contained as follows, which will remain in effect for the period during which the real property or structures are used for a purpose for which Federal financial assistance is extended or for another purpose involving the provision of similar services or benefits and will be binding on the NCDOT, its successors and assigns.

The NCDOT, in consideration of the conveyance of said lands and interests in lands, does hereby covenant and agree as a covenant running with the land for itself, its successors and assigns, that (1) no person will on the grounds of race, color, or national origin, be excluded from participation in, be denied the benefits of, or be otherwise subjected to discrimination with regard to any facility located wholly or in part on, over, or under such lands hereby conveyed [,] [and]* (2) that the NCDOT will use the lands and interests in lands and interests in lands so conveyed, in compliance with all requirements imposed by or pursuant to Title 49, Code of Federal Regulations, U.S. Department of Transportation, Subtitle A, Office of the Secretary, Part 21, Non-discrimination in Federally-assisted programs of the U.S. Department of Transportation, Effectuation of Title VI of the Civil Rights Act of 1964, and as said Regulations and Acts may be amended [, and (3) that in the event of breach of any of the above-mentioned nondiscrimination conditions, the Department will have a right to enter or re-enter said lands and facilities on said land, and that above described land and facilities will thereon revert to and vest in and become the absolute property of the U.S. Department of Transportation and its assigns as such interest existed prior to this instruction].*

(*Reverter clause and related language to be used only when it is determined that such a clause is necessary in order to make clear the purpose of Title VI.)

- (b) Clauses for Transfer of Real Property Acquired or Improved Under the Activity, Facility, or Program (1050.2A, Appendix C)

The following clauses will be included in deeds, licenses, leases, permits, or similar instruments entered into by the North Carolina Department of Transportation (NCDOT) pursuant to the provisions of Assurance 7(a):

1. The (grantee, lessee, permittee, etc. as appropriate) for himself/herself, his/her heirs, personal representatives, successors in interest, and assigns, as a part of the consideration hereof, does hereby covenant and agree [in the case of deeds and leases add "as a covenant running with the land"] that:

- (i.) In the event facilities are constructed, maintained, or otherwise operated on the property described in this (deed, license, lease, permit, etc.) for a purpose for which a U.S. Department of Transportation activity, facility, or program is extended or for another purpose involving the provision of similar services or benefits, the (grantee, licensee, lessee, permittee, etc.) will maintain and operate such facilities and services in compliance with all requirements imposed by the Acts and Regulations (as may be amended) such that no person on the grounds of race, color, or national origin, will be excluded from participation in, denied the benefits of, or be otherwise subjected to discrimination in the use of said facilities.
 2. With respect to licenses, leases, permits, etc., in the event of breach of any of the above Nondiscrimination covenants, the NCDOT will have the right to terminate the (lease, license, permit, etc.) and to enter, re-enter, and repossess said lands and facilities thereon, and hold the same as if the (lease, license, permit, etc.) had never been made or issued. *
 3. With respect to a deed, in the event of breach of any of the above Nondiscrimination covenants, the NCDOT will have the right to enter or re-enter the lands and facilities thereon, and the above described lands and facilities will there upon revert to and vest in and become the absolute property of the NCDOT and its assigns. *
- (*Reverter clause and related language to be used only when it is determined that such a clause is necessary to make clear the purpose of Title VI.)
- (c) Clauses for Construction/Use/Access to Real Property Acquired Under the Activity, Facility or Program (1050.2A, Appendix D)
- The following clauses will be included in deeds, licenses, permits, or similar instruments/agreements entered into by the North Carolina Department of Transportation (NCDOT) pursuant to the provisions of Assurance 7(b):
1. The (grantee, licensee, permittee, etc., as appropriate) for himself/herself, his/her heirs, personal representatives, successors in interest, and assigns, as a part of the consideration hereof, does hereby covenant and agree (in the case of deeds and leases add, "as a covenant running with the land") that (1) no person on the ground of race, color, or national origin, will be excluded from participation in, denied the benefits of, or be otherwise subjected to discrimination in the use of said facilities, (2) that in the construction of any improvements on, over, or under such land, and the furnishing of services thereon, no person on the ground of race, color, or national origin, will be excluded from participation in, denied the benefits of, or otherwise be subjected to discrimination, (3) that the (grantee, licensee, lessee, permittee, etc.) will use the premises in compliance with all other requirements imposed by or pursuant to the Acts and Regulations, as amended, set forth in this Assurance.
 2. With respect to (licenses, leases, permits, etc.), in the event of breach of any of the above Non-discrimination covenants, the NCDOT will have the right to terminate the (license, permit, etc., as appropriate) and to enter or re-enter and repossess said land and the facilities thereon, and hold the same as if said (license, permit, etc., as appropriate) had never been made or issued. *
 3. With respect to deeds, in the event of breach of any of the above Nondiscrimination covenants, the NCDOT will there upon revert to and vest in and become the absolute property of the NCDOT and its assigns. *
- (*Reverter clause and related language to be used only when it is determined that such a clause is necessary to make clear the purpose of Title VI.)

STANDARD SPECIAL PROVISION**MINORITY AND FEMALE EMPLOYMENT REQUIREMENTS**

Z-7

NOTICE OF REQUIREMENTS FOR AFFIRMATIVE ACTION TO ENSURE EQUAL EMPLOYMENT OPPORTUNITY (*EXECUTIVE NUMBER 11246*)

1. The goals and timetables for minority and female participation, expressed in percentage terms for the Contractor's aggregate workforce in each trade on all construction work in the covered area, see as shown on the attached sheet entitled "Employment Goals for Minority and Female participation".

These goals are applicable to all the Contractor's construction work (whether or not it is Federal or federally assisted) performed in the covered area. If the Contractor performs construction work in a geographical area located outside of the covered area, it shall apply the goals established for such geographical area where the work is actually performed. With regard to this second area, the Contractor also is subject to the goals for both its federally involved and nonfederally involved construction.

The Contractor's compliance with the Executive Order and the regulations in *41 CFR Part 60-4* shall be based on its implementation of the Equal Opportunity Clause, specific affirmative action obligations required by the specifications set forth in *41 CFR 60-4.3(a)*, and its effort to meet the goals. The hours of minority and female employment and training must be substantially uniform throughout the length of the contract, and in each trade and the Contractor shall make a good faith effort to employ minorities and women evenly on each of its projects. The transfer of minority or female employees or trainees from Contractor to Contractor or from project to project for the sole purpose of meeting the Contractor's goals shall be a violation of the contract, the executive Order and the regulations in *41 CFR Part 60-4*. Compliance with the goals will be measured against the total work hours performed.

2. As used in this Notice and in the contract resulting from this solicitation, the "covered area" is the county or counties shown on the cover sheet of the proposal form and contract.

**EMPLOYMENT GOALS FOR MINORITY
AND FEMALE PARTICIPATION**

Economic Areas

Area 023 29.7%

Bertie County
Camden County
Chowan County
Gates County
Hertford County
Pasquotank County
Perquimans County

Area 024 31.7%

Beaufort County
Carteret County
Craven County
Dare County
Edgecombe County
Green County
Halifax County
Hyde County
Jones County
Lenoir County
Martin County
Nash County
Northampton County
Pamlico County
Pitt County
Tyrrell County
Washington County
Wayne County
Wilson County

Area 025 23.5%

Columbus County
Duplin County
Onslow County
Pender County

Area 026 33.5%

Bladen County
Hoke County
Richmond County
Robeson County
Sampson County
Scotland County

Area 027 24.7%

Chatham County
Franklin County
Granville County
Harnett County
Johnston County
Lee County
Person County
Vance County
Warren County

Area 028 15.5%

Alleghany County
Ashe County
Caswell County
Davie County
Montgomery County
Moore County
Rockingham County
Surry County
Watauga County
Wilkes County

Area 029 15.7%

Alexander County
Anson County
Burke County
Cabarrus County
Caldwell County
Catawba County
Cleveland County
Iredell County
Lincoln County
Polk County
Rowan County
Rutherford County
Stanly County

Area 0480 8.5%

Buncombe County
Madison County

Area 030 6.3%

Avery County
Cherokee County
Clay County
Graham County
Haywood County
Henderson County
Jackson County
McDowell County
Macon County
Mitchell County
Swain County
Transylvania County
Yancey County

SMSA Areas

Area 5720 26.6%

Currituck County

Area 9200 20.7%

Brunswick County

New Hanover County

Area 2560 24.2%

Cumberland County

Area 6640 22.8%

Durham County

Orange County

Wake County

Area 1300 16.2%

Alamance County

Area 3120 16.4%

Davidson County

Forsyth County

Guilford County

Randolph County

Stokes County

Yadkin County

Area 1520 18.3%

Gaston County

Mecklenburg County

Union County

Goals for Female

Participation in Each Trade

(Statewide) 6.9%

REQUIRED CONTRACT PROVISIONS FEDERAL-AID CONSTRUCTION CONTRACTS

- I. General
- II. Nondiscrimination
- III. Non-segregated Facilities
- IV. Davis-Bacon and Related Act Provisions
- V. Contract Work Hours and Safety Standards Act Provisions
- VI. Subletting or Assigning the Contract
- VII. Safety: Accident Prevention
- VIII. False Statements Concerning Highway Projects
- IX. Implementation of Clean Air Act and Federal Water Pollution Control Act
- X. Certification Regarding Debarment, Suspension, Ineligibility and Voluntary Exclusion
- XI. Certification Regarding Use of Contract Funds for Lobbying
- XII. Use of United States-Flag Vessels:

ATTACHMENTS

A. Employment and Materials Preference for Appalachian Development Highway System or Appalachian Local Access Road Contracts (included in Appalachian contracts only)

I. GENERAL

1. Form FHWA-1273 must be physically incorporated in each construction contract funded under title 23, United States Code, as required in 23 CFR 633.102(b) (excluding emergency contracts solely intended for debris removal). The contractor (or subcontractor) must insert this form in each subcontract and further require its inclusion in all lower tier subcontracts (excluding purchase orders, rental agreements and other agreements for supplies or services). 23 CFR 633.102(e).

The applicable requirements of Form FHWA-1273 are incorporated by reference for work done under any purchase order, rental agreement or agreement for other services. The prime contractor shall be responsible for compliance by any subcontractor, lower-tier subcontractor or service provider. 23 CFR 633.102(e).

Form FHWA-1273 must be included in all Federal-aid design-build contracts, in all subcontracts and in lower tier subcontracts (excluding subcontracts for design services, purchase orders, rental agreements and other agreements for supplies or services) in accordance with 23 CFR 633.102. The design-builder shall be responsible for compliance by any subcontractor, lower-tier subcontractor or service provider.

Contracting agencies may reference Form FHWA-1273 in solicitation-for-bids or request-for-proposals documents, however, the Form FHWA-1273 must be physically incorporated (not referenced) in all contracts, subcontracts and lower-tier subcontracts (excluding purchase orders, rental agreements and other agreements for supplies or services related to a construction contract). 23 CFR 633.102(b).

2. Subject to the applicability criteria noted in the following sections, these contract provisions shall apply to all work

performed on the contract by the contractor's own organization and with the assistance of workers under the contractor's immediate superintendence and to all work performed on the contract by piecework, station work, or by subcontract. 23 CFR 633.102(d).

3. A breach of any of the stipulations contained in these Required Contract Provisions may be sufficient grounds for withholding of progress payments, withholding of final payment, termination of the contract, suspension / debarment or any other action determined to be appropriate by the contracting agency and FHWA.
4. Selection of Labor: During the performance of this contract, the contractor shall not use convict labor for any purpose within the limits of a construction project on a Federal-aid highway unless it is labor performed by convicts who are on parole, supervised release, or probation. 23 U.S.C. 114(b). The term Federal-aid highway does not include roadways functionally classified as local roads or rural minor collectors. 23 U.S.C. 101(a).

II. NONDISCRIMINATION (23 CFR 230.107(a); 23 CFR Part 230, Subpart A, Appendix A; EO 11246)

The provisions of this section related to 23 CFR Part 230, Subpart A, Appendix A are applicable to all Federal-aid construction contracts and to all related construction subcontracts of \$10,000 or more. The provisions of 23 CFR Part 230 are not applicable to material supply, engineering, or architectural service contracts.

In addition, the contractor and all subcontractors must comply with the following policies: Executive Order 11246, 41 CFR Part 60, 29 CFR Parts 1625-1627, 23 U.S.C. 140, Section 504 of the Rehabilitation Act of 1973, as amended (29 U.S.C. 794), Title VI of the Civil Rights Act of 1964, as amended (42 U.S.C. 2000d et seq.), and related regulations including 49 CFR Parts 21, 26, and 27; and 23 CFR Parts 200, 230, and 633.

The contractor and all subcontractors must comply with: the requirements of the Equal Opportunity Clause in 41 CFR 60-1.4(b) and, for all construction contracts exceeding \$10,000, the Standard Federal Equal Employment Opportunity Construction Contract Specifications in 41 CFR 60-4.3.

Note: The U.S. Department of Labor has exclusive authority to determine compliance with Executive Order 11246 and the policies of the Secretary of Labor including 41 CFR Part 60, and 29 CFR Parts 1625-1627. The contracting agency and the FHWA have the authority and the responsibility to ensure compliance with 23 U.S.C. 140, Section 504 of the Rehabilitation Act of 1973, as amended (29 U.S.C. 794), and Title VI of the Civil Rights Act of 1964, as amended (42 U.S.C. 2000d et seq.), and related regulations including 49 CFR Parts 21, 26, and 27; and 23 CFR Parts 200, 230, and 633.

The following provision is adopted from 23 CFR Part 230, Subpart A, Appendix A, with appropriate revisions to conform to the U.S. Department of Labor (US DOL) and FHWA requirements.

- 1. Equal Employment Opportunity:** Equal Employment Opportunity (EEO) requirements not to discriminate and to take affirmative action to assure equal opportunity as set forth under laws, executive orders, rules, regulations (*see* 28 CFR Part 35, 29 CFR Part 1630, 29 CFR Parts 1625-1627, 41 CFR Part 60 and 49 CFR Part 27) and orders of the Secretary of Labor as modified by the provisions prescribed herein, and imposed pursuant to 23 U.S.C. 140, shall constitute the EEO and specific affirmative action standards for the contractor's project activities under this contract. The provisions of the Americans with Disabilities Act of 1990 (42 U.S.C. 12101 et seq.) set forth under 28 CFR Part 35 and 29 CFR Part 1630 are incorporated by reference in this contract. In the execution of this contract, the contractor agrees to comply with the following minimum specific requirement activities of EEO:
- The contractor will work with the contracting agency and the Federal Government to ensure that it has made every good faith effort to provide equal opportunity with respect to all of its terms and conditions of employment and in their review of activities under the contract. 23 CFR 230.409 (g)(4) & (5).
 - The contractor will accept as its operating policy the following statement:

"It is the policy of this Company to assure that applicants are employed, and that employees are treated during employment, without regard to their race, religion, sex, sexual orientation, gender identity, color, national origin, age or disability. Such action shall include: employment, upgrading, demotion, or transfer; recruitment or recruitment advertising; layoff or termination; rates of pay or other forms of compensation; and selection for training, including apprenticeship, pre-apprenticeship, and/or on-the-job training."
- 2. EEO Officer:** The contractor will designate and make known to the contracting officers an EEO Officer who will have the responsibility for and must be capable of effectively administering and promoting an active EEO program and who must be assigned adequate authority and responsibility to do so.
- 3. Dissemination of Policy:** All members of the contractor's staff who are authorized to hire, supervise, promote, and discharge employees, or who recommend such action or are substantially involved in such action, will be made fully cognizant of and will implement the contractor's EEO policy and contractual responsibilities to provide EEO in each grade and classification of employment. To ensure that the above agreement will be met, the following actions will be taken as a minimum:
- Periodic meetings of supervisory and personnel office employees will be conducted before the start of work and then not less often than once every six months, at which time the contractor's EEO policy and its implementation will be reviewed and explained. The meetings will be conducted by the EEO Officer or other knowledgeable company official.
 - All new supervisory or personnel office employees will be given a thorough indoctrination by the EEO Officer, covering all major aspects of the contractor's EEO obligations within thirty days following their reporting for duty with the contractor.
 - All personnel who are engaged in direct recruitment for the project will be instructed by the EEO Officer in the contractor's procedures for locating and hiring minorities and women.
- Notices and posters setting forth the contractor's EEO policy will be placed in areas readily accessible to employees, applicants for employment and potential employees.
 - The contractor's EEO policy and the procedures to implement such policy will be brought to the attention of employees by means of meetings, employee handbooks, or other appropriate means.
- 4. Recruitment:** When advertising for employees, the contractor will include in all advertisements for employees the notation: "An Equal Opportunity Employer." All such advertisements will be placed in publications having a large circulation among minorities and women in the area from which the project work force would normally be derived.
- The contractor will, unless precluded by a valid bargaining agreement, conduct systematic and direct recruitment through public and private employee referral sources likely to yield qualified minorities and women. To meet this requirement, the contractor will identify sources of potential minority group employees and establish with such identified sources procedures whereby minority and women applicants may be referred to the contractor for employment consideration.
 - In the event the contractor has a valid bargaining agreement providing for exclusive hiring hall referrals, the contractor is expected to observe the provisions of that agreement to the extent that the system meets the contractor's compliance with EEO contract provisions. Where implementation of such an agreement has the effect of discriminating against minorities or women, or obligates the contractor to do the same, such implementation violates Federal nondiscrimination provisions.
 - The contractor will encourage its present employees to refer minorities and women as applicants for employment. Information and procedures with regard to referring such applicants will be discussed with employees.
- 5. Personnel Actions:** Wages, working conditions, and employee benefits shall be established and administered, and personnel actions of every type, including hiring, upgrading, promotion, transfer, demotion, layoff, and termination, shall be taken without regard to race, color, religion, sex, sexual orientation, gender identity, national origin, age or disability. The following procedures shall be followed:
- The contractor will conduct periodic inspections of project sites to ensure that working conditions and employee facilities do not indicate discriminatory treatment of project site personnel.
 - The contractor will periodically evaluate the spread of wages paid within each classification to determine any evidence of discriminatory wage practices.
 - The contractor will periodically review selected personnel actions in depth to determine whether there is evidence of discrimination. Where evidence is found, the contractor will promptly take corrective action. If the review indicates that the discrimination may extend beyond the actions reviewed, such corrective action shall include all affected persons.
 - The contractor will promptly investigate all complaints of alleged discrimination made to the contractor in connection with its obligations under this contract, will attempt to resolve such complaints, and will take appropriate corrective action

within a reasonable time. If the investigation indicates that the discrimination may affect persons other than the complainant, such corrective action shall include such other persons. Upon completion of each investigation, the contractor will inform every complainant of all of their avenues of appeal.

6. Training and Promotion:

a. The contractor will assist in locating, qualifying, and increasing the skills of minorities and women who are applicants for employment or current employees. Such efforts should be aimed at developing full journey level status employees in the type of trade or job classification involved.

b. Consistent with the contractor's work force requirements and as permissible under Federal and State regulations, the contractor shall make full use of training programs (i.e., apprenticeship and on-the-job training programs for the geographical area of contract performance). In the event a special provision for training is provided under this contract, this subparagraph will be superseded as indicated in the special provision. The contracting agency may reserve training positions for persons who receive welfare assistance in accordance with 23 U.S.C. 140(a).

c. The contractor will advise employees and applicants for employment of available training programs and entrance requirements for each.

d. The contractor will periodically review the training and promotion potential of employees who are minorities and women and will encourage eligible employees to apply for such training and promotion.

7. Unions: If the contractor relies in whole or in part upon unions as a source of employees, the contractor will use good faith efforts to obtain the cooperation of such unions to increase opportunities for minorities and women. 23 CFR 230.409. Actions by the contractor, either directly or through a contractor's association acting as agent, will include the procedures set forth below:

a. The contractor will use good faith efforts to develop, in cooperation with the unions, joint training programs aimed toward qualifying more minorities and women for membership in the unions and increasing the skills of minorities and women so that they may qualify for higher paying employment.

b. The contractor will use good faith efforts to incorporate an EEO clause into each union agreement to the end that such union will be contractually bound to refer applicants without regard to their race, color, religion, sex, sexual orientation, gender identity, national origin, age, or disability.

c. The contractor is to obtain information as to the referral practices and policies of the labor union except that to the extent such information is within the exclusive possession of the labor union and such labor union refuses to furnish such information to the contractor, the contractor shall so certify to the contracting agency and shall set forth what efforts have been made to obtain such information.

d. In the event the union is unable to provide the contractor with a reasonable flow of referrals within the time limit set forth in the collective bargaining agreement, the contractor will, through independent recruitment efforts, fill the employment vacancies without regard to race, color, religion, sex, sexual orientation, gender identity, national origin, age, or disability; making full efforts to obtain qualified and/or qualifiable minorities and women. The failure of a union to provide

sufficient referrals (even though it is obligated to provide exclusive referrals under the terms of a collective bargaining agreement) does not relieve the contractor from the requirements of this paragraph. In the event the union referral practice prevents the contractor from meeting the obligations pursuant to Executive Order 11246, as amended, and these special provisions, such contractor shall immediately notify the contracting agency.

8. Reasonable Accommodation for Applicants / Employees with Disabilities: The contractor must be familiar with the requirements for and comply with the Americans with Disabilities Act and all rules and regulations established thereunder. Employers must provide reasonable accommodation in all employment activities unless to do so would cause an undue hardship.

9. Selection of Subcontractors, Procurement of Materials and Leasing of Equipment: The contractor shall not discriminate on the grounds of race, color, religion, sex, sexual orientation, gender identity, national origin, age, or disability in the selection and retention of subcontractors, including procurement of materials and leases of equipment. The contractor shall take all necessary and reasonable steps to ensure nondiscrimination in the administration of this contract.

a. The contractor shall notify all potential subcontractors, suppliers, and lessors of their EEO obligations under this contract.

b. The contractor will use good faith efforts to ensure subcontractor compliance with their EEO obligations.

10. Assurances Required:

a. The requirements of 49 CFR Part 26 and the State DOT's FHWA-approved Disadvantaged Business Enterprise (DBE) program are incorporated by reference.

b. The contractor, subrecipient or subcontractor shall not discriminate on the basis of race, color, national origin, or sex in the performance of this contract. The contractor shall carry out applicable requirements of 49 CFR part 26 in the award and administration of DOT-assisted contracts. Failure by the contractor to carry out these requirements is a material breach of this contract, which may result in the termination of this contract or such other remedy as the recipient deems appropriate, which may include, but is not limited to:

- (1) Withholding monthly progress payments;
- (2) Assessing sanctions;
- (3) Liquidated damages; and/or
- (4) Disqualifying the contractor from future bidding as non-responsible.

c. The Title VI and nondiscrimination provisions of U.S. DOT Order 1050.2A at Appendixes A and E are incorporated by reference. 49 CFR Part 21.

11. Records and Reports: The contractor shall keep such records as necessary to document compliance with the EEO requirements. Such records shall be retained for a period of three years following the date of the final payment to the contractor for all contract work and shall be available at reasonable times and places for inspection by authorized representatives of the contracting agency and the FHWA.

a. The records kept by the contractor shall document the following:

(1) The number and work hours of minority and non-minority group members and women employed in each work classification on the project;

(2) The progress and efforts being made in cooperation with unions, when applicable, to increase employment opportunities for minorities and women; and

(3) The progress and efforts being made in locating, hiring, training, qualifying, and upgrading minorities and women.

a. The contractors and subcontractors will submit an annual report to the contracting agency each July for the duration of the project indicating the number of minority, women, and non-minority group employees currently engaged in each work classification required by the contract work. This information is to be reported on [Form FHWA-1391](#). The staffing data should represent the project work force on board in all or any part of the last payroll period preceding the end of July. If on-the-job training is being required by special provision, the contractor will be required to collect and report training data. The employment data should reflect the work force on board during all or any part of the last payroll period preceding the end of July.

III. NONSEGREGATED FACILITIES

This provision is applicable to all Federal-aid construction contracts and to all related construction subcontracts of more than \$10,000. 41 CFR 60-1.5.

As prescribed by 41 CFR 60-1.8, the contractor must ensure that facilities provided for employees are provided in such a manner that segregation on the basis of race, color, religion, sex, sexual orientation, gender identity, or national origin cannot result. The contractor may neither require such segregated use by written or oral policies nor tolerate such use by employee custom. The contractor's obligation extends further to ensure that its employees are not assigned to perform their services at any location under the contractor's control where the facilities are segregated. The term "facilities" includes waiting rooms, work areas, restaurants and other eating areas, time clocks, restrooms, washrooms, locker rooms and other storage or dressing areas, parking lots, drinking fountains, recreation or entertainment areas, transportation, and housing provided for employees. The contractor shall provide separate or single-user restrooms and necessary dressing or sleeping areas to assure privacy between sexes.

IV. DAVIS-BACON AND RELATED ACT PROVISIONS

This section is applicable to all Federal-aid construction projects exceeding \$2,000 and to all related subcontracts and lower-tier subcontracts (regardless of subcontract size), in accordance with 29 CFR 5.5. The requirements apply to all projects located within the right-of-way of a roadway that is functionally classified as Federal-aid highway. 23 U.S.C. 113. This excludes roadways functionally classified as local roads or rural minor collectors, which are exempt. 23 U.S.C. 101. Where applicable law requires that projects be treated as a project on a Federal-aid highway, the provisions of this subpart will apply regardless of the location of the project. Examples include: Surface Transportation Block Grant Program projects funded under 23 U.S.C. 133 [excluding recreational trails projects], the Nationally Significant Freight and Highway

Projects funded under 23 U.S.C. 117, and National Highway Freight Program projects funded under 23 U.S.C. 167.

The following provisions are from the U.S. Department of Labor regulations in 29 CFR 5.5 "Contract provisions and related matters" with minor revisions to conform to the FHWA-1273 format and FHWA program requirements.

1. Minimum wages (29 CFR 5.5)

a. All laborers and mechanics employed or working upon the site of the work, will be paid unconditionally and not less often than once a week, and without subsequent deduction or rebate on any account (except such payroll deductions as are permitted by regulations issued by the Secretary of Labor under the Copeland Act (29 CFR part 3)), the full amount of wages and bona fide fringe benefits (or cash equivalents thereof) due at time of payment computed at rates not less than those contained in the wage determination of the Secretary of Labor which is attached hereto and made a part hereof, regardless of any contractual relationship which may be alleged to exist between the contractor and such laborers and mechanics.

Contributions made or costs reasonably anticipated for bona fide fringe benefits under section 1(b)(2) of the Davis-Bacon Act on behalf of laborers or mechanics are considered wages paid to such laborers or mechanics, subject to the provisions of paragraph 1.d. of this section; also, regular contributions made or costs incurred for more than a weekly period (but not less often than quarterly) under plans, funds, or programs which cover the particular weekly period, are deemed to be constructively made or incurred during such weekly period. Such laborers and mechanics shall be paid the appropriate wage rate and fringe benefits on the wage determination for the classification of work actually performed, without regard to skill, except as provided in 29 CFR 5.5(a)(4). Laborers or mechanics performing work in more than one classification may be compensated at the rate specified for each classification for the time actually worked therein: Provided, That the employer's payroll records accurately set forth the time spent in each classification in which work is performed. The wage determination (including any additional classification and wage rates conformed under paragraph 1.b. of this section) and the Davis-Bacon poster (WH-1321) shall be posted at all times by the contractor and its subcontractors at the site of the work in a prominent and accessible place where it can be easily seen by the workers.

b.(1) The contracting officer shall require that any class of laborers or mechanics, including helpers, which is not listed in the wage determination and which is to be employed under the contract shall be classified in conformance with the wage determination. The contracting officer shall approve an additional classification and wage rate and fringe benefits therefore only when the following criteria have been met:

(i) The work to be performed by the classification requested is not performed by a classification in the wage determination; and

(ii) The classification is utilized in the area by the construction industry; and

(iii) The proposed wage rate, including any bona fide fringe benefits, bears a reasonable relationship to the wage rates contained in the wage determination.

(2) If the contractor and the laborers and mechanics to be employed in the classification (if known), or their representatives, and the contracting officer agree on the classification and wage rate (including the amount designated for fringe benefits where appropriate), a report of the action taken shall be sent by the contracting officer to the Administrator of the Wage and Hour Division, U.S. Department of Labor, Washington, DC 20210. The Administrator, or an authorized representative, will approve, modify, or disapprove every additional classification action within 30 days of receipt and so advise the contracting officer or will notify the contracting officer within the 30-day period that additional time is necessary.

(3) In the event the contractor, the laborers or mechanics to be employed in the classification or their representatives, and the contracting officer do not agree on the proposed classification and wage rate (including the amount designated for fringe benefits, where appropriate), the contracting officer shall refer the questions, including the views of all interested parties and the recommendation of the contracting officer, to the Administrator for determination. The Administrator, or an authorized representative, will issue a determination within 30 days of receipt and so advise the contracting officer or will notify the contracting officer within the 30-day period that additional time is necessary.

(4) The wage rate (including fringe benefits where appropriate) determined pursuant to paragraphs 1.b.(2) or 1.b.(3) of this section, shall be paid to all workers performing work in the classification under this contract from the first day on which work is performed in the classification.

c. Whenever the minimum wage rate prescribed in the contract for a class of laborers or mechanics includes a fringe benefit which is not expressed as an hourly rate, the contractor shall either pay the benefit as stated in the wage determination or shall pay another bona fide fringe benefit or an hourly cash equivalent thereof.

d. If the contractor does not make payments to a trustee or other third person, the contractor may consider as part of the wages of any laborer or mechanic the amount of any costs reasonably anticipated in providing bona fide fringe benefits under a plan or program. Provided, That the Secretary of Labor has found, upon the written request of the contractor, that the applicable standards of the Davis-Bacon Act have been met. The Secretary of Labor may require the contractor to set aside in a separate account assets for the meeting of obligations under the plan or program.

2. Withholding (29 CFR 5.5)

The contracting agency shall upon its own action or upon written request of an authorized representative of the Department of Labor, withhold or cause to be withheld from the contractor under this contract, or any other Federal contract with the same prime contractor, or any other federally-assisted contract subject to Davis-Bacon prevailing wage requirements, which is held by the same prime contractor, so much of the accrued payments or advances as may be considered necessary to pay laborers and mechanics,

including apprentices, trainees, and helpers, employed by the contractor or any subcontractor the full amount of wages required by the contract. In the event of failure to pay any laborer or mechanic, including any apprentice, trainee, or helper, employed or working on the site of the work, all or part of the wages required by the contract, the contracting agency may, after written notice to the contractor, take such action as may be necessary to cause the suspension of any further payment, advance, or guarantee of funds until such violations have ceased.

3. Payrolls and basic records (29 CFR 5.5)

a. Payrolls and basic records relating thereto shall be maintained by the contractor during the course of the work and preserved for a period of three years thereafter for all laborers and mechanics working at the site of the work. Such records shall contain the name, address, and social security number of each such worker, his or her correct classification, hourly rates of wages paid (including rates of contributions or costs anticipated for bona fide fringe benefits or cash equivalents thereof of the types described in section 1(b)(2)(B) of the Davis-Bacon Act), daily and weekly number of hours worked, deductions made and actual wages paid. Whenever the Secretary of Labor has found under 29 CFR 5.5(a)(1)(iv) that the wages of any laborer or mechanic include the amount of any costs reasonably anticipated in providing benefits under a plan or program described in section 1(b)(2)(B) of the Davis-Bacon Act, the contractor shall maintain records which show that the commitment to provide such benefits is enforceable, that the plan or program is financially responsible, and that the plan or program has been communicated in writing to the laborers or mechanics affected, and records which show the costs anticipated or the actual cost incurred in providing such benefits. Contractors employing apprentices or trainees under approved programs shall maintain written evidence of the registration of apprenticeship programs and certification of trainee programs, the registration of the apprentices and trainees, and the ratios and wage rates prescribed in the applicable programs.

b.(1) The contractor shall submit weekly for each week in which any contract work is performed a copy of all payrolls to the contracting agency. The payrolls submitted shall set out accurately and completely all of the information required to be maintained under 29 CFR 5.5(a)(3)(i), except that full social security numbers and home addresses shall not be included on weekly transmittals. Instead the payrolls shall only need to include an individually identifying number for each employee (e.g., the last four digits of the employee's social security number). The required weekly payroll information may be submitted in any form desired. Optional Form WH-347 is available for this purpose from the Wage and Hour Division Web site. The prime contractor is responsible for the submission of copies of payrolls by all subcontractors. Contractors and subcontractors shall maintain the full social security number and current address of each covered worker, and shall provide them upon request to the contracting agency for transmission to the State DOT, the FHWA or the Wage and Hour Division of the Department of Labor for purposes of an investigation or audit of compliance with prevailing wage requirements. It is not a violation of this section for a prime contractor to require a subcontractor to provide addresses and social security numbers to the prime contractor for its own records, without weekly submission to the contracting agency.

(2) Each payroll submitted shall be accompanied by a "Statement of Compliance," signed by the contractor or

subcontractor or his or her agent who pays or supervises the payment of the persons employed under the contract and shall certify the following:

(i) That the payroll for the payroll period contains the information required to be provided under 29 CFR 5.5(a)(3)(ii), the appropriate information is being maintained under 29 CFR 5.5(a)(3)(i), and that such information is correct and complete;

(ii) That each laborer or mechanic (including each helper, apprentice, and trainee) employed on the contract during the payroll period has been paid the full weekly wages earned, without rebate, either directly or indirectly, and that no deductions have been made either directly or indirectly from the full wages earned, other than permissible deductions as set forth in 29 CFR part 3;

(iii) That each laborer or mechanic has been paid not less than the applicable wage rates and fringe benefits or cash equivalents for the classification of work performed, as specified in the applicable wage determination incorporated into the contract.

(3) The weekly submission of a properly executed certification set forth on the reverse side of Optional Form WH-347 shall satisfy the requirement for submission of the "Statement of Compliance" required by paragraph 3.b.(2) of this section.

(4) The falsification of any of the above certifications may subject the contractor or subcontractor to civil or criminal prosecution under 18 U.S.C. 1001 and 31 U.S.C. 231.

c. The contractor or subcontractor shall make the records required under paragraph 3.a. of this section available for inspection, copying, or transcription by authorized representatives of the contracting agency, the State DOT, the FHWA, or the Department of Labor, and shall permit such representatives to interview employees during working hours on the job. If the contractor or subcontractor fails to submit the required records or to make them available, the FHWA may, after written notice to the contractor, the contracting agency or the State DOT, take such action as may be necessary to cause the suspension of any further payment, advance, or guarantee of funds. Furthermore, failure to submit the required records upon request or to make such records available may be grounds for debarment action pursuant to 29 CFR 5.12.

4. Apprentices and trainees (29 CFR 5.5)

a. Apprentices (programs of the USDOL).

Apprentices will be permitted to work at less than the predetermined rate for the work they performed when they are employed pursuant to and individually registered in a bona fide apprenticeship program registered with the U.S. Department of Labor, Employment and Training Administration, Office of Apprenticeship Training, Employer and Labor Services, or with a State Apprenticeship Agency recognized by the Office, or if a person is employed in his or her first 90 days of probationary employment as an apprentice in such an apprenticeship program, who is not individually registered in the program, but who has been certified by the Office of Apprenticeship Training, Employer and Labor Services or a State

Apprenticeship Agency (where appropriate) to be eligible for probationary employment as an apprentice.

The allowable ratio of apprentices to journeymen on the job site in any craft classification shall not be greater than the ratio permitted to the contractor as to the entire work force under the registered program. Any worker listed on a payroll at an apprentice wage rate, who is not registered or otherwise employed as stated above, shall be paid not less than the applicable wage rate on the wage determination for the classification of work actually performed. In addition, any apprentice performing work on the job site in excess of the ratio permitted under the registered program shall be paid not less than the applicable wage rate on the wage determination for the work actually performed. Where a contractor is performing construction on a project in a locality other than that in which its program is registered, the ratios and wage rates (expressed in percentages of the journeyman's hourly rate) specified in the contractor's or subcontractor's registered program shall be observed.

Every apprentice must be paid at not less than the rate specified in the registered program for the apprentice's level of progress, expressed as a percentage of the journeymen hourly rate specified in the applicable wage determination. Apprentices shall be paid fringe benefits in accordance with the provisions of the apprenticeship program. If the apprenticeship program does not specify fringe benefits, apprentices must be paid the full amount of fringe benefits listed on the wage determination for the applicable classification. If the Administrator determines that a different practice prevails for the applicable apprentice classification, fringes shall be paid in accordance with that determination.

In the event the Office of Apprenticeship Training, Employer and Labor Services, or a State Apprenticeship Agency recognized by the Office, withdraws approval of an apprenticeship program, the contractor will no longer be permitted to utilize apprentices at less than the applicable predetermined rate for the work performed until an acceptable program is approved.

b. Trainees (programs of the USDOL).

Except as provided in 29 CFR 5.16, trainees will not be permitted to work at less than the predetermined rate for the work performed unless they are employed pursuant to and individually registered in a program which has received prior approval, evidenced by formal certification by the U.S. Department of Labor, Employment and Training Administration.

The ratio of trainees to journeymen on the job site shall not be greater than permitted under the plan approved by the Employment and Training Administration.

Every trainee must be paid at not less than the rate specified in the approved program for the trainee's level of progress, expressed as a percentage of the journeyman hourly rate specified in the applicable wage determination. Trainees shall be paid fringe benefits in accordance with the provisions of the trainee program. If the trainee program does not mention fringe benefits, trainees shall be paid the full amount of fringe benefits listed on the wage determination unless the Administrator of the Wage and Hour Division determines that there is an apprenticeship program associated with the

corresponding journeyman wage rate on the wage determination which provides for less than full fringe benefits for apprentices. Any employee listed on the payroll at a trainee rate who is not registered and participating in a training plan approved by the Employment and Training Administration shall be paid not less than the applicable wage rate on the wage determination for the classification of work actually performed. In addition, any trainee performing work on the job site in excess of the ratio permitted under the registered program shall be paid not less than the applicable wage rate on the wage determination for the work actually performed.

In the event the Employment and Training Administration withdraws approval of a training program, the contractor will no longer be permitted to utilize trainees at less than the applicable predetermined rate for the work performed until an acceptable program is approved.

c. Equal employment opportunity. The utilization of apprentices, trainees and journeymen under this part shall be in conformity with the equal employment opportunity requirements of Executive Order 11246, as amended, and 29 CFR part 30.

d. Apprentices and Trainees (programs of the U.S. DOT).

Apprentices and trainees working under apprenticeship and skill training programs which have been certified by the Secretary of Transportation as promoting EEO in connection with Federal-aid highway construction programs are not subject to the requirements of paragraph 4 of this Section IV. 23 CFR 230.111(e)(2). The straight time hourly wage rates for apprentices and trainees under such programs will be established by the particular programs. The ratio of apprentices and trainees to journeymen shall not be greater than permitted by the terms of the particular program.

5. Compliance with Copeland Act requirements. The contractor shall comply with the requirements of 29 CFR part 3, which are incorporated by reference in this contract as provided in 29 CFR 5.5.

6. Subcontracts. The contractor or subcontractor shall insert Form FHWA-1273 in any subcontracts and also require the subcontractors to include Form FHWA-1273 in any lower tier subcontracts. The prime contractor shall be responsible for the compliance by any subcontractor or lower tier subcontractor with all the contract clauses in 29 CFR 5.5.

7. Contract termination: debarment. A breach of the contract clauses in 29 CFR 5.5 may be grounds for termination of the contract, and for debarment as a contractor and a subcontractor as provided in 29 CFR 5.12.

8. Compliance with Davis-Bacon and Related Act requirements. All rulings and interpretations of the Davis-Bacon and Related Acts contained in 29 CFR parts 1, 3, and 5 are herein incorporated by reference in this contract as provided in 29 CFR 5.5.

9. Disputes concerning labor standards. As provided in 29 CFR 5.5, disputes arising out of the labor standards provisions of this contract shall not be subject to the general disputes clause of this contract. Such disputes shall be resolved in accordance with the procedures of the Department of Labor

set forth in 29 CFR parts 5, 6, and 7. Disputes within the meaning of this clause include disputes between the contractor (or any of its subcontractors) and the contracting agency, the U.S. Department of Labor, or the employees or their representatives.

10. Certification of eligibility (29 CFR 5.5)

a. By entering into this contract, the contractor certifies that neither it (nor he or she) nor any person or firm who has an interest in the contractor's firm is a person or firm ineligible to be awarded Government contracts by virtue of section 3(a) of the Davis-Bacon Act or 29 CFR 5.12(a)(1).

b. No part of this contract shall be subcontracted to any person or firm ineligible for award of a Government contract by virtue of section 3(a) of the Davis-Bacon Act or 29 CFR 5.12(a)(1).

c. The penalty for making false statements is prescribed in the U.S. Criminal Code, 18 U.S.C. 1001.

V. CONTRACT WORK HOURS AND SAFETY STANDARDS ACT

Pursuant to 29 CFR 5.5(b), the following clauses apply to any Federal-aid construction contract in an amount in excess of \$100,000 and subject to the overtime provisions of the Contract Work Hours and Safety Standards Act. These clauses shall be inserted in addition to the clauses required by 29 CFR 5.5(a) or 29 CFR 4.6. As used in this paragraph, the terms laborers and mechanics include watchmen and guards.

1. Overtime requirements. No contractor or subcontractor contracting for any part of the contract work which may require or involve the employment of laborers or mechanics shall require or permit any such laborer or mechanic in any workweek in which he or she is employed on such work to work in excess of forty hours in such workweek unless such laborer or mechanic receives compensation at a rate not less than one and one-half times the basic rate of pay for all hours worked in excess of forty hours in such workweek. 29 CFR 5.5.

2. Violation; liability for unpaid wages; liquidated damages. In the event of any violation of the clause set forth in paragraph 1 of this section, the contractor and any subcontractor responsible therefor shall be liable for the unpaid wages. In addition, such contractor and subcontractor shall be liable to the United States (in the case of work done under contract for the District of Columbia or a territory, to such District or to such territory), for liquidated damages. Such liquidated damages shall be computed with respect to each individual laborer or mechanic, including watchmen and guards, employed in violation of the clause set forth in paragraph 1 of this section, in the sum currently provided in 29 CFR 5.5(b)(2)* for each calendar day on which such individual was required or permitted to work in excess of the standard workweek of forty hours without payment of the overtime wages required by the clause set forth in paragraph 1 of this section. 29 CFR 5.5.

* \$27 as of January 23, 2019 (See 84 FR 213-01, 218) as may be adjusted annually by the Department of Labor; pursuant to the Federal Civil Penalties Inflation Adjustment Act of 1990).

3. Withholding for unpaid wages and liquidated damages.

The FHWA or the contacting agency shall upon its own action or upon written request of an authorized representative of the Department of Labor withhold or cause to be withheld, from any moneys payable on account of work performed by the contractor or subcontractor under any such contract or any other Federal contract with the same prime contractor, or any other federally-assisted contract subject to the Contract Work Hours and Safety Standards Act, which is held by the same prime contractor, such sums as may be determined to be necessary to satisfy any liabilities of such contractor or subcontractor for unpaid wages and liquidated damages as provided in the clause set forth in paragraph 2 of this section. 29 CFR 5.5.

4. Subcontracts. The contractor or subcontractor shall insert in any subcontracts the clauses set forth in paragraphs 1 through 4 of this section and also a clause requiring the subcontractors to include these clauses in any lower tier subcontracts. The prime contractor shall be responsible for compliance by any subcontractor or lower tier subcontractor with the clauses set forth in paragraphs 1 through 4 of this section. 29 CFR 5.5.

VI. SUBLETTING OR ASSIGNING THE CONTRACT

This provision is applicable to all Federal-aid construction contracts on the National Highway System pursuant to 23 CFR 635.116.

1. The contractor shall perform with its own organization contract work amounting to not less than 30 percent (or a greater percentage if specified elsewhere in the contract) of the total original contract price, excluding any specialty items designated by the contracting agency. Specialty items may be performed by subcontract and the amount of any such specialty items performed may be deducted from the total original contract price before computing the amount of work required to be performed by the contractor's own organization (23 CFR 635.116).

a. The term "perform work with its own organization" in paragraph 1 of Section VI refers to workers employed or leased by the prime contractor, and equipment owned or rented by the prime contractor, with or without operators. Such term does not include employees or equipment of a subcontractor or lower tier subcontractor, agents of the prime contractor, or any other assignees. The term may include payments for the costs of hiring leased employees from an employee leasing firm meeting all relevant Federal and State regulatory requirements. Leased employees may only be included in this term if the prime contractor meets all of the following conditions: (based on longstanding interpretation)

- (1) the prime contractor maintains control over the supervision of the day-to-day activities of the leased employees;
- (2) the prime contractor remains responsible for the quality of the work of the leased employees;
- (3) the prime contractor retains all power to accept or exclude individual employees from work on the project; and
- (4) the prime contractor remains ultimately responsible for the payment of predetermined minimum wages, the submission of payrolls, statements of compliance and all other Federal regulatory requirements.

b. "Specialty Items" shall be construed to be limited to work that requires highly specialized knowledge, abilities, or

equipment not ordinarily available in the type of contracting organizations qualified and expected to bid or propose on the contract as a whole and in general are to be limited to minor components of the overall contract. 23 CFR 635.102.

2. Pursuant to 23 CFR 635.116(a), the contract amount upon which the requirements set forth in paragraph (1) of Section VI is computed includes the cost of material and manufactured products which are to be purchased or produced by the contractor under the contract provisions.

3. Pursuant to 23 CFR 635.116(c), the contractor shall furnish (a) a competent superintendent or supervisor who is employed by the firm, has full authority to direct performance of the work in accordance with the contract requirements, and is in charge of all construction operations (regardless of who performs the work) and (b) such other of its own organizational resources (supervision, management, and engineering services) as the contracting officer determines is necessary to assure the performance of the contract.

4. No portion of the contract shall be sublet, assigned or otherwise disposed of except with the written consent of the contracting officer, or authorized representative, and such consent when given shall not be construed to relieve the contractor of any responsibility for the fulfillment of the contract. Written consent will be given only after the contracting agency has assured that each subcontract is evidenced in writing and that it contains all pertinent provisions and requirements of the prime contract. (based on longstanding interpretation of 23 CFR 635.116).

5. The 30-percent self-performance requirement of paragraph (1) is not applicable to design-build contracts; however, contracting agencies may establish their own self-performance requirements. 23 CFR 635.116(d).

VII. SAFETY: ACCIDENT PREVENTION

This provision is applicable to all Federal-aid construction contracts and to all related subcontracts.

1. In the performance of this contract the contractor shall comply with all applicable Federal, State, and local laws governing safety, health, and sanitation (23 CFR Part 635). The contractor shall provide all safeguards, safety devices and protective equipment and take any other needed actions as it determines, or as the contracting officer may determine, to be reasonably necessary to protect the life and health of employees on the job and the safety of the public and to protect property in connection with the performance of the work covered by the contract. 23 CFR 635.108.

2. It is a condition of this contract, and shall be made a condition of each subcontract, which the contractor enters into pursuant to this contract, that the contractor and any subcontractor shall not permit any employee, in performance of the contract, to work in surroundings or under conditions which are unsanitary, hazardous or dangerous to his/her health or safety, as determined under construction safety and health standards (29 CFR Part 1926) promulgated by the Secretary of Labor, in accordance with Section 107 of the Contract Work Hours and Safety Standards Act (40 U.S.C. 3704). 29 CFR 1926.10.

3. Pursuant to 29 CFR 1926.3, it is a condition of this contract that the Secretary of Labor or authorized representative thereof, shall have right of entry to any site of contract performance to inspect or investigate the matter of compliance

with the construction safety and health standards and to carry out the duties of the Secretary under Section 107 of the Contract Work Hours and Safety Standards Act (40 U.S.C. 3704).

VIII. FALSE STATEMENTS CONCERNING HIGHWAY PROJECTS

This provision is applicable to all Federal-aid construction contracts and to all related subcontracts.

In order to assure high quality and durable construction in conformity with approved plans and specifications and a high degree of reliability on statements and representations made by engineers, contractors, suppliers, and workers on Federal-aid highway projects, it is essential that all persons concerned with the project perform their functions as carefully, thoroughly, and honestly as possible. Willful falsification, distortion, or misrepresentation with respect to any facts related to the project is a violation of Federal law. To prevent any misunderstanding regarding the seriousness of these and similar acts, Form FHWA-1022 shall be posted on each Federal-aid highway project (23 CFR Part 635) in one or more places where it is readily available to all persons concerned with the project:

18 U.S.C. 1020 reads as follows:

"Whoever, being an officer, agent, or employee of the United States, or of any State or Territory, or whoever, whether a person, association, firm, or corporation, knowingly makes any false statement, false representation, or false report as to the character, quality, quantity, or cost of the material used or to be used, or the quantity or quality of the work performed or to be performed, or the cost thereof in connection with the submission of plans, maps, specifications, contracts, or costs of construction on any highway or related project submitted for approval to the Secretary of Transportation; or

Whoever knowingly makes any false statement, false representation, false report or false claim with respect to the character, quality, quantity, or cost of any work performed or to be performed, or materials furnished or to be furnished, in connection with the construction of any highway or related project approved by the Secretary of Transportation; or

Whoever knowingly makes any false statement or false representation as to material fact in any statement, certificate, or report submitted pursuant to provisions of the Federal-aid Roads Act approved July 11, 1916, (39 Stat. 355), as amended and supplemented;

Shall be fined under this title or imprisoned not more than 5 years or both."

IX. IMPLEMENTATION OF CLEAN AIR ACT AND FEDERAL WATER POLLUTION CONTROL ACT (42 U.S.C. 7606; 2 CFR 200.88; EO 11738)

This provision is applicable to all Federal-aid construction contracts in excess of \$150,000 and to all related subcontracts. 48 CFR 2.101; 2 CFR 200.326.

By submission of this bid/proposal or the execution of this contract or subcontract, as appropriate, the bidder, proposer, Federal-aid construction contractor, subcontractor, supplier, or vendor agrees to comply with all applicable standards, orders

or regulations issued pursuant to the Clean Air Act (42 U.S.C. 7401-7671q) and the Federal Water Pollution Control Act, as amended (33 U.S.C. 1251-1387). Violations must be reported to the Federal Highway Administration and the Regional Office of the Environmental Protection Agency. 2 CFR Part 200, Appendix II.

The contractor agrees to include or cause to be included the requirements of this Section in every subcontract, and further agrees to take such action as the contracting agency may direct as a means of enforcing such requirements. 2 CFR 200.326.

X. CERTIFICATION REGARDING DEBARMENT, SUSPENSION, INELIGIBILITY AND VOLUNTARY EXCLUSION

This provision is applicable to all Federal-aid construction contracts, design-build contracts, subcontracts, lower-tier subcontracts, purchase orders, lease agreements, consultant contracts or any other covered transaction requiring FHWA approval or that is estimated to cost \$25,000 or more – as defined in 2 CFR Parts 180 and 1200. 2 CFR 180.220 and 1200.220.

1. Instructions for Certification – First Tier Participants:

a. By signing and submitting this proposal, the prospective first tier participant is providing the certification set out below.

b. The inability of a person to provide the certification set out below will not necessarily result in denial of participation in this covered transaction. The prospective first tier participant shall submit an explanation of why it cannot provide the certification set out below. The certification or explanation will be considered in connection with the department or agency's determination whether to enter into this transaction. However, failure of the prospective first tier participant to furnish a certification or an explanation shall disqualify such a person from participation in this transaction. 2 CFR 180.320.

c. The certification in this clause is a material representation of fact upon which reliance was placed when the contracting agency determined to enter into this transaction. If it is later determined that the prospective participant knowingly rendered an erroneous certification, in addition to other remedies available to the Federal Government, the contracting agency may terminate this transaction for cause of default. 2 CFR 180.325.

d. The prospective first tier participant shall provide immediate written notice to the contracting agency to whom this proposal is submitted if any time the prospective first tier participant learns that its certification was erroneous when submitted or has become erroneous by reason of changed circumstances. 2 CFR 180.345 and 180.350.

e. The terms "covered transaction," "debarred," "suspended," "ineligible," "participant," "person," "principal," and "voluntarily excluded," as used in this clause, are defined in 2 CFR Parts 180, Subpart I, 180.900-180.1020, and 1200. "First Tier Covered Transactions" refers to any covered transaction between a recipient or subrecipient of Federal funds and a participant (such as the prime or general contract). "Lower Tier Covered Transactions" refers to any covered transaction under a First Tier Covered Transaction (such as subcontracts). "First Tier Participant" refers to the participant

who has entered into a covered transaction with a recipient or subrecipient of Federal funds (such as the prime or general contractor). "Lower Tier Participant" refers any participant who has entered into a covered transaction with a First Tier Participant or other Lower Tier Participants (such as subcontractors and suppliers).

f. The prospective first tier participant agrees by submitting this proposal that, should the proposed covered transaction be entered into, it shall not knowingly enter into any lower tier covered transaction with a person who is debarred, suspended, declared ineligible, or voluntarily excluded from participation in this covered transaction, unless authorized by the department or agency entering into this transaction. 2 CFR 180.330.

g. The prospective first tier participant further agrees by submitting this proposal that it will include the clause titled "Certification Regarding Debarment, Suspension, Ineligibility and Voluntary Exclusion-Lower Tier Covered Transactions," provided by the department or contracting agency, entering into this covered transaction, without modification, in all lower tier covered transactions and in all solicitations for lower tier covered transactions exceeding the \$25,000 threshold. 2 CFR 180.220 and 180.300.

h. A participant in a covered transaction may rely upon a certification of a prospective participant in a lower tier covered transaction that is not debarred, suspended, ineligible, or voluntarily excluded from the covered transaction, unless it knows that the certification is erroneous. 2 CFR 180.300; 180.320, and 180.325. A participant is responsible for ensuring that its principals are not suspended, debarred, or otherwise ineligible to participate in covered transactions. 2 CFR 180.335. To verify the eligibility of its principals, as well as the eligibility of any lower tier prospective participants, each participant may, but is not required to, check the System for Award Management website (<https://www.sam.gov/>). 2 CFR 180.300, 180.320, and 180.325.

i. Nothing contained in the foregoing shall be construed to require the establishment of a system of records in order to render in good faith the certification required by this clause. The knowledge and information of the prospective participant is not required to exceed that which is normally possessed by a prudent person in the ordinary course of business dealings.

j. Except for transactions authorized under paragraph (f) of these instructions, if a participant in a covered transaction knowingly enters into a lower tier covered transaction with a person who is suspended, debarred, ineligible, or voluntarily excluded from participation in this transaction, in addition to other remedies available to the Federal Government, the department or agency may terminate this transaction for cause or default. 2 CFR 180.325.

2. Certification Regarding Debarment, Suspension, Ineligibility and Voluntary Exclusion – First Tier Participants:

a. The prospective first tier participant certifies to the best of its knowledge and belief, that it and its principals:

(1) Are not presently debarred, suspended, proposed for debarment, declared ineligible, or voluntarily excluded from participating in covered transactions by any Federal department or agency, 2 CFR 180.335;

(2) Have not within a three-year period preceding this proposal been convicted of or had a civil judgment rendered against them for commission of fraud or a criminal offense in connection with obtaining, attempting to obtain, or performing a public (Federal, State, or local) transaction or contract under a public transaction; violation of Federal or State antitrust statutes or commission of embezzlement, theft, forgery, bribery, falsification or destruction of records, making false statements, or receiving stolen property, 2 CFR 180.800;

(3) Are not presently indicted for or otherwise criminally or civilly charged by a governmental entity (Federal, State or local) with commission of any of the offenses enumerated in paragraph (a)(2) of this certification, 2 CFR 180.700 and 180.800; and

(4) Have not within a three-year period preceding this application/proposal had one or more public transactions (Federal, State or local) terminated for cause or default. 2 CFR 180.335(d).

(5) Are not a corporation that has been convicted of a felony violation under any Federal law within the two-year period preceding this proposal (USDOT Order 4200.6 implementing appropriations act requirements); and

(6) Are not a corporation with any unpaid Federal tax liability that has been assessed, for which all judicial and administrative remedies have been exhausted, or have lapsed, and that is not being paid in a timely manner pursuant to an agreement with the authority responsible for collecting the tax liability (USDOT Order 4200.6 implementing appropriations act requirements).

b. Where the prospective participant is unable to certify to any of the statements in this certification, such prospective participant should attach an explanation to this proposal. 2 CFR 180.335 and 180.340.

3. Instructions for Certification - Lower Tier Participants:

(Applicable to all subcontracts, purchase orders, and other lower tier transactions requiring prior FHWA approval or estimated to cost \$25,000 or more - 2 CFR Parts 180 and 1200). 2 CFR 180.220 and 1200.220.

a. By signing and submitting this proposal, the prospective lower tier participant is providing the certification set out below.

b. The certification in this clause is a material representation of fact upon which reliance was placed when this transaction was entered into. If it is later determined that the prospective lower tier participant knowingly rendered an erroneous certification, in addition to other remedies available to the Federal Government, the department, or agency with which this transaction originated may pursue available remedies, including suspension and/or debarment.

c. The prospective lower tier participant shall provide immediate written notice to the person to which this proposal is submitted if at any time the prospective lower tier participant learns that its certification was erroneous by reason of changed circumstances. 2 CFR 180.365.

d. The terms "covered transaction," "debarred," "suspended," "ineligible," "participant," "person," "principal," and "voluntarily excluded," as used in this clause, are defined in 2 CFR Parts 180, Subpart I, 180.900 – 180.1020, and 1200. You may contact the person to which this proposal is

submitted for assistance in obtaining a copy of those regulations. "First Tier Covered Transactions" refers to any covered transaction between a recipient or subrecipient of Federal funds and a participant (such as the prime or general contractor). "Lower Tier Covered Transactions" refers to any covered transaction under a First Tier Covered Transaction (such as subcontracts). "First Tier Participant" refers to the participant who has entered into a covered transaction with a recipient or subrecipient of Federal funds (such as the prime or general contractor). "Lower Tier Participant" refers to any participant who has entered into a covered transaction with a First Tier Participant or other Lower Tier Participants (such as subcontractors and suppliers).

e. The prospective lower tier participant agrees by submitting this proposal that, should the proposed covered transaction be entered into, it shall not knowingly enter into any lower tier covered transaction with a person who is debarred, suspended, declared ineligible, or voluntarily excluded from participation in this covered transaction, unless authorized by the department or agency with which this transaction originated. 2 CFR 1200.220 and 1200.332.

f. The prospective lower tier participant further agrees by submitting this proposal that it will include this clause titled "Certification Regarding Debarment, Suspension, Ineligibility and Voluntary Exclusion-Lower Tier Covered Transaction," without modification, in all lower tier covered transactions and in all solicitations for lower tier covered transactions exceeding the \$25,000 threshold. 2 CFR 180.220 and 1200.220.

g. A participant in a covered transaction may rely upon a certification of a prospective participant in a lower tier covered transaction that is not debarred, suspended, ineligible, or voluntarily excluded from the covered transaction, unless it knows that the certification is erroneous. A participant is responsible for ensuring that its principals are not suspended, debarred, or otherwise ineligible to participate in covered transactions. To verify the eligibility of its principals, as well as the eligibility of any lower tier prospective participants, each participant may, but is not required to, check the System for Award Management website (<https://www.sam.gov/>), which is compiled by the General Services Administration. 2 CFR 180.300, 180.320, 180.330, and 180.335.

h. Nothing contained in the foregoing shall be construed to require establishment of a system of records in order to render in good faith the certification required by this clause. The knowledge and information of participant is not required to exceed that which is normally possessed by a prudent person in the ordinary course of business dealings.

i. Except for transactions authorized under paragraph e of these instructions, if a participant in a covered transaction knowingly enters into a lower tier covered transaction with a person who is suspended, debarred, ineligible, or voluntarily excluded from participation in this transaction, in addition to other remedies available to the Federal Government, the department or agency with which this transaction originated may pursue available remedies, including suspension and/or debarment. 2 CFR 180.325.

Certification Regarding Debarment, Suspension, Ineligibility and Voluntary Exclusion--Lower Tier Participants:

1. The prospective lower tier participant certifies, by submission of this proposal, that neither it nor its principals:

(a) is presently debarred, suspended, proposed for debarment, declared ineligible, or voluntarily excluded from participating in covered transactions by any Federal department or agency, 2 CFR 180.355;

(b) is a corporation that has been convicted of a felony violation under any Federal law within the two-year period preceding this proposal (USDOT Order 4200.6 implementing appropriations act requirements); and

(c) is a corporation with any unpaid Federal tax liability that has been assessed, for which all judicial and administrative remedies have been exhausted, or have lapsed, and that is not being paid in a timely manner pursuant to an agreement with the authority responsible for collecting the tax liability. (USDOT Order 4200.6 implementing appropriations act requirements)

2. Where the prospective lower tier participant is unable to certify to any of the statements in this certification, such prospective participant should attach an explanation to this proposal.

XI. CERTIFICATION REGARDING USE OF CONTRACT FUNDS FOR LOBBYING

This provision is applicable to all Federal-aid construction contracts and to all related subcontracts which exceed \$100,000. 49 CFR Part 20, App. A.

1. The prospective participant certifies, by signing and submitting this bid or proposal, to the best of his or her knowledge and belief, that:

a. No Federal appropriated funds have been paid or will be paid, by or on behalf of the undersigned, to any person for influencing or attempting to influence an officer or employee of any Federal agency, a Member of Congress, an officer or employee of Congress, or an employee of a Member of Congress in connection with the awarding of any Federal contract, the making of any Federal grant, the making of any Federal loan, the entering into of any cooperative agreement, and the extension, continuation, renewal, amendment, or modification of any Federal contract, grant, loan, or cooperative agreement.

b. If any funds other than Federal appropriated funds have been paid or will be paid to any person for influencing or attempting to influence an officer or employee of any Federal agency, a Member of Congress, an officer or employee of Congress, or an employee of a Member of Congress in connection with this Federal contract, grant, loan, or cooperative agreement, the undersigned shall complete and submit Standard Form-LLL, "Disclosure Form to Report Lobbying," in accordance with its instructions.

2. This certification is a material representation of fact upon which reliance was placed when this transaction was made or entered into. Submission of this certification is a prerequisite for making or entering into this transaction imposed by 31 U.S.C. 1352. Any person who fails to file the required certification shall be subject to a civil penalty of not less than \$10,000 and not more than \$100,000 for each such failure.

3. The prospective participant also agrees by submitting its bid or proposal that the participant shall require that the language of this certification be included in all lower tier

subcontracts, which exceed \$100,000 and that all such recipients shall certify and disclose accordingly.

XII. USE OF UNITED STATES-FLAG VESSELS:

This provision is applicable to all Federal-aid construction contracts, design-build contracts, subcontracts, lower-tier subcontracts, purchase orders, lease agreements, or any other covered transaction. 46 CFR Part 381.

This requirement applies to material or equipment that is acquired for a specific Federal-aid highway project. 46 CFR 381.7. It is not applicable to goods or materials that come into inventories independent of an FHWA funded-contract.

When oceanic shipments (or shipments across the Great Lakes) are necessary for materials or equipment acquired for a specific Federal-aid construction project, the bidder, proposer, contractor, subcontractor, or vendor agrees:

1. To utilize privately owned United States-flag commercial vessels to ship at least 50 percent of the gross tonnage (computed separately for dry bulk carriers, dry cargo liners, and tankers) involved, whenever shipping any equipment, material, or commodities pursuant to this contract, to the extent such vessels are available at fair and reasonable rates for United States-flag commercial vessels. 46 CFR 381.7.
2. To furnish within 20 days following the date of loading for shipments originating within the United States or within 30 working days following the date of loading for shipments originating outside the United States, a legible copy of a rated, 'on-board' commercial ocean bill-of-lading in English for each shipment of cargo described in paragraph (b)(1) of this section to both the Contracting Officer (through the prime contractor in the case of subcontractor bills-of-lading) and to the Office of Cargo and Commercial Sealift (MAR-620), Maritime Administration, Washington, DC 20590. (MARAD requires copies of the ocean carrier's (master) bills of lading, certified onboard, dated, with rates and charges. These bills of lading may contain business sensitive information and therefore may be submitted directly to MARAD by the Ocean Transportation Intermediary on behalf of the contractor). 46 CFR 381.7.

ATTACHMENT A - EMPLOYMENT AND MATERIALS PREFERENCE FOR APPALACHIAN DEVELOPMENT HIGHWAY SYSTEM OR APPALACHIAN LOCAL ACCESS ROAD CONTRACTS (23 CFR 633, Subpart B, Appendix B)

This provision is applicable to all Federal-aid projects funded under the Appalachian Regional Development Act of 1965.

1. During the performance of this contract, the contractor undertaking to do work which is, or reasonably may be, done as on-site work, shall give preference to qualified persons who regularly reside in the labor area as designated by the DOL wherein the contract work is situated, or the subregion, or the Appalachian counties of the State wherein the contract work is situated, except:

a. To the extent that qualified persons regularly residing in the area are not available.

b. For the reasonable needs of the contractor to employ supervisory or specially experienced personnel necessary to assure an efficient execution of the contract work.

c. For the obligation of the contractor to offer employment to present or former employees as the result of a lawful collective bargaining contract, provided that the number of nonresident persons employed under this subparagraph (1c) shall not exceed 20 percent of the total number of employees employed by the contractor on the contract work, except as provided in subparagraph (4) below.

2. The contractor shall place a job order with the State Employment Service indicating (a) the classifications of the laborers, mechanics and other employees required to perform the contract work, (b) the number of employees required in each classification, (c) the date on which the participant estimates such employees will be required, and (d) any other pertinent information required by the State Employment Service to complete the job order form. The job order may be placed with the State Employment Service in writing or by telephone. If during the course of the contract work, the information submitted by the contractor in the original job order is substantially modified, the participant shall promptly notify the State Employment Service.

3. The contractor shall give full consideration to all qualified job applicants referred to him by the State Employment Service. The contractor is not required to grant employment to any job applicants who, in his opinion, are not qualified to perform the classification of work required.

4. If, within one week following the placing of a job order by the contractor with the State Employment Service, the State Employment Service is unable to refer any qualified job applicants to the contractor, or less than the number requested, the State Employment Service will forward a certificate to the contractor indicating the unavailability of applicants. Such certificate shall be made a part of the contractor's permanent project records. Upon receipt of this certificate, the contractor may employ persons who do not normally reside in the labor area to fill positions covered by the certificate, notwithstanding the provisions of subparagraph (1c) above.

5. The provisions of 23 CFR 633.207(e) allow the contracting agency to provide a contractual preference for the use of mineral resource materials native to the Appalachian region.

6. The contractor shall include the provisions of Sections 1 through 4 of this Attachment A in every subcontract for work which is, or reasonably may be, done as on-site work.

STANDARD SPECIAL PROVISION**ON-THE-JOB TRAINING**

(10-16-07) (Rev. 4-21-15)

Z-10

Description

The North Carolina Department of Transportation will administer a custom version of the Federal On-the-Job Training (OJT) Program, commonly referred to as the Alternate OJT Program. All contractors (existing and newcomers) will be automatically placed in the Alternate Program. Standard OJT requirements typically associated with individual projects will no longer be applied at the project level. Instead, these requirements will be applicable on an annual basis for each contractor administered by the OJT Program Manager.

On the Job Training shall meet the requirements of 23 CFR 230.107 (b), 23 USC – Section 140, this provision and the On-the-Job Training Program Manual.

The Alternate OJT Program will allow a contractor to train employees on Federal, State and privately funded projects located in North Carolina. However, priority shall be given to training employees on NCDOT Federal-Aid funded projects.

Minorities and Women

Developing, training and upgrading of minorities and women toward journeyman level status is a primary objective of this special training provision. Accordingly, the Contractor shall make every effort to enroll minority and women as trainees to the extent that such persons are available within a reasonable area of recruitment. This training commitment is not intended, and shall not be used, to discriminate against any applicant for training, whether a member of a minority group or not.

Assigning Training Goals

The Department, through the OJT Program Manager, will assign training goals for a calendar year based on the contractors' past three years' activity and the contractors' anticipated upcoming year's activity with the Department. At the beginning of each year, all contractors eligible will be contacted by the Department to determine the number of trainees that will be assigned for the upcoming calendar year. At that time the Contractor shall enter into an agreement with the Department to provide a self-imposed on-the-job training program for the calendar year. This agreement will include a specific number of annual training goals agreed to by both parties. The number of training assignments may range from 1 to 15 per contractor per calendar year. The Contractor shall sign an agreement to fulfill their annual goal for the year.\

Training Classifications

The Contractor shall provide on-the-job training aimed at developing full journeyman level workers in the construction craft/operator positions. Preference shall be given to providing training in the following skilled work classifications:

Equipment Operators	Office Engineers
Truck Drivers	Estimators
Carpenters	Iron / Reinforcing Steel Workers
Concrete Finishers	Mechanics
Pipe Layers	Welders

The Department has established common training classifications and their respective training requirements that may be used by the contractors. However, the classifications established are not all-inclusive. Where the training is oriented toward construction applications, training will be allowed in lower-level management positions such as office engineers and estimators. Contractors shall submit new classifications for specific job functions that their employees are performing. The Department will review and recommend for acceptance to FHWA the new classifications proposed by contractors, if applicable. New classifications shall meet the following requirements:

Proposed training classifications are reasonable and realistic based on the job skill classification needs, and

The number of training hours specified in the training classification is consistent with common practices and provides enough time for the trainee to obtain journeyman level status.

The Contractor may allow trainees to be trained by a subcontractor provided that the Contractor retains primary responsibility for meeting the training and this provision is made applicable to the subcontract. However, only the Contractor will receive credit towards the annual goal for the trainee.

Where feasible, 25 percent of apprentices or trainees in each occupation shall be in their first year of apprenticeship or training. The number of trainees shall be distributed among the work classifications on the basis of the contractor's needs and the availability of journeymen in the various classifications within a reasonable area of recruitment.

No employee shall be employed as a trainee in any classification in which they have successfully completed a training course leading to journeyman level status or in which they have been employed as a journeyman.

Records and Reports

The Contractor shall maintain enrollment, monthly and completion reports documenting company compliance under these contract documents. These documents and any other information as requested shall be submitted to the OJT Program Manager.

Upon completion and graduation of the program, the Contractor shall provide each trainee with a certification Certificate showing the type and length of training satisfactorily completed.

Trainee Interviews

All trainees enrolled in the program will receive an initial and Trainee/Post graduate interview conducted by the OJT program staff.

Trainee Wages

Contractors shall compensate trainees on a graduating pay scale based upon a percentage of the prevailing minimum journeyman wages (Davis-Bacon Act). Minimum pay shall be as follows:

60 percent	of the journeyman wage for the first half of the training period
75 percent	of the journeyman wage for the third quarter of the training period
90 percent	of the journeyman wage for the last quarter of the training period

In no instance shall a trainee be paid less than the local minimum wage. The Contractor shall adhere to the minimum hourly wage rate that will satisfy both the NC Department of Labor (NCDOL) and the Department.

Achieving or Failing to Meet Training Goals

The Contractor will be credited for each trainee employed by him on the contract work who is currently enrolled or becomes enrolled in an approved program and who receives training for at least 50 percent of the specific program requirement. Trainees will be allowed to be transferred between projects if required by the Contractor's scheduled workload to meet training goals.

If a contractor fails to attain their training assignments for the calendar year, they may be taken off the NCDOT's Bidders List.

Measurement and Payment

No compensation will be made for providing required training in accordance with these contract documents.

STANDARD SPECIAL PROVISION**MINIMUM WAGES****GENERAL DECISION NC20230090 01/06/2023 NC90**

Z-090

Date: January 6, 2023

General Decision Number: NC20230090 01/06/2023 NC90

Superseded General Decision Numbers: NC20220090

State: North Carolina

Construction Type: HIGHWAY

COUNTIES:

Brunswick	Greene	Onslow
Cumberland	Hoke	Pender
Currituck	Johnston	Pitt
Edgecombe	Nash	Wake
Franklin	New Hanover	Wayne

HIGHWAY CONSTRUCTION PROJECTS (excluding tunnels, building structures in rest area projects & railroad construction; bascule, suspension & spandrel arch bridges designed for commercial navigation, bridges involving marine construction; and other major bridges).

Note: Contracts subject to the Davis-Bacon Act are generally required to pay at least the applicable minimum wage rate required under Executive Order 14026 or Executive Order 13658. Please note that these Executive Orders apply to covered contracts entered into by the federal government that are subject to the Davis-Bacon Act itself, but do not apply to contracts subject only to the Davis-Bacon Related Acts, including those set forth at 29 CFR 5.1(a)(2)-(60).

If the contract is entered into on or after January 30, 2022, or the contract is renewed or extended (e.g., an option is exercised) on or after January 30, 2022:	Executive Order 14026 generally applies to the contract. The contractor must pay all covered workers at least \$16.20 per hour (or the applicable wage rate listed on this wage determination, if it is higher) for all hours spent performing on that contract in 2023.
If the contract was awarded on or between January 1, 2015 and January 29, 2022, and the contract is not renewed or extended on or after January 30, 2022:	Executive Order 13658 generally applies to the contract. The contractor must pay all covered workers at least \$12.15 per hour (or the applicable wage rate listed on this wage determination, if it is higher) for all hours spent performing on that contract in 2023.

The applicable Executive Order minimum wage rate will be adjusted annually. If this contract is covered by one of the Executive Orders and a classification considered necessary for performance of work on the contract does not appear on this wage determination, the contractor must still submit a conformance request.

Additional information on contractor requirements and worker protections under the Executive Orders is available at <http://www.dol.gov/whd/govcontracts>.

Modification Number
0

Publication Date
01/06/2023

SUNC2014-005 11/17/2014

	Rates	Fringes
BLASTER	21.04	
CARPENTER	13.72 **	
CEMENT MASON/CONCRETE FINISHER	14.48 **	
ELECTRICIAN		
Electrician	17.97	
Telecommunications Technician	16.79	.63
IRONWORKER	16.02 **	
LABORER		
Asphalt Raker and Spreader	12.46 **	
Asphalt Screed/Jackman	14.33 **	
Carpenter Tender	12.88 **	
Cement Mason/Concrete Finisher Tender	12.54 **	
Common or General	10.20 **	
Guardrail/Fence Installer	12.87 **	
Pipelayer	12.17 **	
Traffic Signal/Lighting Installer	14.89 **	
PAINTER		
Bridge	24.57	
POWER EQUIPMENT OPERATORS		
Asphalt Broom Tractor	11.85 **	
Bulldozer Fine	17.04	
Bulldozer Rough	14.34 **	
Concrete Grinder/Groover	20.34	2.30
Crane Boom Trucks	20.54	
Crane Other	20.08	
Crane Rough/All-Terrain	20.67	
Drill Operator Rock	14.38 **	
Drill Operator Structure	21.14	
Excavator Fine	16.60	
Excavator Rough	14.00 **	
Grader/Blade Fine	18.47	
Grader/Blade Rough	14.62 **	
Loader 2 Cubic Yards or Less	13.76 **	
Loader Greater Than 2 Cubic Yards	14.14 **	
Material Transfer Vehicle (Shuttle Buggy)	15.18 **	
Mechanic	17.55	
Milling Machine	15.36 **	
Off-Road Hauler/Water Tanker	11.36 **	

	Rates	Fringes
Oiler/Greaser	13.55 **	
Pavement Marking Equipment	12.11 **	
Paver Asphalt	15.59 **	
Paver Concrete	18.20	
Roller Asphalt Breakdown	12.45 **	
Roller Asphalt Finish	13.85 **	
Roller Other	11.36 **	
Scraper Finish	12.71 **	
Scraper Rough	11.35 **	
Slip Form Machine	16.50	
Tack Truck/Distributor Operator	14.52 **	
TRUCK DRIVER		
GVWR of 26,000 Lbs or Less	11.12 **	
GVWR of 26,001 Lbs or Greater	12.37 **	

Welders – Receive rate prescribed for craft performing operation to which welding is incidental.

** Workers in this classification may be entitled to a higher minimum wage under Executive Order 14026 (\$16.20) or 13658 (\$12.15). Please see the Note at the top of the wage determination for more information.

Note: Executive Order (EO) 13706, Establishing Paid Sick Leave for Federal Contractors applies to all contracts subject to the Davis-Bacon Act for which the contract is awarded (and any solicitation was issued) on or after January 1, 2017. If this contract is covered by the EO, the contractor must provide employees with 1 hour of paid sick leave for every 30 hours they work, up to 56 hours of paid sick leave each year. Employees must be permitted to use paid sick leave for their own illness, injury or other health-related needs, including preventive care; to assist a family member (or person who is like family to the employee) who is ill, injured, or has other health-related needs, including preventive care; or for reasons resulting from, or to assist a family member (or person who is like family to the employee) who is a victim of, domestic violence, sexual assault, or stalking. Additional information on contractor requirements and worker protections under the EO is available at <https://www.dol.gov/agencies/whd/government-contracts>.

Unlisted classifications needed for work not included within the scope of the classifications listed may be added after award only as provided in the labor standards contract clauses (29 CFR 5.5(a)(1)(ii)).

The body of each wage determination lists the classification and wage rates that have been found to be prevailing for the cited type(s) of construction in the area covered by the wage determination. The classifications are listed in alphabetical order of "identifiers" that indicate whether the particular rate is a union rate (current union negotiated rate for local), a survey rate (weighted average rate) or a union average rate (weighted union average rate).

Union Rate Identifiers

A four letter classification abbreviation identifier enclosed in dotted lines beginning with characters other than "SU" or "UAVG" denotes that the union classification and rate were prevailing for that classification in the survey. Example: PLUM0198-005 07/01/2014. PLUM is

an abbreviation identifier of the union which prevailed in the survey for this classification, which in this example would be Plumbers. 0198 indicates the local union number or district council number where applicable, i.e., Plumbers Local 0198. The next number, 005 in the example, is an internal number used in processing the wage determination. 07/01/2014 is the effective date of the most current negotiated rate, which in this example is July 1, 2014.

Union prevailing wage rates are updated to reflect all rate changes in the collective bargaining agreement (CBA) governing this classification and rate.

Survey Rate Identifiers

Classifications listed under the "SU" identifier indicate that no one rate prevailed for this classification in the survey and the published rate is derived by computing a weighted average rate based on all the rates reported in the survey for that classification. As this weighted average rate includes all rates reported in the survey, it may include both union and non-union rates. Example: SULA2012-007 5/13/2014. SU indicates the rates are survey rates based on a weighted average calculation of rates and are not majority rates. LA indicates the State of Louisiana. 2012 is the year of survey on which these classifications and rates are based. The next number, 007 in the example, is an internal number used in producing the wage determination. 5/13/2014 indicates the survey completion date for the classifications and rates under that identifier.

Survey wage rates are not updated and remain in effect until a new survey is conducted.

Union Average Rate Identifiers

Classification(s) listed under the UAVG identifier indicate that no single majority rate prevailed for those classifications; however, 100% of the data reported for the classifications was union data. EXAMPLE: UAVG-OH-0010 08/29/2014. UAVG indicates that the rate is a weighted union average rate. OH indicates the state. The next number, 0010 in the example, is an internal number used in producing the wage determination. 08/29/2014 indicates the survey completion date for the classifications and rates under that identifier.

A UAVG rate will be updated once a year, usually in January of each year, to reflect a weighted average of the current negotiated/CBA rate of the union locals from which the rate is based.

WAGE DETERMINATION APPEALS PROCESS

- 1.) Has there been an initial decision in the matter? This can be:
 - * an existing published wage determination
 - * a survey underlying a wage determination
 - * a Wage and Hour Division letter setting forth a position on a wage determination matter
 - * a conformance (additional classification and rate) ruling

On survey related matters, initial contact, including requests for summaries of surveys, should be with the Wage and Hour National Office because National Office has responsibility for the David-Bacon survey program. If the response from this initial contact is not satisfactory, then the process described in 2.) and 3.) should be followed.

With regard to any other matter not yet ripe for the formal process described here, initial contact should be with the Branch of Construction Wage Determinations. Write to:

Branch of Construction Wage Determinations
Wage and Hour Division
U. S. Department of Labor
200 Constitution Avenue, N.W.
Washington, D.C. 20210

- 2.) If the answer to the question in 1.) is yes, then an interested party (those affected by the action) can request review and reconsideration from the Wage and Hour Administrator (See 29 CFR Part 1.8 and 29 CFR Part 7). Write to:

Wage and Hour Administrator
U.S. Department of Labor
200 Constitution Avenue, N.W.
Washington, D.C. 20210

The request should be accompanied by a full statement of the interested party's position and by any information (wage payment data, project description, area practice material, etc.) that the requestor considers relevant to the issue.

- 3.) If the decision of the Administrator is not favorable, an interested party may appeal directly to the Administrative Review Board (formerly the Wage Appeals Board). Write to:

Administrative Review Board
U.S. Department of Labor
200 Constitution Avenue, N.W.
Washington, D.C. 20210

- 4.) All decisions by the Administrative Review Board are final.

END OF GENERAL DECISION

U-6022

TS-1

Wake County

Signals and Intelligent Transportation Systems
Project Special Provisions
(Version 18.7)

Prepared By: Anthony Encarnacion
14-Apr-23

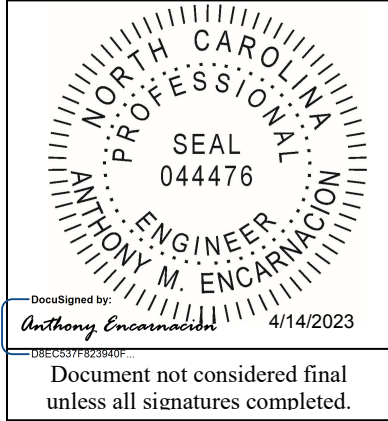

Contents

1. GENERAL REQUIREMENTS5

1.1. CONSTRUCTION METHODS5

 A. Requirements for Historic Areas5

 B. Related Projects5

 C. Sequence of Construction6

1.2. REQUIREMENTS FOR CABLES CROSSING RAILROADS8

 A. Railroad Crossings8

 B. Insurance Requirements8

 C. Flagging Protection or Watchman Service9

 D. Delays Caused by Operations of Others9

 E. Time Extensions9

 F. Cooperation by Others9

 G. Authority of Railroad Engineer9

 H. Interference with Railroad Operations9

 I. Storage of Materials10

 J. Completion and Acceptance of Work10

2. 2018 STANDARD SPECIFICATIONS FOR ROADS & STRUCTURES10

2.1. GENERAL REQUIREMENTS – MATERIALS (1098-1(H))10

2.2. GENERAL REQUIREMENTS – CONSTRUCTION METHODS (1700-3(K))11

2.3. GENERAL REQUIREMENTS – CONSTRUCTION METHODS (1700-3(L))11

2.4. GENERAL REQUIREMENTS – CONSTRUCTION METHODS (1700-3(M))11

2.5. WOOD POLES – CONSTRUCTION METHODS (1720-3)12

3. ADA COMPLIANT PEDESTRIAN TRAFFIC CONTROL DEVICES12

3.1. DESCRIPTION12

3.2. CONSTRUCTION METHODS12

3.3. MEASUREMENT AND PAYMENT12

4. TEMPORARY TRAFFIC CONTROL13

4.1. GENERAL REQUIREMENTS13

4.2. TEMPORARY TRAFFIC CONTROL (TTC)14

4.3. LAW ENFORCEMENT14

4.4. PROJECT REQUIREMENTS14

4.5. MEASUREMENT AND PAYMENT15

5. SIGNAL HEADS15

5.1. MATERIALS15

 A. General:15

 B. Vehicle Signal Heads:17

 C. Pedestrian Signal Heads:20

 D. Signal Cable:21

E.	Modify Existing Vehicle Signal Heads:.....	22
6.	CONTROLLERS WITH CABINETS	22
6.1.	MATERIALS – GENERAL CABINETS	22
6.2.	MATERIALS – TYPE 170E CABINETS	23
A.	Type 170 E Cabinets General:	23
B.	Type 170 E Cabinet Electrical Requirements:	23
C.	Type 170 E Cabinet Physical Requirements:.....	30
D.	Model 2018 Enhanced Conflict Monitor:	33
E.	Preemption and Sign Control Box	43
6.3.	MATERIALS – TYPE 170 DETECTOR SENSOR UNITS	46
6.4.	MATERIALS – TYPE 2070LX CONTROLLERS	46
6.5.	ADDITIONAL CONSTRUCTION METHODS.....	46
6.6.	MEASUREMENT AND PAYMENT	46
7.	JUNCTION BOX MARKERS.....	47
7.1.	DESCRIPTION	47
7.2.	MATERIALS	47
7.3.	CONSTRUCTION METHODS	48
7.4.	MEASUREMENT AND PAYMENT	48
8.	HUB CABINET.....	48
8.1.	DESCRIPTION	48
8.2.	MATERIALS	49
8.3.	ELECTRICAL.....	49
8.4.	CONSTRUCTION METHODS	49
A.	General:	49
B.	Base Mounted:.....	50
8.5.	MEASUREMENT AND PAYMENT	50
9.	ETHERNET EDGE SWITCH.....	50
9.1.	DESCRIPTION	50
A.	Ethernet Edge Switch:	50
B.	Network Management:	50
9.2.	MATERIALS	50
A.	General:	50
B.	Compatibility Acceptance.....	51
C.	Standards:	51
D.	Functional:	51
E.	Physical Features:	52
F.	Management Capabilities:	53
G.	Electrical Specifications:	54
H.	Environmental Specifications:	54
I.	Ethernet Patch Cable:	55
9.3.	CONSTRUCTION METHODS	55
A.	General:	55
B.	Edge Switch:.....	55
9.4.	MEASUREMENT AND PAYMENT.....	55
10.	DIGITAL CCTV CAMERA ASSEMBLY	56
10.1.	DESCRIPTION	56
10.2.	MATERIALS	56
A.	General.....	56
B.	Camera and Lens	56
C.	Camera Housing	58
D.	Pan and Tilt Unit.....	58
E.	Video Ethernet Encoder.....	58
F.	Control Receiver/Driver	58

G.	Electrical.....	59
H.	CCTV Camera Attachment to Pole.....	59
I.	Riser.....	59
J.	Data line Surge Suppression.....	59
K.	POE Injector.....	60
10.3.	CONSTRUCTION METHODS.....	60
A.	General.....	60
B.	Electrical and Mechanical Requirements.....	61
C.	General Test Procedure.....	61
D.	Compatibility Tests.....	62
E.	Operational Field Test (On-Site Commissioning).....	62
F.	Local Field Testing.....	62
G.	Central Operations Testing.....	63
10.4.	MEASUREMENT AND PAYMENT.....	63
11.	ELECTRICAL SERVICE.....	64
11.1.	DESCRIPTION.....	64
11.2.	MATERIALS.....	64
A.	Electrical Service.....	64
B.	Grounding Electrodes (Ground Rods).....	65
C.	Service Conductors.....	65
11.3.	CONSTRUCTION METHODS.....	65
A.	General.....	65
B.	New Electrical Service.....	66
C.	Grounding of Electrical Services.....	66
11.4.	MEASUREMENT AND PAYMENT.....	67
12.	ETHERNET CABLE.....	67
12.1.	DESCRIPTION.....	67
12.2.	MATERIALS.....	67
A.	Ethernet Cable.....	67
B.	Cable Management.....	68
C.	Connectors.....	69
D.	Ethernet Patch Cords.....	69
E.	Environmental Requirements.....	70
12.3.	CONSTRUCTION METHODS.....	70
A.	General.....	70
B.	Aerial Installation.....	70
C.	Messenger Cable Installation.....	70
D.	Underground Installation.....	71
E.	Ethernet Patch Cords.....	71
12.4.	MEASUREMENT AND PAYMENT.....	71
13.	HAND-LASH & AERIAL CABLE PROTECTOR.....	71
13.1.	DESCRIPTION.....	71
13.2.	MATERIALS.....	72
13.3.	MEASUREMENT AND PAYMENT.....	72
14.	CCTV WOOD POLE.....	72
14.1.	DESCRIPTION.....	72
14.2.	MATERIALS.....	72
14.3.	CCTV WOOD POLE.....	72
14.4.	CONSTRUCTION METHODS.....	72
14.5.	MEASUREMENT AND PAYMENT.....	73
15.	AIR TERMINAL & LIGHTNING PROTECTION SYSTEM.....	73
15.1.	DESCRIPTION.....	73
15.2.	MATERIALS.....	73

U-6022

TS-4

Wake County

- A. General..... 73
- B. Wood Pole 73
- C. Copper Lightning Conductor and Ground Rods 74
- 15.3. CONSTRUCTION METHODS 74
 - A. Wood Pole 74
 - B. Copper Lightning Conductor and Ground Rods 74
- 15.4. MEASUREMENT AND PAYMENT 75
- 16. REMOVE EXISTING EQUIPMENT..... 75**
 - 16.1. DESCRIPTION 75
 - 16.2. CONSTRUCTION METHODS 75
 - 16.3. MEASUREMENT AND PAYMENT 75
- 17. OBSERVATION PERIOD..... 75**
 - 17.1. 30-DAY OBSERVATION PERIOD..... 75
 - 17.2. FINAL ACCEPTANCE 76
 - 17.3. MEASUREMENT AND PAYMENT 76

1. GENERAL REQUIREMENTS

1.1. CONSTRUCTION METHODS

A. Requirements for Historic Areas

As shown in the Plans, some work will be conducted within areas determined to contain properties with documented historic significance. If it is necessary to deviate from the Plans in these areas, alert the Engineer to contact the Environmental Analysis Unit, Cultural Resources Section for an effects determination before proceeding.

Avoid damaging or removing sidewalks and curbs within designated historic districts whenever possible. Do not damage, disturb, or remove any existing granite curbs. Where granite curbs conflict with the installation of underground conduit and cable, bore (drill) conduit underneath granite curb. Do not bore through granite curbs. Replace any granite curb damaged due to construction of this project at no cost to the Department.

Where removal and replacement of concrete sidewalk and concrete curb is unavoidable, replace them with concrete materials that match the finish, appearance, and color of the adjacent existing sidewalk as close as technically feasible as determined by the Engineer. Finishes may include, but are not limited to, water-washed, broom, and trowel. The dimensions and the profile (i.e., shape) of the new curbing shall match that of the adjacent existing curbing.

Where removal and replacement of sidewalk constructed of materials other than concrete is unavoidable, replace the sidewalk with in-kind materials that match the finish, appearance, and color of the adjacent existing sidewalk as close as technically feasible as determined by the Engineer. If the sidewalk is constructed of materials such as brick, stone, or pavers, carefully remove and subsequently reinstall the bricks, stones, or pavers using methods approved by the Engineer. Take photographs and make sketches to record the pattern of the existing materials prior to removal. Replace any bricks, stones, or pavers damages due to construction on this project with approved in-kind, matching materials.

Repair and replacement of existing sidewalk will be measured and paid for in accordance with Section 848 of the 2018 Standard Specifications for Roads and Structures.

Complete all repairs with in-kind materials to all sidewalks removed for construction and reopen the repaired and restored sidewalk to pedestrian traffic within five consecutive calendar days following initial removal. If the Contractor fails to repair and reopen a sidewalk in accordance with these Project Special provisions within the time frame specified, the Department reserves the right to make the necessary repairs, and all expenses incurred by the Department in making the repairs and restoring the sidewalk will be deducted from payment due the Contractor, plus \$500 liquidated damage per occasion, per day, or any portion thereof, until corrected.

Do not trim, remove, or damage tree limbs within historic districts. Hand-lashing of aerial cables to messenger cable may be required in some areas due to overhanging and protruding tree limbs along the cable route. When required, hand-lashing will be performed at no additional cost to the Department.

B. Related Projects

Current roadway and transportation projects within the project area may impact traffic signal operations and communications. Coordinate with the Engineer on how to proceed if those projects have not been completed and construction in these areas is on the critical path of the project schedule.

The Department has general maintenance backlog work for public safety that will need to be continued throughout the duration of this project. Coordinate with Engineer for actions to be taken if any maintenance construction prohibits the availability of the traffic signal for construction.

C. Sequence of Construction

Perform construction of the project in the sequence called for in these Project Special Provisions. All work not performed in accord with the sequence of construction must be approved by the Engineer. Adherence to the sequence of construction must be reflected in the Contractor's project schedule and all updates to the project schedule. Construction shall have minimal disruption to the existing signal operations.

At all new and existing intersections maintain existing signal coordination and common controller clock time until final acceptance of the project. All clocks that are updated shall be updated from a single clock source. Review each intersection on a regular basis (no less than one time a week) in the form of a field visit and review the controller clock for drift against the common time source. Reset clock to common time source if it has drifted. Document the field visit and any actions taken in the cabinet's maintenance diary. Record time and date of each visit, activity performed, and person performing visit. Maintain records of clock maintenance activities in a single document and furnish to the Engineer for review upon request. Failure to visit each intersection that is not online to check and update clocks will result in a liquidated damage of \$500 per visit not performed.

For the Sequence of Construction, the Contractor shall perform the work per the following phasing.

Phase 1 – This phase shall consist of installing new infrastructure for the fiber optic communications and includes:

- Installing new messenger cable and guy assemblies throughout the project area. Also, installing communications cable ID markers on messenger cable to identify and reserve fiber optic cable attachment locations on existing utility poles.
- Installing new junction boxes, underground conduit, and pole risers throughout the project area.
- Not disturbing the existing signal cabinets/controller or the existing signal system communications network.

Phase 2 – This phase shall consist of installing new fiber optic communications cables and equipment and includes:

- Installing new fiber optic cables throughout the project area by lashing to aerial messenger cable and/or existing communications cables or pulling through underground conduit.
- Installing new fiber optic splice enclosures and performing splicing where new fiber optic cables connect. No splicing involving existing fiber optic cables shall be performed during this phase.
- Not disturbing the existing signal cabinets/controller or the existing signal system communications network.

U-6022

TS-7

Wake County

Phase 3 – This phase shall consist of preparing the signal system at the Hub cabinet and includes:

- Routing the fiber optic cable that enters the Hub cabinet through new conduit.
- Installing the new fiber optic interconnect center in the Hub cabinet and terminating the fiber optic cable.
- Requesting the Hub cabinet Ethernet switch to be installed by the Department.
- Coordinating with the Engineer to request the ISP circuit to be installed by others.

Phase 4 – This phase shall consist of integrating the Ethernet groups and includes:

- Integrating groups (one group at a time) starting closest to the Hub cabinet and working out towards the farthest extents of the system.
- The Contractor shall complete all work for a given group and verify it is fully functional before starting work in a different group. After taking down an existing communication channel, the contractor must complete all construction for traffic signals in that channel in a time period no greater than two (2) days per traffic signal in that channel. Establish time-based coordination within the limits of the prior closed loop system and maintain controller clocks. Failure to complete all work for a given group and verify it is fully functional before starting work in a different group in a liquidated damage of \$500 per visit not performed.
- Verifying that all existing traffic signal communication channels are still fully functional at the Hub cabinet and Division office.
- Performing signal work (cabinet and controller replacement) for traffic signals within the group.
- Performing CCTV work for proposed and existing CCTV cameras within the group.
- Performing communications work (field Ethernet switch installation) within the group.
- Integrating the field Ethernet switches within the group with the fiber optic communications network and the Hub Ethernet switch at the Hub cabinet.
- Integrating the Ethernet group with the Department's Statewide Signal Communications server to establish communications with the traffic signals.
- Integrating the Ethernet group with the CCTV control software at the State Transportation Operations Center (STOC) to establish communications with the CCTV cameras along with viewing video and controlling PTZ functions.
- Integrate the hub switch with the new ISP circuit for uplink communications to the NCDOT Statewide Signal System. Coordinate all central configuration activities with the Division Traffic Engineer or State Signal Systems Engineer at 919-814-5000.

1.2. REQUIREMENTS FOR CABLES CROSSING RAILROADS

A. Railroad Crossings

Applications for encroachment have been made with Norfolk Southern Corporation (NS), and RJ Corman Railroad Group, for the encroachment agreements necessary under this Contract. Do not commence cable routings over or under railroad-owned facilities until notification and coordination with Engineer and the appropriate Railroad Company has occurred. Install fiber-optic communications cable as shown on the Plans. All work associated with the crossing is to conform to the Railroad Company's specifications.

B. Insurance Requirements

The Department has provided Railroad Protective Liability Insurance to the railroad companies as part of the Department's encroachment agreements with the railroad companies for each of location listed in the table above.

If required by the railroad, pay for railroad personnel to be present when work is performed.

In addition to any other forms of insurance or bonds required under the terms of the Contract and the Standard Specifications, take out and keep in force from the commencement of all construction on railroad right-of-way until the final inspection and acceptance of the project by the Engineer, insurance of the following kinds and amount. It is understood that the amounts specified are minimum amounts and that larger amounts may be carried if so desired. Any insurance taken out due to these requirements shall be subject to the approval of the Engineer, and the Railroad Companies as to form and amount. Furnish satisfactory policies prior to beginning of the work on railroad right-of-way.

Refer to the following web links for more specific insurance requirements and requirements for working on the rights-of-way of each railroad company. In the event of a conflict between the requirements of one or more railroad companies and the requirements contained in the Plans or these Project Special Provisions, the requirements of the railroad company shall govern.

Norfolk Southern:

<http://www.nscorp.com/content/nscorp/en/real-estate/customer-resources/insurance-requirements.html>

http://www.nscorp.com/content/dam/nscorp/ship/shipping-tools/Public_Projects_Manual.pdf

RJ Corman:

<http://www.rjcorman.com/sites/default/files/APPLICATION%20FOR%20ENTRY.pdf>

1. Commercial General Liability Insurance

Furnish evidence to the Engineer of Contractor's commercial General Liability Insurance coverage with a combined single limit of not less than \$2,000,000 for each occurrence for operations performed on the railroad right-of-way. The Contractor's policy shall name the railroad company as an additional insured. If any part of the work is sublet, similar insurance in the same amounts and evidence thereof as required of the Prime Contractor shall be provided by or on behalf of the Subcontractor to cover Subcontractor's operations on the railroad right-of-way.

Keep such insurance in force until final inspection of the project, or that portion or portions within the railroad right-of-way, by the Engineer or, in the case of Subcontractors, until the Contractor furnishes a letter to the Engineer stating that the Subcontractor has completed his/her subcontracted work within the railroad right-of-way to Contractor's satisfaction, and that the

U-6022**TS-9****Wake County**

Contractor will accomplish any additional work necessary on the railroad right-of-way with the Contractor's own forces.

2. Termination of Insurance and Policies to be Submitted

Any insurance policies given hereunder shall cover all Contractor-performed work the Contractor in connection with the work in the introductory paragraph within railroad right-of-way but shall not be liable for accidents occurring after acceptance of the completed project by the Department. Such policies shall contain a clause requiring 30 days written notice be given to the Engineer and to the appropriate Railroad Company, prior to cancellation or change.

Submit to the Engineer the original and one copy of the Commercial General Liability Policy, one certified duplicate copy of all other policies, and certificates of insurance in an original and two copies as required by these Project Special Provisions.

No extra allowance will be made for the insurance required hereunder. The entire cost shall be included in the contract unit price bids for other pay items.

The named insured under the commercial General Liability Insurance Policy is the respective Railroad Company, and the designation of the job site description of work is as follows: All construction on the Norfolk Southern and RJ Corman right-of-way on NCDOT Project No. U-6022 in or near the Town of Fuquay-Varina, North Carolina.

C. Flagging Protection or Watchman Service

Provide 72 hours advance notice to appropriate Railroad Company in order that flagging service can be arranged and provided. Do not undertake any work within the Railroad company right-of-way until the flagman is at the job site.

D. Delays Caused by Operations of Others

Neither the Department nor the Railroad Company assumes any responsibility for any work performed by others in connection with the construction of the project, and the Contractor shall have no claim whatsoever against the Department or the Railroad Company for any inconvenience, delay, or additional cost incurred by the Contractor on account of such operations by others.

E. Time Extensions

No time extensions related to railroad encroachments will be allowed until the related work becomes the controlling factor relative to overall project completion.

F. Cooperation by Others

Cooperate with others participating in the construction of the project to the end that all work may be carried on to the best advantage.

G. Authority of Railroad Engineer

The authorized representative of the Railroad Company, hereinafter referred to as the Railroad Engineer, will have the final authority in all matters affecting the safe maintenance of railroad traffic of his company.

H. Interference with Railroad Operations

Arrange and conduct work so that there will be no interference with railroad operations, including train, signal, telephone and telegraphic services, or damage to the property of the Railroad

Company or to the poles, wire, and other facilities of tenants on the rights-of-way of the Railroad Company. Wherever work is liable to affect the operations or safety of trains, first submit the method of doing such work to the Railroad Engineer for approval. However, such approval will not relieve the Contractor from liability.

Should conditions arising from or in connection with the work, require that immediate and unusual provisions be made to protect train operations and property of the Railroad Company, it shall be a part of the required services by the Contractor to make such provisions and if, in the judgment of the Railroad Engineer such provisions are insufficient, the Railroad Engineer or the Department may, at the expense of the Contractor, require or provide such provisions as may be deemed necessary.

I. Storage of Materials

Do not store materials and equipment where they will interfere with railroad operations, nor on the rights-of-way of the Railroad Company without first having obtained permission from the Railroad Engineer. Such permission will be with the understanding that the Railroad Company will not be liable or damage to such material and equipment from any cause, and that the Railroad Engineer may move or require the Contractor to move, at the Contractor's expense, such material and equipment.

J. Completion and Acceptance of Work

Upon completion of the work, remove from within the limits of the railroad right-of-way all machinery, equipment, surplus materials, or rubbish and leave said rights-of-way in a neat and orderly condition. Acceptance of the work will be contingent upon final inspection by the Department and by the Railroad Company (if required by the Railroad Company) to determine if the work was completed satisfactorily in a manner acceptable to the Department and the Railroad Company.

2. 2018 STANDARD SPECIFICATIONS FOR ROADS & STRUCTURES

The 2018 Standard Specifications are revised as follows:

2.1. GENERAL REQUIREMENTS – Materials (1098-1(H))

Page 10-212, line 12, revise title of section 1098-1(H) from “Electrical Service” to “Electrical Service for Traffic Signals”.

Page 10-212, revise paragraph beginning on line 13 to read “Furnish external electrical service disconnects with a single pole 50 ampere inverse time circuit breaker with at least 10,000 RMS symmetrical amperes short circuit current rating in a lockable NEMA 3R enclosure. For electrical service to an Advanced Transportation Controller (ATC) cabinet, provide a single pole 30 ampere inverse time circuit breaker with at least 10,000 RMS symmetrical amperes short circuit current rating. Ensure service disconnects are listed as meeting UL Standard UL-489 and marked as being suitable for use as service equipment. Fabricate enclosure from galvanized steel and electrostatically apply dry powder paint finish, light gray in color, to yield a minimum thickness of 2.4 mils. Provide ground bus and neutral bus with at least 5 terminals with minimum wire capacity range of number 14 through number 4. Ensure each service has only one disconnecting means in the enclosure. Place barriers in service equipment such that no uninsulated, ungrounded service busbar, or service terminal is exposed.”

2.2. GENERAL REQUIREMENTS – Construction Methods (1700-3(K))

Page 17-4, revise paragraph starting on line 10 to read:

“Where electrical services do not include an external electrical service disconnect, modify service to include electrical service disconnect and a new grounding electrode system.

Provide a grounding electrode system at all new electrical services. All grounding and bonding equipment shall conform to UL Standard 467. Permanently bond grounding conductor to ground rod using an irreversible ground connector. Unless the irreversible ground connectors are designed for use with more than one conductor, only one conductor shall be used with each irreversible ground connector. Ensure all irreversible ground connectors are installed per manufacturer’s installation instructions. Irreversible compression ground connectors requiring the use of a die for installation shall be made using a hydraulic, power, or ratcheting type crimper with appropriate dies. The use of handheld pliers for crimping irreversible compression ground connectors is prohibited.

Modify existing electrical services, as necessary, to meet the grounding requirements of the NEC, these Standard Specifications, and the project plans. Remove any ground rods in the cabinet foundation and install a new grounding electrode system. Cut off abandoned ground rods in the cabinet foundation flush with the foundation surface.

In addition to NEC requirements, test grounding electrode resistance for a maximum of 20 ohms. Furnish and install additional ground rods to grounding electrode system as necessary to meet the Standard Specifications, Standard Drawings, and test requirements. Grounding electrode resistance test shall be verified or witnessed by the Engineer or the Engineer’s designated representative.

Follow test equipment’s procedures for measuring grounding electrode resistance. When using clamp-type ground resistance meters, readings of less than one ohm typically indicate a ground loop. Rework bonding and grounding circuits as necessary to remove ground loop circuits and retest. If a ground loop cannot be identified and removed to allow the proper use of a clamp-type ground resistance meter, use the three-point test method.

Submit a completed Inductive Loop & Grounding Test Form available on the Department’s website.

For ease of inspection, the top of ground rods shall be 12 inches (\pm 1 inch) below finished grade and shall remain exposed until electrical inspection is complete. Provide a length of marker tape 6 inches below finished grade directly over grounding electrodes and conductors.

For ground rods installed in areas where the slope is greater than 4:1, the top of the ground rods shall be a minimum of 24” below finished grade. Provide a length of marker tape 6 inches to 12 inches below finished grade directly over grounding electrodes and conductors.”

2.3. GENERAL REQUIREMENTS – Construction Methods (1700-3(L))

Page 17-4, revise paragraph starting on line 35 to read “Using an approved termination means, connect a #14 AWG minimum, 19-strand copper conductor (Type THWN) with insulation that is green or green with one or more yellow stripes to serve as an equipment grounding conductor to metal poles, vehicular and pedestrian signal pedestals, and other metallic components which are not otherwise bonded through means approved by the Engineer. For traffic signal installations, equipment grounding conductors shall have insulation that is green with one or more yellow stripes.”

2.4. GENERAL REQUIREMENTS – Construction Methods (1700-3(M))

Page 17-4, Replace the sentence beginning on line 41 with “Prior to placing signal in the steady (stop-and-go) mode, the signal should be placed in the flashing mode for up to 7 days or as directed by the Engineer. The signal should not be placed in the steady (stop-and-go) mode on a Saturday or

U-6022

TS-12

Wake County

Sunday without prior approval from the Engineer. Do not place the signal in steady (stop-and-go) mode until inspected and without the prior approval of the Engineer.”

2.5. WOOD POLES – Construction Methods (1720-3)

Page 17-18, revise sentence starting on line 13 to read “On new Department-owned poles, install a grounding system consisting of #6 AWG solid bare copper wire that is connected with an **irreversible ground connector** to a single ground rod installed at base of pole or to the electrical service grounding electrode system located within 10 feet of the pole.”

3. ADA COMPLIANT PEDESTRIAN TRAFFIC CONTROL DEVICES

3.1. DESCRIPTION

Furnish, install, and maintain all ADA compliant pedestrian traffic control devices for existing pedestrian facilities that are disrupted, closed, or relocated by planned work activities.

The ADA compliant pedestrian traffic control devices used to either close, redirect, divert or detour pedestrian traffic are Pedestrian Channelizing Devices, Audible Warning Devices and Temporary Curb Ramps.

3.2. CONSTRUCTION METHODS

The ADA compliant pedestrian traffic control devices involved in the closing or redirecting of pedestrians as designated on the Transportation Management Plan (TMP) shall be manufactured and assembled in accordance with the requirements of the Americans with Disabilities Act (ADA) and be on the NCDOT approved products list.

Pedestrian Channelizing Devices shall be manufactured and assembled to be connected as to eliminate any gaps that allow pedestrians to stray from the channelizing path. Any Pedestrian Channelizing Devices used to close or block a pedestrian facility shall have a “SIDEWALK CLOSED” sign affixed to it and any audible warning devices, if designated on the TMP.

Audible Warning Devices shall be manufactured to include a locator tone activated by a motion sensor and have the ability to program a message for a duration of at least 1 minute. The motion sensor shall have the ability to detect pedestrians a minimum of 10’ away. The voice module may be automatic, or it may be push button activated. If push button activated, it shall be mounted at a height of approximately 3.5 feet, but no more than 4 feet, above the pedestrian facility.

Temporary Curb Ramps shall be manufactured and assembled to meet all of the requirements for persons with walking disabilities, including wheelchair confinement, according to the ADA regulations. All detectable warning features are to be included with these installations.

3.3. MEASUREMENT AND PAYMENT

Pedestrian Channelizing Devices will be measured and paid as the maximum number of linear feet of *Pedestrian Channelizing Devices* furnished, acceptably placed, and in use at any one time during the life of the project.

No direct payment will be made for any sign affixed to a pedestrian channelizing device. Signs mounted to pedestrian channelizing devices will be considered incidental to the device.

U-6022

TS-13

Wake County

Payment will be made under:

Pay Item	Pay Unit
Pedestrian Channelizing Devices.....	Linear Foot

4. TEMPORARY TRAFFIC CONTROL

4.1. GENERAL REQUIREMENTS

Maintain traffic on all roads in accordance with Divisions 10, 11 and 12 of the *2018 Standard Specifications* and the following provisions:

Install Work Zone Advance Warning Signs when work is within 40 ft. from the edge of the travel lane in accordance with Standard Drawing No. 1101.01 of the *2018 Roadway Standard Drawings* prior to beginning any other work. If signs are installed more than 3 calendar days prior to the beginning of work, cover the signs until the work begins. Install each work zone advance warning sign separately and not on the same post or stand with any other sign.

When personnel and/or equipment are working within 15 ft. of an open travel lane, close the nearest open shoulder using Roadway Standard Drawing No. 1101.04 unless the work area is protected by barrier or guardrail, or a lane closure is installed.

When personnel and/or equipment are working on the shoulder adjacent to an undivided facility and within 5 ft. of an open travel lane, close the nearest open travel lane using Roadway Standard Drawing No. 1101.02 of the *2018 Roadway Standard Drawings* unless the work area is protected by barrier or guardrail.

When personnel and/or equipment are working on the shoulder adjacent to a divided facility and within 10 ft. of an open travel lane, close the nearest open travel lane using Roadway Standard Drawing No. 1101.02 of the *2018 Roadway Standard Drawings*, unless the work area is protected by barrier or guardrail.

When personnel and/or equipment are working within a lane of travel of an undivided or divided facility, close the lane using Roadway Standard Drawing No. 1101.02 of the *2018 Roadway Standard Drawings* or as directed by the Engineer. Conduct the work so that all personnel and/or equipment remain within the closed travel lane. Perform work only when weather and visibility conditions allow safe operations as directed by the Engineer.

Do not work simultaneously within 15 ft. on both sides of an open travel way, ramp, or loop within the same location, unless protected with guardrail or barrier.

Remove lane closure devices from the lane when work is not being performed behind the lane closure or when a lane closure is no longer needed or as directed by the Engineer.

U-6022**TS-14****Wake County**

On the through lanes of main arterial roads, do not perform work during the daytime hours. On secondary roads, turn lanes, work may not be performed during the peak hours of 7-9am and 4-7pm, except in the vicinity of a school, in which case the afternoon limitations will extend from 3-7pm.

4.2. TEMPORARY TRAFFIC CONTROL (TTC)

Refer to Standard Drawing No. 1101.02, 1101.03, 1101.04, 1101.11, 1110.01, 1110.02, 1115.01, 1130.01, 1135.01, 1145.01, 1150.01, 1165.01, and 1180.01 of the *2018 Roadway Standard Drawings* when closing a lane of travel or shoulder in the work zone.

Notify the Engineer (30) calendar days prior to any traffic pattern alteration.

Ensure all necessary signing is in place prior to altering any traffic pattern.

When lane closures are not in effect, space channelizing devices in work areas no greater in feet than twice the posted speed limit (MPH), except 10 ft. on-center in radii, and 3 ft. off the edge of an open travelway. Refer to *2018 Standard Specifications* Sections 1130 (Drums), 1135 (Cones), and 1180 (Skinny Drums) for additional requirements.

Place additional sets of three channelizing devices (Drums, Cones, or Skinny Drums) perpendicular to the edge of travelway on 100 to 500 ft. centers, as directed by the Engineer, when unopened lanes are closed to traffic.

Place Type III Barricades with "ROAD CLOSED" sign R11-2 attached, of sufficient length to close the entire roadway.

Install black on orange "DIP" (W8-2) and/or "BUMP" (W8-1) signs in advance of the uneven area in accordance with Roadway Standard Drawing 1101.11, or as directed by the Engineer.

4.3. LAW ENFORCEMENT

Use uniformed Law Enforcement officers to control traffic at signalized intersections when the temporary traffic pattern cannot be controlled by the signal's normal operation.

4.4. PROJECT REQUIREMENTS

Failure to comply with the following requirements will result in a suspension of all other operations:

1. Prior to beginning work, the Contractor shall submit a written construction sequence for traffic control and construction lighting to the Engineer at the first pre-construction meeting and the sequence must be approved before closing a lane of traffic.
2. Obtain written approval of the Engineer before working in more than one location or setting up additional lane closures. The maximum length of any one lane closure is 1 mile unless otherwise directed by the Engineer.
3. The Contractor shall not close or narrow any through lanes of main arterial roads during daytime hours (7:00 AM to 7:00 PM). The Contractor shall not close or narrow any through lanes of secondary roads or turn lanes on main arterial roads during peak period hours (7:00 AM to 9:00 AM and 4:00 PM to 7:00 PM). The Contractor shall not close or narrow any through lanes or

turn lanes of any roadways in the vicinity of schools while in session between the hours of 7:00 AM to 9:00 AM and 3:00 PM to 7:00 PM.

4. Contractor shall conduct operations in an order such that water does not accumulate.
5. The Contractor on this and any adjacent projects, or subcontractors working within this project shall coordinate lane closure location, type, and direction with the Engineer to best maintain lane continuity through the limits of this and adjacent projects.
6. Operate paving equipment and conduct paving operations in the same direction as the flow of traffic unless the operation is protected by barrier or guardrail or as directed by the Engineer. Maintain vehicular access in accordance with Section 1101-05 of the *2018 Standard Specifications*.
7. Provide appropriate construction lighting in accordance with Section 1413 of the *2018 Standard Specifications*.

4.5. MEASUREMENT AND PAYMENT

Law Enforcement will be measured and paid in accordance with Section 1190-3.

Temporary Traffic Control (Lump Sum) shall include but not be limited to providing Signs (portable, stationary, and/or barricade mounted), including detour signing, Truck Mounted Attenuators (TMA), Portable Changeable Message Signs (PCMS), Flashing Arrow Boards (FAB), Pilot Vehicle, Flaggers, Cones, Skinny Drums and Drums as shown in the applicable Roadway Standard Drawings and all labor, tools, equipment and incidentals necessary to furnish, install, maintain and remove traffic control devices when no longer required.

Temporary Traffic Control (Lump Sum) does not include Portable Concrete Barrier, Waterfilled Barrier, Temporary Crash Cushions, Digital Speed Limit Signs, Sequential Flashing Lights, or Presence Lights as these devices are beyond the scope of this provision.

Payment for *Temporary Traffic Control (Lump Sum)* will be made on the following schedule:

- (A) 70% of the unit bid price upon starting the project
- (B) 20% of the unit bid price when the project is 50% complete
- (C) 10% of the unit bid price when the project is 100% complete and all traffic control devices have been removed from the project.

Payment will be made under:

Pay Item	Pay Unit
Temporary Traffic Control.....	Lump Sum

5. SIGNAL HEADS

5.1. MATERIALS

A. General:

Fabricate vehicle signal head housings and end caps from die-cast aluminum. Fabricate 16-inch pedestrian signal head housings and end caps from die-cast aluminum. Provide visor mounting screws, door latches, and hinge pins fabricated from stainless steel. Provide interior screws, fasteners, and metal parts fabricated from stainless steel.

Fabricate tunnel and traditional visors from sheet aluminum.

Paint all surfaces inside and outside of signal housings and doors. Paint outside surfaces of tunnel and traditional visors, wire outlet bodies, wire entrance fitting brackets and end caps when supplied as components of messenger cable mounting assemblies, pole and pedestal mounting assemblies, and pedestrian pushbutton housings. Have electrostatically-applied, fused-polyester paint in highway yellow (Federal Standard 595C, Color Chip Number 13538) a minimum of 2.5 to 3.5 mils thick. Do not apply paint to the latching hardware, rigid vehicle signal head mounting brackets for mast-arm attachments, messenger cable hanger components or balance adjuster components.

Have the interior surfaces of tunnel and traditional visors painted an alkyd urea black synthetic baking enamel with a minimum gloss reflectance and meeting the requirements of MIL-E-10169, "Enamel Heat Resisting, Instrument Black."

Where required, provide polycarbonate signal heads and visors that comply with the provisions pertaining to the aluminum signal heads listed on the QPL with the following exceptions:

Fabricate signal head housings, end caps, and visors from virgin polycarbonate material. Provide UV stabilized polycarbonate plastic with a minimum thickness of 0.1 ± 0.01 inches that is highway yellow (Federal Standard 595C, Color Chip 13538). Ensure the color is incorporated into the plastic material before molding the signal head housings and end caps. Ensure the plastic formulation provides the following physical properties in the assembly (tests may be performed on separately molded specimens):

Test	Required	Method
Specific Gravity	1.17 minimum	ASTM D 792
Flammability	Self-extinguishing	ASTM D 635
Tensile Strength, yield, PSI	8500 minimum	ASTM D 638
Izod impact strength, ft-lb/in [notched, 1/8 inch]	12 minimum	ASTM D 256

For pole mounting, provide side of pole mounting assemblies with framework and all other hardware necessary to make complete, watertight connections of the signal heads to the poles and pedestals. Fabricate the mounting assemblies and frames from aluminum with all necessary hardware, screws, washers, etc. to be stainless steel. Provide mounting fittings that match the positive locking device on the signal head with the serrations integrally cast into the brackets. Provide upper and lower pole plates that have a 1 ¼-inch vertical conduit entrance hubs with the hubs capped on the lower plate and 1 ½-inch horizontal hubs. Ensure that the assemblies provide rigid attachments to poles and pedestals so as to allow no twisting or swaying of the signal heads. Ensure that all raceways are free of sharp edges and protrusions and can accommodate a minimum of ten Number 14 AWG conductors.

For pedestal mounting, provide a post-top slipfitter mounting assembly that matches the positive locking device on the signal head with serrations integrally cast into the slipfitter. Provide stainless steel hardware, screws, washers, etc. Provide a minimum of six 3/8 X 3/4-inch long square head bolts for attachment to pedestal. Provide a center post for multi-way slipfitters.

For light emitting diode (LED) traffic signal modules, provide the following requirements for inclusion on the Department's Qualified Products List for traffic signal equipment.

1. Sample submittal,

2. Third-party independent laboratory testing results for each submitted module with evidence of testing and conformance with all of the Design Qualification Testing specified in section 6.4 of each of the following Institute of Transportation Engineers (ITE) specifications:
 - Vehicle Traffic Control Signal Heads – Light Emitting Diode (LED) Circular Signal Supplement
 - Vehicle Traffic Control Signal Heads – Light Emitting Diode (LED) Vehicle Arrow Traffic Signal Supplement
 - Pedestrian Traffic Control Signal Indications –Light Emitting Diode (LED) Signal Modules.

(Note: The Department currently recognizes two approved independent testing laboratories. They are Intertek ETL Semko and Light Metrics, Incorporated with Garwood Laboratories. Independent laboratory tests from other laboratories may be considered as part of the QPL submittal at the discretion of the Department,

3. Evidence of conformance with the requirements of these specifications,
4. A manufacturer’s warranty statement in accordance with the required warranty, and
5. Submittal of manufacturer’s design and production documentation for the model, including but not limited to, electrical schematics, electronic component values, proprietary part numbers, bill of materials, and production electrical and photometric test parameters.
6. Evidence of approval of the product to bear the Intertek ETL Verified product label for LED traffic signal modules.

Ensure LED traffic signal modules meet the performance requirements for the minimum period of 15 years, provide a written warranty against defects in materials and workmanship for the modules for a period of 15 years after installation of the modules. During the warranty period, the manufacturer must provide new replacement modules within 45 days of receipt of modules that have failed at no cost to the State. Repaired or refurbished modules may not be used to fulfill the manufacturer’s warranty obligations. Provide manufacturer’s warranty documentation to the Department during evaluation of product for inclusion on Qualified Products List (QPL).

B. Vehicle Signal Heads:

Comply with the ITE standard “Vehicle Traffic Control Signal Heads”. Provide housings with provisions for attaching backplates.

Provide visors that are 10 inches in length for 12-inch vehicle signal heads.

Provide a termination block with one empty terminal for field wiring for each indication plus one empty terminal for the neutral conductor. Have all signal sections wired to the termination block. Provide barriers between the terminals that have terminal screws with a minimum Number 8 thread size and that will accommodate, and secure spade lugs sized for a Number 10 terminal screw.

Mount termination blocks in the yellow signal head sections on all in-line vehicle signal heads. Mount the termination block in the red section on five-section vehicle signal heads.

Furnish vehicle signal head interconnecting brackets. Provide one-piece aluminum brackets less than 4.5 inches in height and with no threaded pipe connections. Provide hand holes on the bottom of the brackets to aid in installing wires to the signal heads. Lower brackets that carry no wires and are used only for connecting the bottom signal sections together may be flat in construction.

For messenger cable mounting, provide messenger cable hangers, wire outlet bodies, balance adjusters, bottom caps, wire entrance fitting brackets, and all other hardware necessary to make

complete, watertight connections of the vehicle signal heads to the messenger cable. Fabricate messenger cable hanger components, wire outlet bodies and balance adjuster components from stainless steel or malleable iron galvanized in accordance with ASTM A153 (Class A) or ASTM A123. Provide serrated rings made of aluminum. Provide messenger cable hangers with U-bolt clamps. Fabricate washers, screws, hex-head bolts and associated nuts, clevis pins, cotter pins, U-bolt clamps and nuts from stainless steel.

For mast-arm mounting, provide rigid vehicle signal head mounting brackets and all other hardware necessary to make complete, watertight connections of the vehicle signal heads to the mast arms and to provide a means for vertically adjusting the vehicle signal heads to proper alignment. Fabricate the mounting assemblies from aluminum, and provide serrated rings made of aluminum. Provide stainless steel cable attachment assemblies to secure the brackets to the mast arms. Ensure all fastening hardware and fasteners are fabricated from stainless steel.

Provide LED vehicular traffic signal modules (hereafter referred to as modules) that consist of an assembly that uses LEDs as the light source in lieu of an incandescent lamp for use in traffic signal sections. Use LEDs that are aluminum indium gallium phosphorus (AlInGaP) technology for red and yellow indications and indium gallium nitride (InGaN) for green indications. Install the ultra-bright type LEDs that are rated for 100,000 hours of continuous operation from -40°F to +165°F. Design modules to have a minimum useful life of 15 years and to meet all parameters of this specification during this period of useful life.

For the modules, provide spade terminals crimped to the lead wires and sized for a #10 screw connection to the existing terminal block in a standard signal head. Do not provide other types of crimped terminals with a spade adapter.

Ensure the power supply is integral to the module assembly. On the back of the module, permanently mark the date of manufacture (month & year) or some other method of identifying date of manufacture.

Tint the red, yellow, and green lenses to correspond with the wavelength (chromaticity) of the LED. Transparent tinting films are unacceptable. Provide a lens that is integral to the unit with a smooth outer surface.

1. LED Circular Signal Modules:

Provide modules in the following configurations: 12-inch circular sections. All makes and models of LED modules purchased for use on the State Highway System shall appear on the current NCDOT Traffic Signal Qualified Products List (QPL).

Provide the manufacturer's model number and the product number (assigned by the Department) for each module that appears on the 2018 or most recent Qualified Products List. In addition, provide manufacturer's certification in accordance with Article 106-3 of the *Standard Specifications*, that each module meets or exceeds the ITE "Vehicle Traffic Control Signal Heads – Light Emitting Diode (LED) Circular Signal Supplement" dated June 27, 2005 (hereafter referred to as VTCSH Circular Supplement) and other requirements stated in this specification.

Provide modules that meet the following requirements when tested under the procedures outlined in the VTCSH Circular Supplement:

Module Type	Max. Wattage at 165° F	Nominal Wattage at 77° F
12-inch red circular	17	11
12-inch green circular	15	15

For yellow circular signal modules, provide modules tested under the procedures outlined in the VTCSH Circular Supplement to ensure power required at 77° F is 22 Watts or less for the 12-inch circular module.

Note: Use a wattmeter having an accuracy of $\pm 1\%$ to measure the nominal wattage and maximum wattage of a circular traffic signal module. Power may also be derived from voltage, current and power factor measurements.

2. LED Arrow Signal Modules

Provide 12-inch omnidirectional arrow signal modules. All makes and models of LED modules purchased for use on the State Highway System shall appear on the current NCDOT Traffic Signal Qualified Products List (QPL).

Provide the manufacturer's model number and the product number (assigned by the Department) for each module that appears on the 2018 or most recent Qualified Products List. In addition, provide manufacturer's certification in accordance with Article 106-3 of the *Standard Specifications*, that each module meets or exceeds the requirements for 12-inch omnidirectional modules specified in the ITE "Vehicle Traffic Control Signal Heads – Light Emitting Diode (LED) Vehicle Arrow Traffic Signal Supplement" dated July 1, 2007 (hereafter referred to as VTCSH Arrow Supplement) and other requirements stated in this specification.

Provide modules that meet the following requirements when tested under the procedures outlined in the VTCSH Arrow Supplement:

Module Type	Max. Wattage at 165° F	Nominal Wattage at 77° F
12-inch red arrow	12	9
12-inch green arrow	11	11

For yellow arrow signal modules, provide modules tested under the procedures outlined in the VTCSH Arrow Supplement to ensure power required at 77° F is 12 Watts or less.

Note: Use a wattmeter having an accuracy of $\pm 1\%$ to measure the nominal wattage and maximum wattage of an arrow traffic signal module. Power may also be derived from voltage, current and power factor measurements.

3. LED Bi-Modal Green-Yellow Arrow Signal Modules

Provide 12-inch omnidirectional bi-modal arrow signal modules. Ensure both green and yellow arrow indications are in each module with a clear lens that is integral to the unit. Ensure both indications display an incandescent style look.

Modules are not required to be listed on the ITS and Signals Qualified Products List. Ensure that both indications along with the module meet or exceed the requirements in sections 1, 2, 3, 4 and 5 of the VTCSH Arrow Supplement and other requirements stated in this specification.

Provide modules that meet the following requirements when tested under the procedures outlined in the VTCSH Arrow Supplement:

Arrow Type	Nominal Wattage at 77° F
12-inch yellow arrow	12
12-inch green arrow	11

Note: Use a wattmeter having an accuracy of $\pm 1\%$ to measure the nominal wattage and maximum wattage of a circular traffic signal module. Power may also be derived from voltage, current and power factor measurements.

C. Pedestrian Signal Heads:

Provide pedestrian signal heads with international symbols that meet the MUTCD. Do not provide letter indications.

Comply with the ITE standard for “Pedestrian Traffic Control Signal Indications” and the following sections of the ITE standard for “Vehicle Traffic Control Signal Heads” in effect on the date of advertisement:

- Section 3.00 - “Physical and Mechanical Requirements”
- Section 4.01 - “Housing, Door, and Visor: General”
- Section 4.04 - “Housing, Door, and Visor: Materials and Fabrication”
- Section 7.00 - “Exterior Finish”

Provide a double-row termination block with three empty terminals and number 10 screws for field wiring. Provide barriers between the terminals that accommodate a spade lug sized for number 10 terminal screws. Mount the termination block in the hand section. Wire all signal sections to the terminal block.

Where required by the plans, provide 16-inch pedestrian signal heads with traditional three-sided, rectangular visors, 6 inches long.

Provide 2-inch diameter pedestrian push-buttons with weather-tight housings fabricated from die-cast aluminum and threading in compliance with the NEC for rigid metal conduit. Provide a weep hole in the housing bottom and ensure that the unit is vandal resistant.

Provide push-button housings that are suitable for mounting on flat or curved surfaces and that will accept 1/2-inch conduit installed in the top. Provide units that have a heavy duty push-button assembly with a sturdy, momentary, normally-open switch. Have contacts that are electrically insulated from the housing and push-button. Ensure that the push-buttons are rated for a minimum of 5 mA at 24 volts DC and 250 mA at 12 volts AC.

Provide standard R10-3 signs with mounting hardware that comply with the MUTCD in effect on the date of advertisement. Provide R10-3E signs for countdown pedestrian heads and R10-3B for non-countdown pedestrian heads.

Design the LED pedestrian traffic signal modules (hereafter referred to as modules) for installation into standard pedestrian traffic signal sections that do not contain the incandescent signal section reflector, lens, eggcrate visor, gasket, or socket. Provide modules that consist of an assembly that uses LEDs as the light source in lieu of an incandescent lamp. Use LEDs that are of the latest aluminum indium gallium phosphorus (AlInGaP) technology for the Portland Orange hand and countdown displays. Use LEDs that are of the latest indium gallium nitride (InGaN) technology for the Lunar White walking man displays. Install the ultra-bright type LEDs that are rated for 100,000 hours of continuous operation from -40°F to $+165^{\circ}\text{F}$. Design modules to have a minimum useful life of 60 months and to meet all parameters of this specification during this period of useful life.

Design all modules to operate using a standard 3 - wire field installation. Provide spade terminals crimped to the lead wires and sized for a #10 screw connection to the existing terminal

block in a standard pedestrian signal housing. Do not provide other types of crimped terminals with a spade adapter.

Ensure the power supply is integral to the module assembly. On the back of the module, permanently mark the date of manufacture (month & year) or some other method of identifying date of manufacture.

Provide modules in the following configuration: 16-inch displays which have the solid hand/walking man overlay on the left and the countdown on the right. All makes and models of LED modules purchased for use on the State Highway System shall appear on the current NCDOT Traffic Signal Qualified Products List (QPL).

Provide the manufacturer's model number and the product number (assigned by the Department) for each module that appears on the 2018 or most recent Qualified Products List. In addition, provide manufacturer's certification in accordance with Article 106-3 of the *Standard Specifications*, that each module meets or exceeds the ITE "Pedestrian Traffic Control Signal Indicators - Light Emitting Diode (LED) Signal Modules" dated August 04, 2010 (hereafter referred to as PTCSI Pedestrian Standard) and other requirements stated in this specification.

Provide modules that meet the following requirements when tested under the procedures outlined in the PTCSI Pedestrian Standard:

Module Type	Max. Wattage at 165° F	Nominal Wattage at 77° F
Hand Indication	16	13
Walking Man Indication	12	9
Countdown Indication	16	13

Note: Use a wattmeter having an accuracy of $\pm 1\%$ to measure the nominal wattage and maximum wattage of a circular traffic signal module. Power may also be derived from voltage, current and power factor measurements.

Provide module lens that is hard coated or otherwise made to comply with the material exposure and weathering effects requirements of the Society of Automotive Engineers (SAE) J576. Ensure all exposed components of the module are suitable for prolonged exposure to the environment, without appreciable degradation that would interfere with function or appearance.

Ensure the countdown display continuously monitors the traffic controller to automatically learn the pedestrian phase time and update for subsequent changes to the pedestrian phase time.

Ensure the countdown display begins normal operation upon the completion of the preemption sequence and no more than one pedestrian clearance cycle.

D. Signal Cable:

Furnish 16-4 and 16-7 signal cable that complies with IMSA specification 20-1 except provide the following conductor insulation colors:

- For 16-4 cable: white, yellow, red, and green
- For 16-7 cable: white, yellow, red, green, yellow with black stripe tracer, red with black stripe tracer, and green with black stripe tracer. Apply continuous stripe tracer on conductor insulation with a longitudinal or spiral pattern.

Provide a ripcord to allow the cable jacket to be opened without using a cutter. IMSA specification 19-1 will not be acceptable. Provide a cable jacket labeled with the IMSA specification number and provide conductors constructed of stranded copper.

E. Modify Existing Vehicle Signal Heads:

Where required by the plans to modify existing signal heads, remove existing LED signal module, and replace with new LED signal module.

6. CONTROLLERS WITH CABINETS**6.1. MATERIALS – GENERAL CABINETS**

Provide a moisture resistant coating on all circuit boards.

Provide one 20 mm diameter radial lead UL-recognized metal oxide varistor (MOV) between each load switch field terminal and equipment ground. Electrical performance is outlined below.

PROPERTIES OF MOV SURGE PROTECTOR	
Maximum Continuous Applied Voltage at 185° F	150 VAC (RMS) 200 VDC
Maximum Peak 8x20µs Current at 185° F	6500 A
Maximum Energy Rating at 185° F	80 J
Voltage Range 1 mA DC Test at 77° F	212-268 V
Max. Clamping Voltage 8x20µs, 100A at 77° F	395 V
Typical Capacitance (1 MHz) at 77° F	1600 pF

Provide a power line surge protector that is a two-stage device that will allow connection of the radio frequency interference filter between the stages of the device. Ensure that a maximum continuous current is at least 10A at 120V. Ensure that the device can withstand a minimum of 20 peak surge current occurrences at 20,000A for an 8x20 microsecond waveform. Provide a maximum clamp voltage of 395V at 20,000A with a nominal series inductance of 200µh. Ensure that the voltage does not exceed 395V. Provide devices that comply with the following:

Frequency (Hz)	Minimum Insertion Loss (dB)
60	0
10,000	30
50,000	55
100,000	50
500,000	50
2,000,000	60
5,000,000	40
10,000,000	20
20,000,000	25

6.2. MATERIALS – TYPE 170E CABINETS

A. Type 170 E Cabinets General:

Conform to the city of Los Angeles' Specification No. 54-053-08, *Traffic Signal Cabinet Assembly Specification* (dated July 2008), except as required herein.

Furnish model 336S pole mounted cabinets configured for 8 vehicle phases, 4 pedestrian phases, and 6 overlaps. Do not reassign load switches to accommodate overlaps unless shown on electrical details. Provide 336S pole mounted cabinets that are 46" high with 40" high internal rack assemblies.

Furnish model 332 base mounted cabinets configured for 8 vehicle phases, 4 pedestrian phases, and 6 overlaps. When overlaps are required, provide auxiliary output files for the overlaps. Do not reassign load switches to accommodate overlaps unless shown on electrical details.

Provide model 200 load switches, model 222 loop detector sensors, model 252 AC isolators, and model 242 DC isolators according to the electrical details. As a minimum, provide one (1) model 2018 conflict monitor, one (1) model 206L power supply unit, two (2) model 204 flashers, one (1) DC isolator (located in slot I14), and four (4) model 430 flash transfer relays (provide seven (7) model 430 flash transfer relays if auxiliary output file is installed) with each cabinet.

B. Type 170 E Cabinet Electrical Requirements:

Provide a cabinet assembly designed to ensure that upon leaving any cabinet switch or conflict monitor initiated flashing operation, the controller starts up in the programmed start up phases and start up interval.

Furnish two sets of non-fading cabinet wiring diagrams and schematics in a paper envelope or container and placed in the cabinet drawer.

All AC+ power is subject to radio frequency signal suppression.

Provide surge suppression in the cabinet for each type of cabinet device. Provide surge protection for the full capacity of the cabinet input file. Provide surge suppression devices that operate properly over a temperature range of -40° F to +185° F. Ensure the surge suppression devices provide both common and differential modes of protection.

Provide a pluggable power line surge protector that is installed on the back of the PDA (power distribution assembly) chassis to filter and absorb power line noise and switching transients. Ensure the device incorporates LEDs for failure indication and provides a dry relay contact closure for the purpose of remote sensing. Ensure the device meets the following specifications:

Peak Surge Current (Single pulse, 8x20µs)	20,000A
Occurrences (8x20µs waveform)	10 minimum @ 20,000A
Maximum Clamp Voltage.....	395VAC
Operating Current.....	15 amps
Response Time.....	< 5 nanoseconds

Provide a loop surge suppressor for each set of loop terminals in the cabinet. Ensure the device meets the following specifications:

U-6022**TS-24****Wake County**

Peak Surge Current (6 times, 8x20 μ s)
 (Differential Mode)400A
 (Common Mode)1,000A
 Occurrences (8x20 μ s waveform)500 min @ 200A
 Maximum Clamp Voltage
 (Differential Mode @400A)35V
 (Common Mode @1,000A)35V
 Response Time..... < 5 nanoseconds
 Maximum Capacitance.....35 pF

Provide a data communications surge suppressor for each communications line entering or leaving the cabinet. Ensure the device meets the following specifications:

Peak Surge Current (Single pulse, 8x20 μ s)10,000A
 Occurrences (8x20 μ s waveform)100 min @ 2,000A
 Maximum Clamp Voltage..... Rated for equipment protected
 Response Time..... < 1 nanosecond
 Maximum Capacitance.....1,500 pF
 Maximum Series Resistance.....15 Ω

Provide a DC signal surge suppressor for each DC input channel in the cabinet. Ensure the device meets the following specifications:

Peak Surge Current (Single pulse, 8x20 μ s)10,000A
 Occurrences (8x20 μ s waveform)100 @ 2,000A
 Maximum Clamp Voltage.....30V
 Response Time..... < 1 nanosecond

Provide a 120 VAC signal surge suppressor for each AC+ interconnect signal input. Ensure the device meets the following specifications:

Peak Surge Current (Single pulse, 8x20 μ s)20,000A
 Maximum Clamp Voltage.....350VAC
 Response Time..... < 200 nanoseconds
 Discharge Voltage.....<200 Volts @ 1,000A
 Insulation Resistance..... \geq 100 M Ω

Provide conductors for surge protection wiring that are of sufficient size (ampacity) to withstand maximum overcurrents which could occur before protective device thresholds are attained and current flow is interrupted.

U-6022**TS-25****Wake County**

If additional surge protected power outlets are needed to accommodate fiber transceivers, modems, etc., install a UL listed, industrial, heavy-duty type power outlet strip with a minimum rating of 15 A / 125 VAC, 60 Hz. Provide a strip that has a minimum of 3 grounded outlets. Ensure the power outlet strip plugs into one of the controller unit receptacles located on the rear of the PDA. Ensure power outlet strip is mounted securely; provide strain relief if necessary.

Provide a door switch in the front and a door switch in the rear of the cabinet that will provide the controller unit with a Door Ajar alarm when either the front or the rear door is open. Ensure the door switches apply DC ground to the Input File when either the front door or the rear door is open.

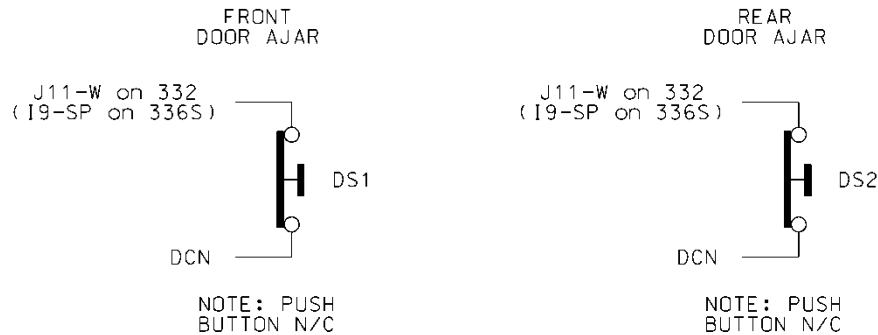

Furnish a fluorescent fixture in the rear across the top of the cabinet and another fluorescent fixture in the front across the top of the cabinet at a minimum. Ensure that the fixtures provide sufficient light to illuminate all terminals, labels, switches, and devices in the cabinet. Conveniently locate the fixtures so as not to interfere with a technician's ability to perform work on any devices or terminals in the cabinet. Provide a protective diffuser to cover exposed bulbs. Install 16-watt T-4 lamps in the fluorescent fixtures. Provide a door switch to provide power to each fixture when the respective door is open. Wire the fluorescent fixtures to the 15-amp ECB (equipment circuit breaker).

U-6022

TS-26

Wake County

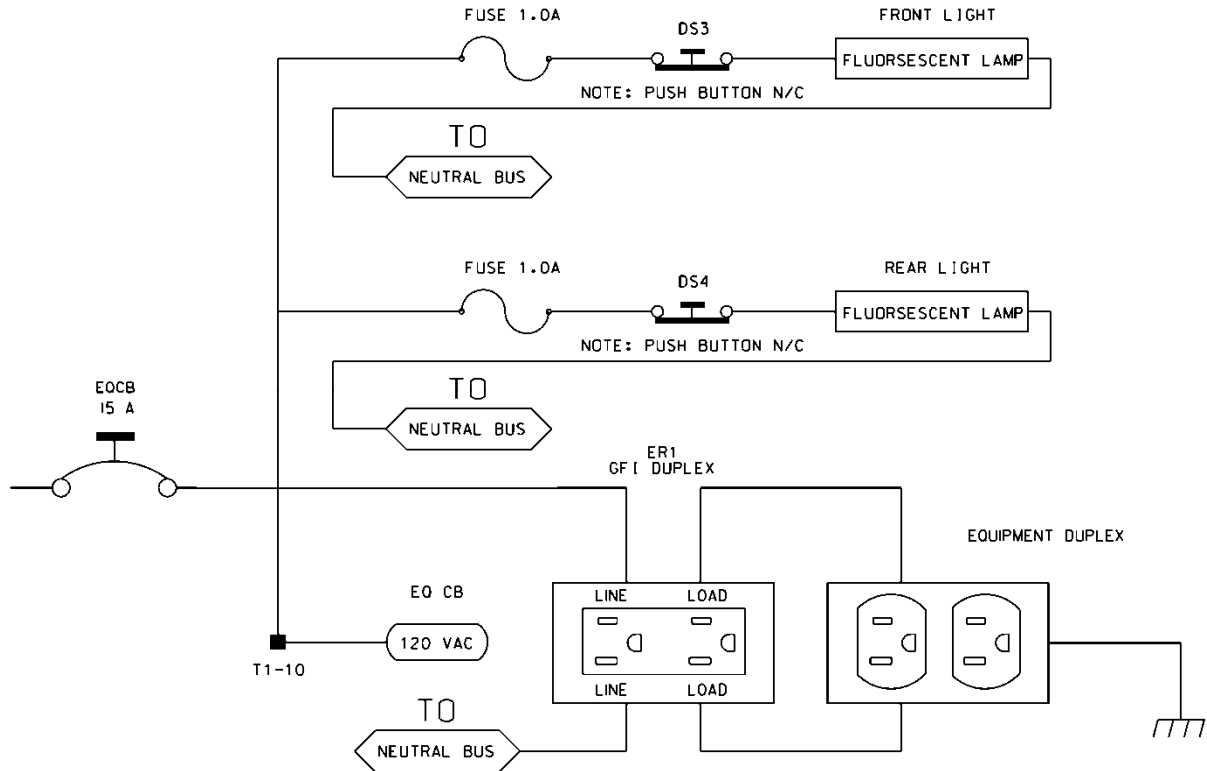

Furnish a police panel with a police panel door. For model 336S cabinets, mount the police panel on the rear door. Ensure that the police panel door permits access to the police panel when the main door is closed. Ensure that no rainwater can enter the cabinet even with the police panel door open. Provide a police panel door hinged on the right side as viewed from the front. Provide a police panel door lock that is keyed to a standard police/fire call box key. In addition to the requirements of LA Specification No. 54-053-08, provide the police panel with a toggle switch connected to switch the intersection operation between normal stop-and-go operation (AUTO) and manual operation (MANUAL). Ensure that manual control can be implemented using inputs and software such that the controller provides full programmed clearance times for the yellow clearance and red clearance for each phase while under manual control.

Provide a 1/4-inch locking phone jack in the police panel for a hand control to manually control the intersection. Provide sufficient room in the police panel for storage of a hand control and cord.

Ensure the 336S cabinet Input File is wired as follows:

U-6022

TS-27

Wake County

336S Cabinet														
Port-Bit/C-1 Pin Assignment														
Slot #	1	2	3	4	5	6	7	8	9	10	11	12	13	14
C-1 (Spares)	59	60	61	62	63	64	65	66	75	76	77	78	79	80
Port C-1	3-2 56	1-1 39	3-4 58	1-3 41	3-1 55	1-2 40	3-3 57	1-4 42	2-5 51	5-5 71	5-6 72	5-1 67	5-2 68	6-7 81
Port C-1	2-1 47	1-5 43	2-3 49	1-7 45	2-2 48	1-6 44	2-4 50	1-8 46	2-6 52	5-7 73	5-8 74	5-3 69	5-4 70	6-8 82

For model 332 base mounted cabinets, ensure terminals J14-E and J14-K are wired together on the rear of the Input File. Connect TB9-12 (J14 Common) on the Input Panel to T1-2 (AC-) on the rear of the PDA.

Provide detector test switches mounted at the top of the cabinet rack or other convenient location which may be used to place a call on each of eight phases based on the chart below. Provide three positions for each switch: On (place call), Off (normal detector operation), and Momentary On (place momentary call and return to normal detector operation after switch is released). Ensure that the switches are located such that the technician can read the controller display and observe the intersection.

Connect detector test switches for cabinets as follows:

336S Cabinet		332 Cabinet	
Detector Call Switches	Terminals	Detector Call Switches	Terminals
Phase 1	I1-F	Phase 1	I1-W
Phase 2	I2-F	Phase 2	I4-W
Phase 3	I3-F	Phase 3	I5-W
Phase 4	I4-F	Phase 4	I8-W
Phase 5	I5-F	Phase 5	J1-W
Phase 6	I6-F	Phase 6	J4-W
Phase 7	I7-F	Phase 7	J5-W
Phase 8	I8-F	Phase 8	J8-W

Provide the PCB 28/56 connector for the conflict monitor unit (CMU) with 28 independent contacts per side, dual-sided with 0.156-inch contact centers. Provide the PCB 28/56 connector contacts with solder eyelet terminations. Ensure all connections to the PCB 28/56 connector are soldered to the solder eyelet terminations.

Ensure that all cabinets have the CMU connector wired according to the 332 cabinet connector pin assignments (include all wires for auxiliary output file connection). Wire pins 13, 16, R, and U of the CMU connector to a separate 4 pin plug, P1, as shown below. Provide a second plug, P2, which will mate with P1 and is wired to the auxiliary output file as shown below. Provide an additional plug, P3, which will mate with P1 and is wired to the pedestrian yellow circuits as shown

U-6022

TS-28

Wake County

below. When no auxiliary output file is installed in the cabinet, provide wires for the green and yellow inputs for channels 11, 12, 17, and 18, the red inputs for channels 17 and 18, and the wires for the P2 plug. Terminate the two-foot wires with ring type lugs, insulated, and bundled for optional use.

PIN	P1		P2		P3	
	FUNCTION	CONN TO	FUNCTION	CONN TO	FUNCTION	CONN TO
1	CH-9G	CMU-13	OLA-GRN	A123	2P-YEL	114
2	CH-9Y	CMU-16	OLA-YEL	A122	4P-YEL	105
3	CH-10G	CMU-R	OLB-GRN	A126	6P-YEL	120
4	CH-10Y	CMU-U	OLB-YEL	A125	8P-YEL	111

Do not provide the P20 terminal assembly (red monitor board) or red interface ribbon cable as specified in LA Specification No. 54-053-08.

Provide a P20 connector that mates with and is compatible with the red interface connector mounted on the front of the conflict monitor. Ensure that the P20 connector and the red interface connector on the conflict monitor are center polarized to ensure proper connection. Ensure that removal of the P20 connector will cause the conflict monitor to recognize a latching fault condition and place the cabinet into flashing operation.

Wire the P20 connector to the output file and auxiliary output file using 22 AWG stranded wires. Ensure the length of these wires is a minimum of 42 inches in length. Provide a durable braided sleeve around the wires to organize and protect the wires.

Wire the P20 connector to the traffic signal red displays to provide inputs to the conflict monitor as shown below. Ensure the pedestrian Don't Walk circuits are wired to channels 13 through 16 of the P20 connector. When no auxiliary output file is installed in the cabinet, provide wires for channels 9 through 12 reds. Provide a wire for special function 1. Terminate the unused wires with ring type lugs, insulated, and bundled for optional use.

P20 Connector					
PIN	FUNCTION	CONN TO	PIN	FUNCTION	CONN TO
1	Channel 15 Red	119	2	Channel 16 Red	110
3	Channel 14 Red	104	4	Chassis GND	01-9
5	Channel 13 Red	113	6	N/C	
7	Channel 12 Red	AUX 101	8	Spec Function 1	
9	Channel 10 Red	AUX 124	10	Channel 11 Red	AUX 114
11	Channel 9 Red	AUX 121	12	Channel 8 Red	107
13	Channel 7 Red	122	14	Channel 6 Red	134

U-6022

TS-29

Wake County

15	Channel 5 Red	131	16	Channel 4 Red	101
17	Channel 3 Red	116	18	Channel 2 Red	128
19	Channel 1 Red	125	20	Red Enable	01-14

Ensure the controller unit outputs to the auxiliary output file are pre-wired to the C5 connector. When no auxiliary output file is installed in the cabinet, connect the C5 connector to a storage socket located on the Input Panel or on the rear of the PDA.

Do not wire pin 12 of the load switch sockets.

In addition to the requirements of LA Specification No. 54-053-08, ensure relay K1 on the Power Distribution Assembly (PDA) is a four-pole relay and K2 on the PDA is a two-pole relay.

Provide a two pole, ganged circuit breaker for the flash bus circuit. Ensure the flash bus circuit breaker is an inverse time circuit breaker rated for 10 amps at 120 VAC with a minimum of 10,000 RMS symmetrical amperes short circuit current rating. Do not provide the auxiliary switch feature on the flash bus circuit breaker. Ensure the ganged flash bus circuit breaker is certified by the circuit breaker manufacturer to provide gang tripping operation.

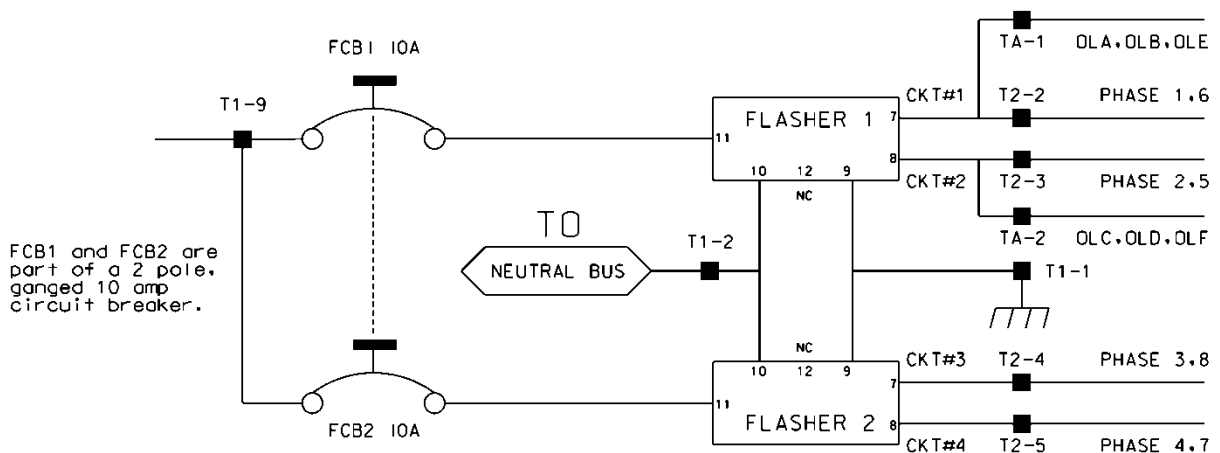

Ensure auxiliary output files are wired as follows:

U-6022

TS-30

Wake County

AUXILIARY OUTPUT FILE TERMINAL BLOCK TA ASSIGNMENTS	
POSITION	FUNCTION
1	Flasher Unit #1, Circuit 1/FTR1 (OLA, OLB)/FTR3 (OLE)
2	Flasher Unit #1, Circuit 2/FTR2 (OLC, OLD)/FTR3 (OLF)
3	Flash Transfer Relay Coils
4	AC -
5	Power Circuit 5
6	Power Circuit 5
7	Equipment Ground Bus
8	NC

Provide four spare load resistors mounted in each cabinet. Ensure each load resistor is rated as shown in the table below. Wire one side of each load resistor to AC-. Connect the other side of each resistor to a separate terminal on a four (4) position terminal block. Mount the load resistors and terminal block either inside the back of Output File No. 1 or on the upper area of the Service Panel.

ACCEPTABLE LOAD RESISTOR VALUES	
VALUE (ohms)	WATTAGE
1.5K – 1.9 K	25W (min)
2.0K – 3.0K	10W (min)

Provide Model 200 load switches, Model 204 flashers, Model 242 DC isolators, Model 252 AC isolators, and Model 206L power supply units that conform to CALTRANS' "Transportation Electrical Equipment Specifications" dated March 12, 2009, with Erratum 1.

C. Type 170 E Cabinet Physical Requirements:

Do not mold, cast, or scribe the name "City of Los Angeles" on the outside of the cabinet door as specified in LA Specification No. 54-053-08. Do not provide a Communications Terminal Panel as specified in LA Specification No. 54-053-08. Do not provide terminal block TBB on the Service Panel. Do not provide Cabinet Verification Test Program software or associated test jigs as specified in LA Specification No. 54-053-08.

Furnish unpainted, natural, aluminum cabinet shells. Ensure that all non-aluminum hardware on the cabinet is stainless steel or a Department approved non-corrosive alternate.

Ensure the lifting eyes, gasket channels, police panel, and all supports welded to the enclosure and doors are fabricated from 0.125-inch minimum thickness aluminum sheet and meet the same standards as the cabinet and doors.

U-6022**TS-31****Wake County**

Provide front and rear doors with latching handles that allow padlocking in the closed position. Furnish 0.75-inch minimum diameter stainless steel handles with a minimum 0.5 inch shank. Place the padlocking attachment at 4.0 inches from the handle shank center to clear the lock and key. Provide an additional 4.0 inches minimum gripping length.

Provide Corbin #2 locks on the front and rear doors. Provide one (1) Corbin #2 and one (1) police master key with each cabinet. Ensure main door locks allow removal of keys in the locked position only.

Provide a surge protection panel with 16 loop surge protection devices and designed to allow sufficient free space for wire connection/disconnection and surge protection device replacement. For model 332 cabinets, provide an additional 20 loop surge protection devices. Provide an additional two AC+ interconnect surge devices to protect one slot and eight DC surge protection devices to protect four slots. Provide no protection devices on slot I14.

For pole mounted cabinets, mount surge protection devices for the AC+ interconnect inputs, inductive loop detector inputs, and low voltage DC inputs on a swing down panel assembly fabricated from sturdy aluminum. Attach the swing down panel to the bottom rear cabinet rack assembly using thumb screws. Ensure the swing down panel allows for easy removal of the input file without removing the surge protection panel assembly or its parts. Have the surge protection devices mounted horizontally on the panel and soldered to the feed through terminals of four 14 position terminal blocks with #8 screws mounted on the other side. Ensure the top row of terminals is connected to the upper slots and the bottom row of terminals is connected to the bottom slots. Provide a 15-position copper equipment ground bus attached to the field terminal side (outside) of the swing down panel for termination of loop lead-in shield grounds. Ensure that a Number 4 AWG green wire connects the surge protection panel assembly ground bus to the main cabinet equipment ground.

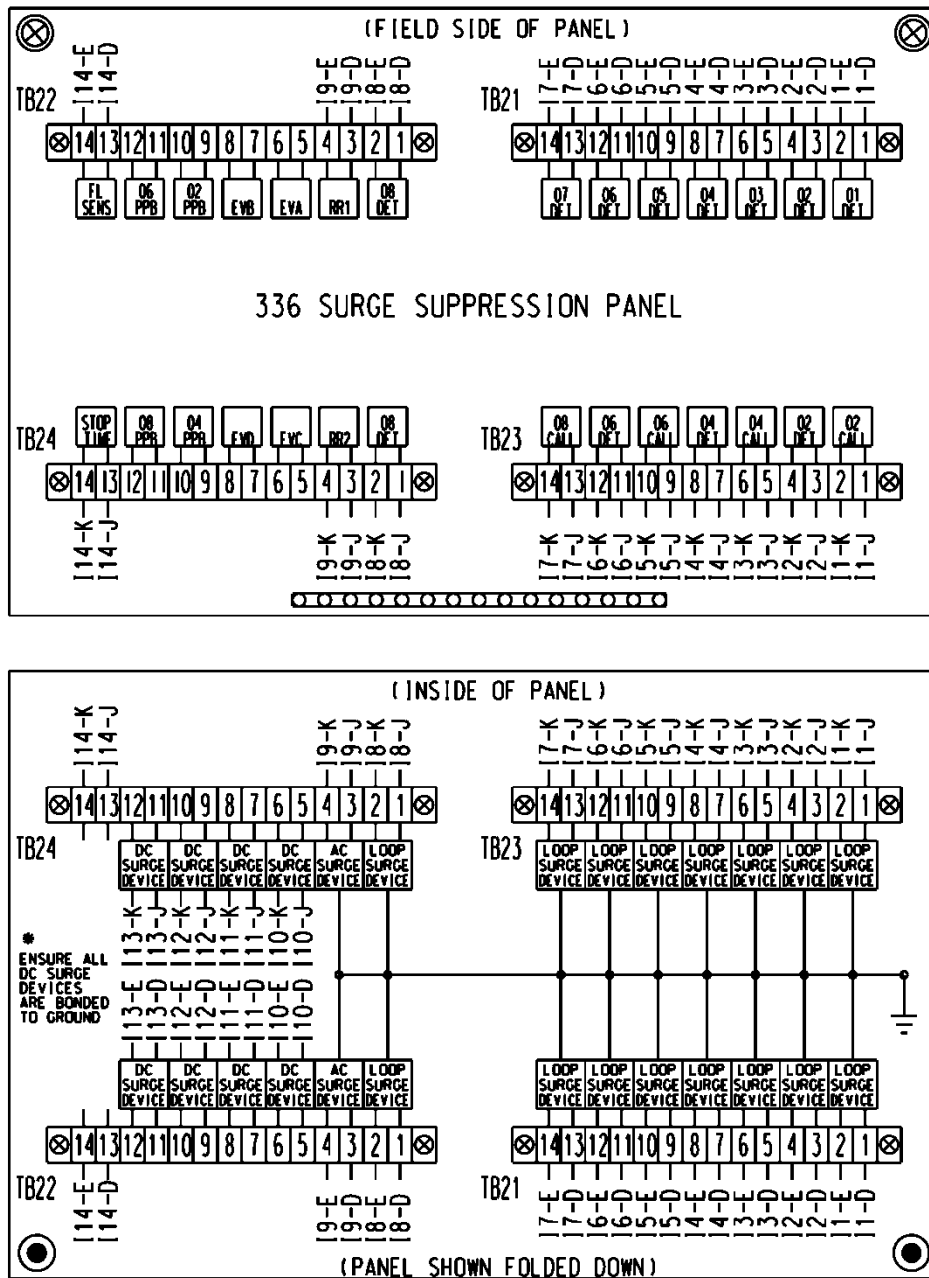

For base mounted cabinets, mount surge protection panels on the left side of the cabinet as viewed from the rear. Attach each panel to the cabinet rack assembly using bolts and make it easily removable. Mount the surge protection devices in vertical rows on each panel and connect the devices to one side of 12 position, double row terminal blocks with #8 screws. For each surge protection panel, terminate all grounds from the surge protection devices on a copper equipment ground bus attached to the surge protection panel. Wire the terminals to the rear of a standard input file using spade lugs for input file protection.

Provide permanent labels that indicate the slot and the pins connected to each terminal that may be viewed from the rear cabinet door. Label and orient terminals so that each pair of inputs is next to each other. Indicate on the labeling the input file (I or J), the slot number (1-14) and the terminal pins of the input slots (either D & E for upper or J & K for lower).

Provide a minimum 14 x 16 inch pull out, hinged top shelf located immediately below controller mounting section of the cabinet. Ensure the shelf is designed to fully expose the table surface outside the controller at a height approximately even with the bottom of the controller. Ensure the shelf has a storage bin interior which is a minimum of 1 inch deep and approximately the same dimensions as the shelf. Provide an access to the storage area by lifting the hinged top of the shelf. Fabricate the shelf and slide from aluminum or stainless steel and ensure the assembly can support the 2070L controller plus 15 pounds of additional weight. Ensure shelf has a locking mechanism to secure it in the fully extended position and does not inhibit the removal of the 2070L controller or removal of cards inside the controller when fully extended. Provide a locking mechanism that is easily released when the shelf is to be returned to its non-use position directly under the controller.

D. Model 2018 Enhanced Conflict Monitor:

Furnish Model 2018 Enhanced Conflict Monitors that provide monitoring of 18 channels. Ensure each channel consists of a green, yellow, and red field signal input. Ensure that the conflict monitor meets or exceeds CALTRANS' Transportation Electrical Equipment Specifications dated March 12, 2009, with Erratum 1 (hereafter referred to as CALTRANS' 2009 TEES) for a model 210 monitor unit and other requirements stated in this specification.

Ensure the conflict monitor is provided with an 18-channel conflict programming card. Pin EE and Pin T of the conflict programming card shall be connected together. Pin 16 of the conflict programming card shall be floating. Ensure that the absence of the conflict programming card will cause the conflict monitor to trigger (enter into fault mode) and remain in the triggered state until the programming card is properly inserted, and the conflict monitor is reset.

Provide a conflict monitor that incorporates LED indicators into the front panel to dynamically display the status of the monitor under normal conditions and to provide a comprehensive review of field inputs with monitor status under fault conditions. Ensure that the monitor indicates the channels that were active during a conflict condition and the channels that experienced a failure for all other per channel fault conditions detected. Ensure that these indications and the status of each channel are retained until the Conflict Monitor is reset. Furnish LED indicators for the following:

- AC Power (Green LED indicator)
- VDC Failed (Red LED indicator)
- WDT Error (Red LED indicator)
- Conflict (Red LED indicator)
- Red Fail (Red LED indicator)
- Dual Indication (Red LED indicator)
- Yellow/Clearance Failure (Red LED indicator)
- PCA/PC Ajar (Red LED indicator)
- Monitor Fail/Diagnostic Failure (Red LED indicator)

- 54 Channel Status Indicators (1 Red, 1 Yellow, and 1 Green LED indicator for each of the 18 channels)

Provide a switch to set the Red Fail fault timing. Ensure that when the switch is in the ON position the Red Fail fault timing value is set to 1350 +/- 150 ms (2018 mode). Ensure that when the switch is in the OFF position the Red Fail fault timing value is set to 850 +/- 150 ms (210 mode).

Provide a switch to set the Watchdog fault timing. Ensure that when the switch is in the ON position the Watchdog fault timing value is set to 1.0 +/- 0.1 s (2018 mode). Ensure that when the switch is in the OFF position the Watchdog fault timing value is set to 1.5 +/- 0.1 s (210 mode).

Provide a jumper or switch to set the AC line brown-out levels. Ensure that when the jumper is present or the switch is in the ON position the AC line dropout voltage threshold is 98 +/- 2 Vrms, the AC line restore voltage threshold is 103 +/- 2 Vrms, and the AC line brown-out timing value is set to 400 +/- 50ms (2018 mode). Ensure that when the jumper is not present or the switch is in the OFF position the AC line dropout voltage threshold is 92 +/- 2 Vrms, the AC line restore voltage threshold is 98 +/- 2 Vrms, and the AC line brown-out timing value is set to 80 +/- 17 ms (210 mode).

Provide a jumper or switch that will enable and disable the Watchdog Latch function. Ensure that when the jumper is not present, or the switch is in the OFF position the Watchdog Latch function is disabled. In this mode of operation, a Watchdog fault will be reset following a power loss, brownout, or power interruption. Ensure that when the jumper is present, or the switch is in the ON position the Watchdog Latch function is enabled. In this mode of operation, a Watchdog fault will be retained until a Reset command is issued.

Provide a jumper that will reverse the active polarity for pin #EE (output relay common). Ensure that when the jumper is not present pin #EE (output relay common) will be considered 'Active' at a voltage greater than 70 Vrms and 'Not Active' at a voltage less than 50 Vrms (Caltrans mode). Ensure that when the jumper is present pin #EE (output relay common) will be considered 'Active' at a voltage less than 50 Vrms and 'Not Active' at a voltage greater than 70 Vrms (Failsafe mode).

In addition to the connectors required by CALTRANS' 2009 TEES, provide the conflict monitor with a red interface connector mounted on the front of the monitor. Ensure the connector is a 20 pin, right angle, center polarized, male connector with latching clip locks and polarizing keys. Ensure the right angle solder tails are designed for a 0.062" thick printed circuit board. Keying of the connector shall be between pins 3 and 5, and between 17 and 19. Ensure the connector has two rows of pins with the odd numbered pins on one row and the even pins on the other row. Ensure the connector pin row spacing is 0.10" and pitch is 0.10". Ensure the mating length of the connector pins is 0.24". Ensure the pins are finished with gold plating 30μ" thick.

U-6022

TS-35

Wake County

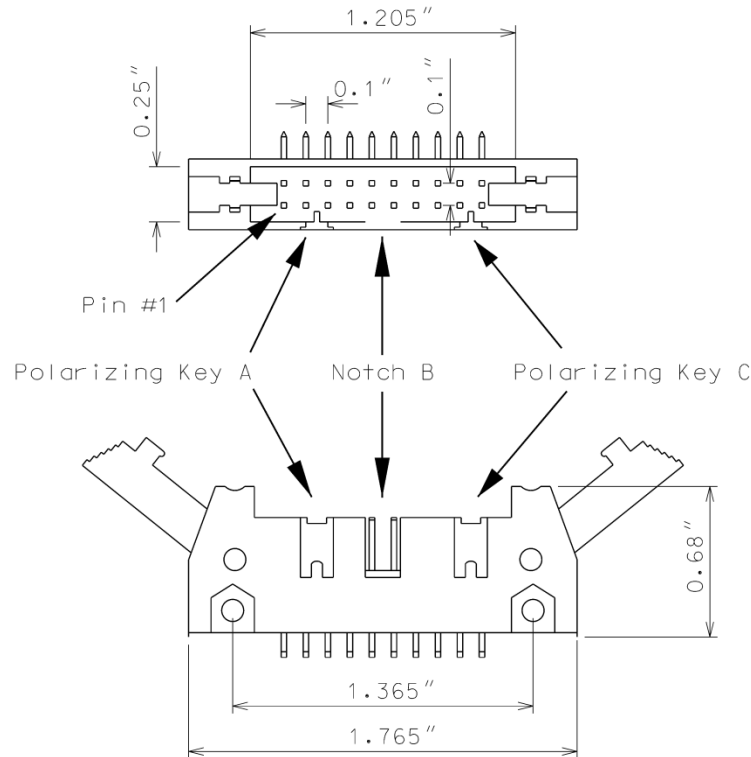

Ensure the red interface connector pins on the monitor have the following functions:

Pin #	Function	Pin #	Function
1	Channel 15 Red	2	Channel 16 Red
3	Channel 14 Red	4	Chassis Ground
5	Channel 13 Red	6	Special Function 2
7	Channel 12 Red	8	Special Function 1
9	Channel 10 Red	10	Channel 11 Red
11	Channel 9 Red	12	Channel 8 Red
13	Channel 7 Red	14	Channel 6 Red
15	Channel 5 Red	16	Channel 4 Red
17	Channel 3 Red	18	Channel 2 Red
19	Channel 1 Red	20	Red Enable

Ensure that removal of the P20 cable connector will cause the conflict monitor to recognize a latching fault condition and place the cabinet into flashing operation.

Provide Special Function 1 and Special Function 2 inputs to the unit which shall disable only Red Fail Monitoring when either input is sensed active. A Special Function input shall be sensed active when the input voltage exceeds 70 Vrms with a minimum duration of 550 ms. A Special Function input shall be sensed not active when the input voltage is less than 50 Vrms or the duration is less

than 250 ms. A Special Function input is undefined by these specifications and may or may not be sensed active when the input voltage is between 50 Vrms and 70 Vrms or the duration is between 250 ms and 550 ms.

Ensure the conflict monitor recognizes field signal inputs for each channel that meet the following requirements:

- consider a Red input greater than 70 Vrms and with a duration of at least 500 ms as an “on” condition;
- consider a Red input less than 50 Vrms or with a duration of less than 200 ms as an “off” condition (no valid signal);
- consider a Red input between 50 Vrms and 70 Vrms or with a duration between 200 ms and 500 ms to be undefined by these specifications;
- consider a Green or Yellow input greater than 25 Vrms and with a duration of at least 500 ms as an “on” condition;
- consider a Green or Yellow input less than 15 Vrms or with a duration of less than 200 ms as an “off” condition; and
- consider a Green or Yellow input between 15 Vrms and 25 Vrms or with a duration between 200 ms and 500 ms to be undefined by these specifications.

Provide a conflict monitor that recognizes the faults specified by CALTRANS’ 2009 TEES and the following additional faults. Ensure the conflict monitor will trigger upon detection of a fault and will remain in the triggered (in fault mode) state until the unit is reset at the front panel or through the external remote reset input for the following failures:

1. **Red Monitoring or Absence of Any Indication (Red Failure):** A condition in which no “on” voltage signal is detected on any of the green, yellow, or red inputs to a given monitor channel. If a signal is not detected on at least one input (R, Y, or G) of a conflict monitor channel for a period greater than 1000 ms when used with a 170 controller and 1500 ms when used with a 2070 controller, ensure monitor will trigger and put the intersection into flash. If the absence of any indication condition lasts less than 700 ms when used with a 170 controller and 1200 ms when used with a 2070 controller, ensure conflict monitor will not trigger. Red fail monitoring shall be enabled on a per channel basis by the use of switches located on the conflict monitor. Have red monitoring occur when all of the following input conditions are in effect:
 - a) Red Enable input to monitor is active (Red Enable voltages are “on” at greater than 70 Vrms, off at less than 50 Vrms, undefined between 50 and 70 Vrms), and
 - b) Neither Special Function 1 nor Special Function 2 inputs are active.
 - c) Pin #EE (output relay common) is not active
2. **Short/Missing Yellow Indication Fault (Clearance Error):** Yellow indication following a green is missing or shorter than 2.7 seconds (with ± 0.1 -second accuracy). If a channel fails to detect an “on” signal at the Yellow input for a minimum of 2.7 seconds (± 0.1 second) following the detection of an “on” signal at a Green input for that channel, ensure that the monitor triggers and generates a clearance/short yellow error fault indication. Short/missing

yellow (clearance) monitoring shall be enabled on a per channel basis by the use of switches located on the conflict monitor. This fault shall not occur when the channel is programmed for Yellow Inhibit, when the Red Enable signal is inactive or pin #EE (output relay common) is active.

3. **Dual Indications on the Same Channel:** In this condition, more than one indication (R, Y, G) is detected as “on” at the same time on the same channel. If dual indications are detected for a period greater than 500 ms, ensure that the conflict monitor triggers and displays the proper failure indication (Dual Ind fault). If this condition is detected for less than 200 ms, ensure that the monitor does not trigger. G-Y-R dual indication monitoring shall be enabled on a per channel basis by the use of switches located on the conflict monitor. G-Y dual indication monitoring shall be enabled for all channels by use of a switch located on the conflict monitor. This fault shall not occur when the Red Enable signal is inactive or pin #EE (output relay common) is active.
4. **Configuration Settings Change:** The configuration settings are comprised of (as a minimum) the permissive diode matrix, dual indication switches, yellow disable jumpers, any option switches, any option jumpers, and the Watchdog Enable switch. Ensure the conflict monitor compares the current configuration settings with the previous stored configuration settings on power-up, on reset, and periodically during operation. If any of the configuration settings are changed, ensure that the conflict monitor triggers and causes the program card indicator to flash. Ensure that configuration change faults are only reset by depressing and holding the front panel reset button for a minimum of three seconds. Ensure the external remote reset input does not reset configuration change faults.

Ensure the conflict monitor will trigger and the AC Power indicator will flash at a rate of $2 \text{ Hz} \pm 20\%$ with a 50% duty cycle when the AC Line voltage falls below the “drop-out” level. Ensure the conflict monitor will resume normal operation when the AC Line voltage returns above the “restore” level. Ensure the AC Power indicator will remain illuminated when the AC voltage returns above the “restore” level. Should an AC Line power interruption occur while the monitor is in the fault mode, then upon restoration of AC Line power, the monitor will remain in the fault mode and the correct fault and channel indicators will be displayed.

Provide a flash interval of at least 6 seconds and at most 10 seconds in duration following a power-up, an AC Line interruption, or a brownout restore. Ensure the conflict monitor will suspend all fault monitoring functions, close the Output relay contacts, and flash the AC indicator at a rate of $4 \text{ Hz} \pm 20\%$ with a 50% duty cycle during this interval. Ensure the termination of the flash interval after at least 6 seconds if the Watchdog input has made 5 transitions between the True and False state and the AC Line voltage is greater than the “restore” level. If the watchdog input has not made 5 transitions between the True and False state within 10 ± 0.5 seconds, the monitor shall enter a WDT error fault condition.

Ensure the conflict monitor will monitor an intersection with a minimum of four approaches using the four-section Flashing Yellow Arrow (FYA) vehicle traffic signal as outlined by the NCHRP 3-54 research project for protected-permissive left turn signal displays. Ensure the conflict monitor will operate in the FYA mode and FYAc (Compact) mode as specified below to monitor each channel pair for the following fault conditions: Conflict, Flash Rate Detection, Red Fail, Dual Indication, and

U-6022

TS-38

Wake County

Clearance. Provide a switch to select between the FYA mode and FYAc mode. Provide a switch to select each FYA phase movement for monitoring.

FYA mode

FYA Signal Head	Phase 1	Phase 3	Phase 5	Phase 7
Red Arrow	Channel 9 Red	Channel 10 Red	Channel 11 Red	Channel 12 Red
Yellow Arrow	Channel 9 Yellow	Channel 10 Yellow	Channel 11 Yellow	Channel 12 Yellow
Flashing Yellow Arrow	Channel 9 Green	Channel 10 Green	Channel 11 Green	Channel 12 Green
Green Arrow	Channel 1 Green	Channel 3 Green	Channel 5 Green	Channel 7 Green

FYAc mode

FYA Signal Head	Phase 1	Phase 3	Phase 5	Phase 7
Red Arrow	Channel 1 Red	Channel 3 Red	Channel 5 Red	Channel 7 Red
Yellow Arrow	Channel 1 Yellow	Channel 3 Yellow	Channel 5 Yellow	Channel 7 Yellow
Flashing Yellow Arrow	Channel 1 Green	Channel 3 Green	Channel 5 Green	Channel 7 Green
Green Arrow	Channel 9 Green	Channel 9 Yellow	Channel 10 Green	Channel 10 Yellow

If a FYA channel pair is enabled for FYA operation, the conflict monitor will monitor the FYA logical channel pair for the additional following conditions:

1. **Conflict:** Channel conflicts are detected based on the permissive programming jumpers on the program card. This operation remains unchanged from normal operation except for the solid Yellow arrow (FYA clearance) signal.
2. **Yellow Change Interval Conflict:** During the Yellow change interval of the Permissive Turn channel (flashing Yellow arrow) the conflict monitor shall verify that no conflicting channels to the solid Yellow arrow channel (clearance) are active. These conflicting channels shall be determined by the program card compatibility programming of the Permissive Turn channel (flashing Yellow arrow). During the Yellow change interval of the Protected Turn channel (solid Green arrow) the conflict monitor shall verify that no conflicting channels to the solid Yellow arrow channel (clearance) are active as determined by the program card compatibility programming of the Protected Turn channel (solid Green arrow).

3. **Flash Rate Detection:** The conflict monitor unit shall monitor for the absence of a valid flash rate for the Permissive turn channel (flashing Yellow arrow). If the Permissive turn channel (flashing Yellow arrow) is active for a period greater than 1600 milliseconds, ensure the conflict monitor triggers and puts the intersection into flash. If the Permissive turn channel (flashing Yellow arrow) is active for a period less than 1400 milliseconds, ensure the conflict monitor does not trigger. Ensure the conflict monitor will remain in the triggered (in fault mode) state until the unit is reset at the front panel or through the external remote reset input. Provide a jumper or switch that will enable and disable the Flash Rate Detection function. Ensure that when the jumper is not present, or the switch is in the OFF position the Flash Rate Detection function is enabled. Ensure that when the jumper is present, or the switch is in the ON position the Flash Rate Detection function is disabled.
4. **Red Monitoring or Absence of Any Indication (Red Failure):** The conflict monitor unit shall detect a red failure if there is an absence of voltage on all four of the inputs of a FYA channel pair (RA, YA, FYA, GA).
5. **Dual Indications on the Same Channel:** The conflict monitor unit shall detect a dual indication if two or more inputs of a FYA channel pair (RA, YA, FYA, GA) are “on” at the same time.
6. **Short/Missing Yellow Indication Fault (Clearance Error):** The conflict monitor unit shall monitor the solid Yellow arrow for a clearance fault when terminating both the Protected Turn channel (solid Green arrow) interval and the Permissive Turn channel (flashing Yellow arrow) interval.

Ensure that the conflict monitor will log at least nine of the most recent events detected by the monitor in non-volatile EEPROM memory (or equivalent). For each event, record at a minimum the time, date, type of event, status of each field signal indication with RMS voltage, and specific channels involved with the event. Ensure the conflict monitor will log the following events: monitor reset, configuration, previous fault, and AC line. Furnish the signal sequence log that shows all channel states (Greens, Yellows, and Reds) and the Red Enable State for a minimum of 2 seconds prior to the current fault trigger point. Ensure the display resolution of the inputs for the signal sequence log is not greater than 50 ms.

For conflict monitors used within an Ethernet communications system, provide a conflict monitor with an Ethernet 10/100 Mbps, RJ-45 port for data communication access to the monitor by a local notebook computer and remotely via a workstation or notebook computer device connected to the signal system local area network. The Ethernet port shall be electrically isolated from the conflict monitor’s electronics and shall provide a minimum of 1500 Vrms isolation. Integrate monitor with Ethernet network in cabinet. Provide software to retrieve the time and date from a network server in order to synchronize the on-board times between the conflict monitor and the controller. Furnish and install the following Windows based, graphic user interface software on workstations and notebook computers where the signal system client software is installed: 1) software to view and retrieve all event log information, 2) software that will search and display a list of conflict monitor IP addresses and IDs on the network, and 3) software to change the conflict monitor’s network parameters such as IP address and subnet mask.

For non-Ethernet connected monitors, provide a RS-232C/D compliant port (DB-9 female connector) on the front panel of the conflict monitor in order to provide communications from the conflict monitor to the 170/2070 controller or to a Department-furnished laptop computer. Electrically isolate the port interface electronics from all monitor electronics, excluding Chassis Ground. Ensure that the controller can receive all event log information through a controller

U-6022**TS-40****Wake County**

Asynchronous Communications Interface Adapter (Type 170E) or Async Serial Comm Module (2070). Furnish and connect a serial cable from the conflict monitor's DB-9 connector to Comm Port 1 of the 2070 controller. Ensure conflict monitor communicates with the controller. Provide a Windows based graphic user interface software to communicate directly through the same monitor RS-232C/D compliant port to retrieve and view all event log information to a Department-furnished laptop computer. The RS-232C/D compliant port on the monitor shall allow the monitor to function as a DCE device with pin connections as follows:

Conflict Monitor RS-232C/D (DB-9 Female) Pinout		
Pin Number	Function	I/O
1	DCD	O
2	TX Data	O
3	RX Data	I
4	DTR	I
5	Ground	-
6	DSR	O
7	CTS	I
8	RTS	O
9	NC	-

U-6022

TS-41

Wake County

MONITOR BOARD EDGE CONNECTOR

Pin #	Function (Back Side)	Pin #	Function (Component Side)
1	Channel 2 Green	A	Channel 2 Yellow
2	Channel 13 Green	B	Channel 6 Green
3	Channel 6 Yellow	C	Channel 15 Green
4	Channel 4 Green	D	Channel 4 Yellow
5	Channel 14 Green	E	Channel 8 Green
6	Channel 8 Yellow	F	Channel 16 Green
7	Channel 5 Green	H	Channel 5 Yellow
8	Channel 13 Yellow	J	Channel 1 Green
9	Channel 1 Yellow	K	Channel 15 Yellow
10	Channel 7 Green	L	Channel 7 Yellow
11	Channel 14 Yellow	M	Channel 3 Green
12	Channel 3 Yellow	N	Channel 16 Yellow
13	Channel 9 Green	P	Channel 17 Yellow
14	Channel 17 Green	R	Channel 10 Green
15	Channel 11 Yellow	S	Channel 11 Green
16	Channel 9 Yellow	T	Channel 18 Yellow
17	Channel 18 Green	U	Channel 10 Yellow
--		--	
18	Channel 12 Yellow	V	Channel 12 Green
19	Channel 17 Red	W	Channel 18 Red
20	Chassis Ground	X	Not Assigned
21	AC-	Y	DC Common
22	Watchdog Timer	Z	External Test Reset
23	+24VDC	AA	+24VDC
24	Tied to Pin 25	BB	Stop Time (Output)
25	Tied to Pin 24	CC	Not Assigned
26	Not Assigned	DD	Not Assigned
27	Relay Output, Side #3, N.O.	EE	Relay Output, Side #2, Common
28	Relay Output, Side #1, N.C.	FF	AC+

-- Slotted for keying between Pins 17/U and 18/V

U-6022

TS-42

Wake County

CONFLICT PROGRAM CARD PIN ASSIGNMENTS

Pin #	Function (Back Side)	Pin #	Function (Component Side)
1	Channel 2 Green	A	Channel 1 Green
2	Channel 3 Green	B	Channel 2 Green
3	Channel 4 Green	C	Channel 3 Green
4	Channel 5 Green	D	Channel 4 Green
5	Channel 6 Green	E	Channel 5 Green
6	Channel 7 Green	F	Channel 6 Green
7	Channel 8 Green	H	Channel 7 Green
8	Channel 9 Green	J	Channel 8 Green
9	Channel 10 Green	K	Channel 9 Green
10	Channel 11 Green	L	Channel 10 Green
11	Channel 12 Green	M	Channel 11 Green
12	Channel 13 Green	N	Channel 12 Green
13	Channel 14 Green	P	Channel 13 Green
14	Channel 15 Green	R	Channel 14 Green
15	Channel 16 Green	S	Channel 15 Green
16	N/C	T	PC AJAR
17	Channel 1 Yellow	U	Channel 9 Yellow
18	Channel 2 Yellow	V	Channel 10 Yellow
19	Channel 3 Yellow	W	Channel 11 Yellow
20	Channel 4 Yellow	X	Channel 12 Yellow
21	Channel 5 Yellow	Y	Channel 13 Yellow
22	Channel 6 Yellow	Z	Channel 14 Yellow
23	Channel 7 Yellow	AA	Channel 15 Yellow
24	Channel 8 Yellow	BB	Channel 16 Yellow
--		--	
25	Channel 17 Green	CC	Channel 17 Yellow
26	Channel 18 Green	DD	Channel 18 Yellow
27	Channel 16 Green	EE	PC AJAR (Program Card)
28	Yellow Inhibit Common	FF	Channel 17 Green

-- Slotted for keying between Pins 24/BB and 25/CC

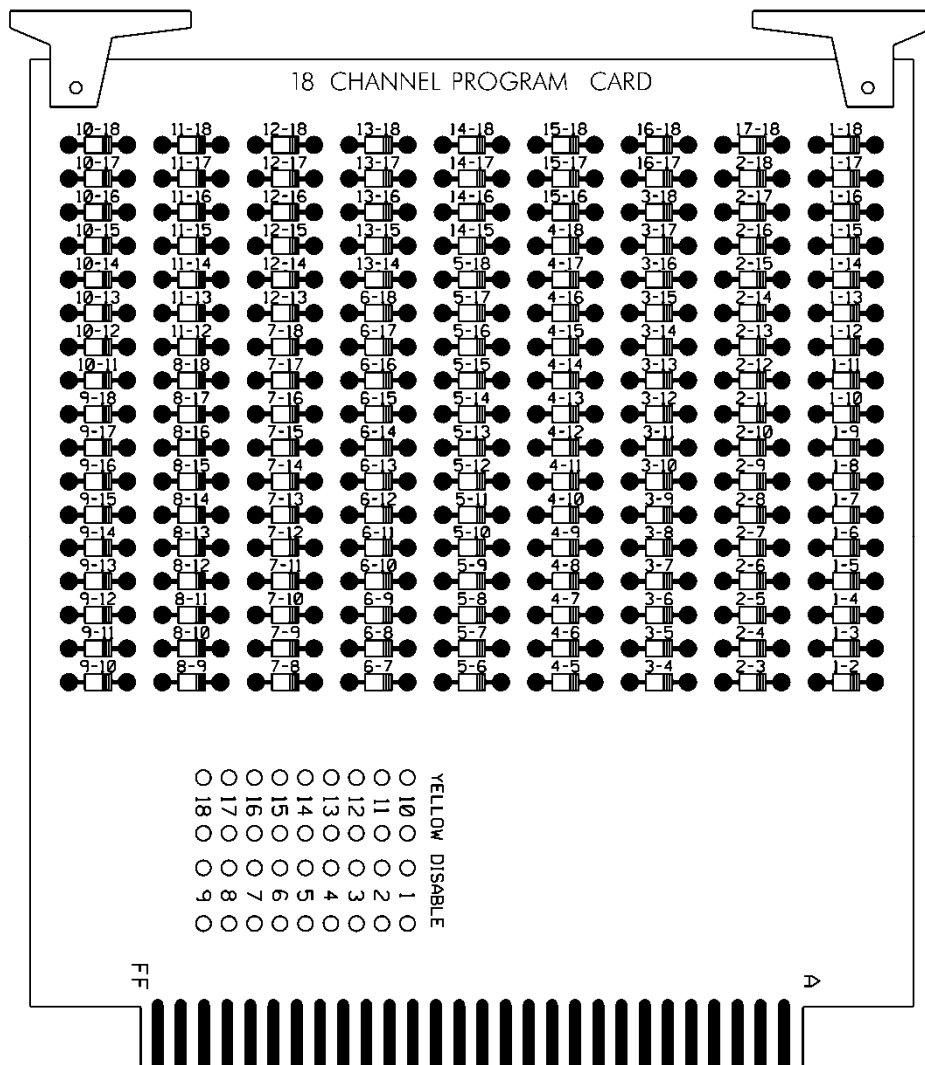

Figure 1

E. Preemption and Sign Control Box

Provide preemption and sign control box to operate in a Model 332 and Model 336S cabinet. Provide hardware to mount the box to the cage of the cabinet to ensure the front side is facing the opposite side of the cabinet. Furnish the material of the box from a durable finished metallic or thermoplastic case. Ensure the size of the box is not greater than 7(l) x 5(w) x 5(d) inches. Ensure that no modification is necessary to mount the box on the cabinet cage.

Provide the following components in the preemption and sign control box: relays, fuses, terminal blocks, MOVs, resistor, RC network, lamp, and push button switch.

Provide UL Listed or Recognized relay K1 as a DPDT enclosed relay (120 VAC, 60 Hz coil) with an 8-pin octal-style plug and associated octal base. Provide contact material made of AgCdO with a 10 amp, 240 VAC rating. Ensure the relay has a specified pickup voltage of 102 VAC.

U-6022**TS-44****Wake County**

Provide relay SSR1 as a Triac SPST normally open solid state relay that is rated for 120 VAC input and zero-crossing (resistive load) 25 amp @ 120 VAC output. Ensure the relay turns on at 90 Vrms within 10 ms and turns off at 10 Vrms within 40 ms. Ensure the relay has physical characteristics as shown in the wiring detail in Figure 1. Provide 4 terminal screws with saddle clamps.

Provide fuses F1 and F2 as a UL Listed ¼" x 1-1/4" glass tube rated at 250 volts with a 10kA interrupting rating. Ensure F1 non-delay (fast-acting) and F2 slow-blow (time-delay) fuses have a maximum opening times of 60 minutes and 120 seconds for currents of 135 and 200 percent of the ampere rating, respectively. Ensure F2 slow-blow (time-delay) fuses have a minimum opening times of 12 seconds at 200 percent of the ampere rating. Provide fuse holders that are UL Recognized panel-mounted holders rated 250V, 15 ampere minimum with bayonet-type knobs which accept ¼" x 1-1/4" glass tube fuses.

Provide terminal blocks that are rated for 300V and are made of electrical grade thermoplastic or thermosetting plastic. Ensure each terminal block is of closed back design and has recessed-screw terminals with molded barriers between terminals. Ensure each terminal block is labeled with a block designation. Ensure each terminal is labeled with the function and a number.

Provide 3/4-inch diameter radial lead UL-recognized metal oxide varistors (MOVs) that have electrical performance as outlined below.

PROPERTIES OF MOV SURGE PROTECTOR	
Maximum Continuous Applied Voltage at 185° F	150 VAC (RMS) 200 VDC
Maximum Peak 8x20µs Current at 185° F	6500 A
Maximum Energy Rating at 185° F	80 J
Voltage Range 1 mA DC Test at 77° F	212-268 V
Max. Clamping Voltage 8x20µs, 100A at 77° F	395 V
Typical Capacitance (1 MHz) at 77° F	1600 pF

Provide resistor R1 as a 2K ohm, 12 watt, wirewound resistor with tinned terminals and attaching leads. Ensure the resistor is spaced apart from surrounding wires.

Provide a LED or incandescent lamp that has a voltage rating of 120 VAC with a minimum life rating at 50,000 hours.

Wire the preemption and sign control box as shown in Figure 1.

RAILROAD PREEMPTION WIRING DETAIL

(wire as shown below)

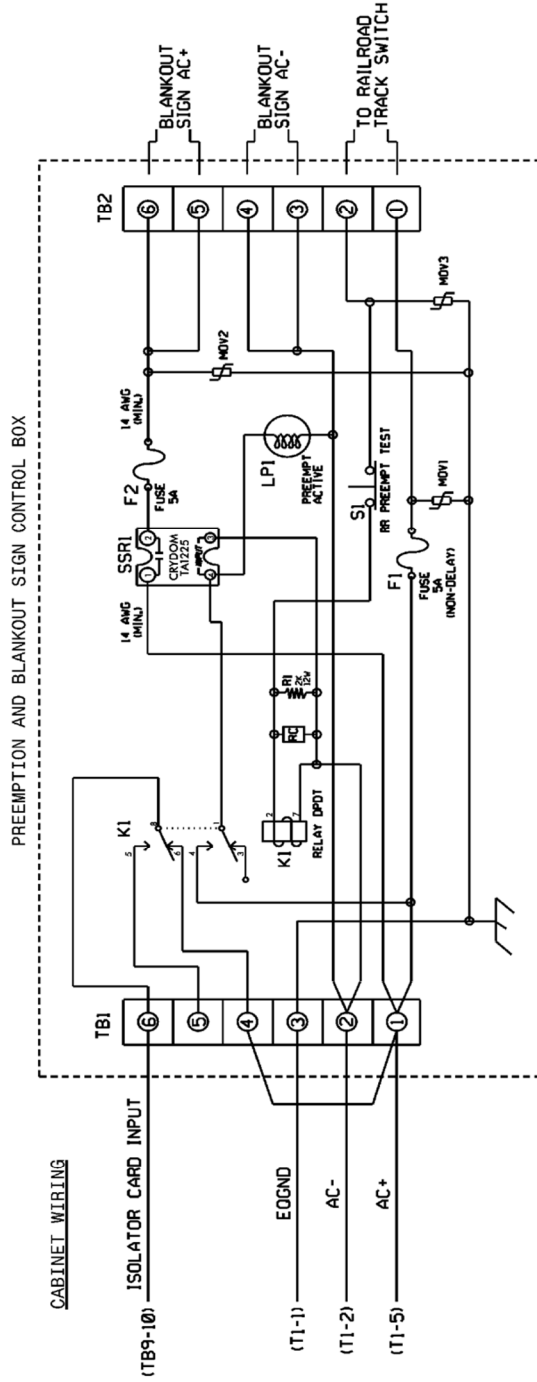

NOTES

1. RELAY K1 IS SHOWN IN THE ENERGIZED (PREEMPT NOT ACTIVE) NORMAL OPERATION STATE.
2. AC ISOLATOR CARD SHALL ACTIVATE PREEMPTION UPON REMOVAL OF AC+ FROM INPUT (AS SHOWN ABOVE). THIS IS ACCOMPLISHED BY SETTING TYPE 252 AC ISOLATOR CARD TO INVERTED OPERATION.

FRONT VIEW

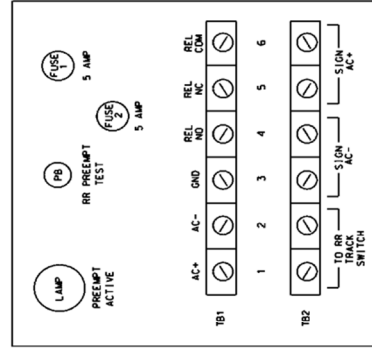

Figure 1

U-6022

TS-46

Wake County

6.3. MATERIALS – TYPE 170 DETECTOR SENSOR UNITS

Furnish detector sensor units that comply with Chapter 5 Section 1, “General Requirements,” and Chapter 5 Section 2, “Model 222 & 224 Loop Detector Sensor Unit Requirements,” of the CALTRANS “Transportation Electrical Equipment Specifications” dated March 12, 2009, with Erratum 1.

6.4. MATERIALS – TYPE 2070LX CONTROLLERS

Furnish model 2070LX controller units that conform to CALTRANS *Transportation Electrical Equipment Specifications* (TEES) (dated March 12, 2009, plus Errata 1 dated January 21, 2010, and Errata 2 dated December 5, 2014) except as required herein.

The Department will provide software at the beginning of the burning-in period. Contractor shall give 5 working days notice before needing software. Program software provided by the Department.

Provide model 2070LX controllers with Linux kernel 2.6.18 or higher and device drivers, composed of the unit chassis and at a minimum the following modules and assemblies:

- MODEL 2070-1C, CPU Module, Single Board, with 8Mb Datakey (blue in color)
- MODEL 2070-2E+, Field I/O Module (FI/O)
 - Note: Configure the Field I/O Module to disable both the External WDT Shunt/Toggle Switch and SP3 (SP3 active indicator is “off”)
- MODEL 2070-3B, Front Panel Module (FP), Display B (8x40)
- MODEL 2070-4A, Power Supply Module, 10 AMP

Provide a Board Support Package (BSP) to the state and to any specified applications software manufacturer when requested by the state to facilitate the porting of application software.

6.5. ADDITIONAL CONSTRUCTION METHODS

In addition to the construction methods in the 2018 *Standard Specifications*, install new controller and/or conflict monitor in existing signal cabinet as directed by the plans.

6.6. MEASUREMENT AND PAYMENT

Payment will be made under:

2070LX Controller will be measured and paid for as the actual number of controllers furnished, installed, and accepted.

No separate payment will be made for the conflict monitor or other equipment related to the controller or cabinet as this will be considered incidental to furnishing and installing the 2070LX controller.

Pay Item	Pay Unit
2070LX Controller	Each

U-6022

TS-47

Wake County

7. JUNCTION BOX MARKERS

7.1. DESCRIPTION

Furnish and install junction box markers with all necessary hardware and adhesives to warn of buried fiber-optic communications cable.

7.2. MATERIALS

Furnish durable, non-reflective junction box markers, also known as curb markers, fabricated from UV-resistant, non-metallic materials other than ceramic material, such as polyurethane or high impact polypropylene or other high impact plastic. Provide junction box markers that are designed for outdoor use, that are waterproof, that resist fading, that are temperature stable and that resist chemical and mechanical abrasion. Furnish junction box markers with a quick-setting adhesive designed for use with the junction box markers supplied and designed to permanently adhere junction box markers to Portland cement/concrete, steel, and cast iron as well as other non-porous hard surfaces. Do not provide markers that require intrusive fasteners to secure the marker to the surface. Do not provide adhesives that are not designed for use with the junction markers supplied. Provide junction box markers that do not require special tools such as torches, tamping machines or drills or hardware or special surface preparation for installation. Furnish junction box markers from a manufacturer that has been producing such junction box markers (i.e., curb markers) for a minimum of 10 consecutive years.

Order the junction box marker with the Division's Phone Number printed on the marker, hand written sharpie labeling is not acceptable. Consult with the Engineer to ensure the junction box labels are ordered with the correct Division phone number. Provide junction box markers that contain the text and symbols, text emphasis and text proportions depicted in the example format shown below.:

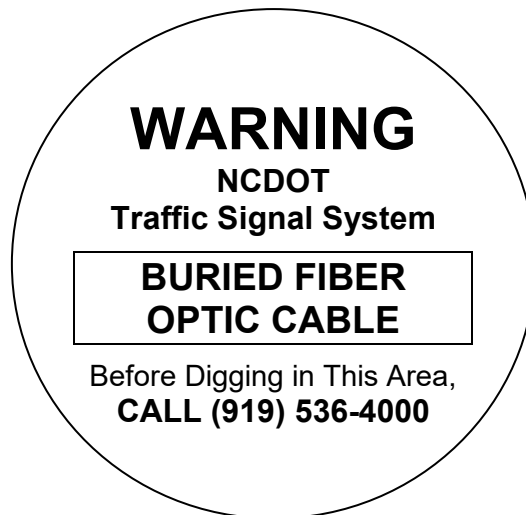

Overall Junction Box Marker Dimensions: 2.5" diameter

Text: Black

Background: Light Gray (to blend with concrete and granite surfaces)

Submit samples of proposed junction marker to the Engineer for approval before installation. In lieu of designing a custom junction box marker, the Contractor may submit for the Engineer's

U-6022

TS-48

Wake County

approval a stock/standard junction box marker format (i.e., off-the-shelf format) from the junction box marker manufacturer that differs from the example format proposed above but that still embodies the content and intent conveyed by the example format.

Have the junction box marker manufacturer provide a list of references along with contract information for at least five different municipal government agencies and/or state departments of transportation that have installed the proposed manufacturer’s markers and can attest to the performance of the manufacturer’s markers over a continuous period of no less than seven years. Submit these references to the Engineer for review in conjunction with submission of the sample.

7.3. CONSTRUCTION METHODS

Apply junction box markers to the surface of the junction box cover/lid on all new and/or existing junction boxes that are to be reused to house the fiber-optic communications cable. Additionally, at locations where a junction box is perpendicular to a raised curb place an additional junction box marker on the curb.

Clean surface to which the junction box marker will be applied. Make sure application surface is dry and free of any loose debris or cracks. Apply adhesive to back side of the junction box marker in accordance with manufacturer’s instructions. Apply additional adhesive when surface is uneven or textured to fill voids and assure secure adhesion. Apply the junction box marker to the application surface and press firmly. Ensure that entire edge around perimeter of marker is sealed to the application surface.

Position the marker in the approximate center of the junction box cover and orient the marker so that its text is parallel to long side of the cover. On curb sections install the marker on the flattest surface of the curb at a point that is perpendicular to the junction box.

Junction box markers are not required to be place on flat surfaces of the roadway where there is no curbing, unless required by the Engineer.

7.4. MEASUREMENT AND PAYMENT

Junction Box Marker will be measured and paid for as the actual number of junction box markers furnished, installed, and accepted.

No measurement will be made of junction box marker adhesive as this will be considered incidental to furnishing and installing the junction box marker.

Payment will be made under:

Pay Item	Pay Unit
Junction Box Marker.....	Each

8. HUB CABINET

8.1. DESCRIPTION

Furnish and install hub cabinet and all necessary hardware in accordance with the plans and specifications for terminating fiber-optic cable and housing and powering the hub switch. The Ethernet hub switch will be procured, configured, and installed by the Department. Request the hub switch from the Engineer a minimum of 120 days in advance of need. The Department will also procure and install an ISP circuit that will be located within the hub cabinet to establish communications between the hub switch and the STOC. Request the ISP circuit from the Engineer a

minimum of 120 days in advance of need and after the hub cabinet has been installed with functioning electrical service.

8.2. MATERIALS

Furnish Type 332 cabinet of sufficient size to accommodate the fiber-optic interconnect center, and hub switch. Provide sufficient size so that the equipment installed will not occupy more than 60 percent of the total cabinet volume.

8.3. ELECTRICAL

Provide a service panel assembly to function as the entry point for power filtering, transient suppression, and equipment grounding. Configure cabinet to accept 120 VAC from the service disconnect.

Provide circuit breakers that are UL listed and have an interrupt capacity of 5,000 amperes and insulation resistance of 100 M Ω at 500 VDC. Provide power distribution blocks that are suitable for use as power feed and as junction points for two and three wire circuits. Ensure that the line side of each block is capable of handling up to 2/0 AWG conductors. Ensure that the equipment ground wiring and terminal blocks are isolated from the line wiring by an insulation resistance of at least 10 M Ω when measured at the neutral.

Provide UL listed surge protection devices according to the UL 1449, 2nd edition standard that comply with the NEMA requirements as detailed in the NEMA LS 1 (1992) standard.

Provide branch circuits, surge protection devices, and grounding for the ITS device-connected load served by the cabinet, including ventilation fans, internal lights, electrical receptacles, etc., as shown on the Plans. Terminate field wiring on terminal blocks with the voltage and current rating of the terminal block is greater than the voltage and current rating of the wire fastened to it.

Furnish a power distribution assembly that fits in the EIA 19-inch rack and provides for protection and distribution of 120VAC power.

Ensure that ground bus bars are fabricated from a copper alloy material compatible with copper wire. Use ground bus bars that have at least two positions where a #6 AWG stranded copper wire can be attached.

Mount the ground bus bar on the side of the cabinet wall adjacent to the service panel assembly for the connection of AC neutral wires and chassis ground wires. If more than one ground bus bar is used in a cabinet, use a minimum of a #10 AWG copper wire to interconnect them.

Wire into the cabinet's circuitry the connector harnesses for the ITS devices and other accessory equipment to be housed therein.

Terminate conductors on terminal blocks using insulated terminal lugs large enough to accommodate the conductor to be terminated. When two or more conductors are terminated on field wiring terminal block screws, use a terminal ring lug for termination of those conductors. Number all terminal block circuits and cover the blocks with a clear insulating material to prevent inadvertent contact.

8.4. CONSTRUCTION METHODS

A. General:

Locate cabinets so as not to obstruct sight distance of vehicles turning on red.

B. Base Mounted:

Install base mounted cabinets as shown on the plans and as approved by the Engineer. Refer to Section 1750 - Signal Cabinet Foundations of the *Standard Specifications* for installation requirements for the foundations. The following exceptions are made:

- Install only the required number of conduits as shown on the plans plus one additional spare stub out conduit.
- All other requirements apply.

8.5. MEASUREMENT AND PAYMENT

Actual number of fiber-optic hub cabinets (base mounted) furnished, installed, and accepted.

No measurement will be made for the cabinet foundation as it will be covered under Section 1750 – Signal Cabinet Foundations of the *Standard Specifications*.

No measurement will be made for installing the cellular telephone modem as this will be considered incidental to furnishing and installing the hub cabinet.

Payment will be made under:

Pay Item	Pay Unit
Fiber-optic Hub Cabinet (base mounted).....	Each

9. ETHERNET EDGE SWITCH

Furnish and install a managed Ethernet edge switch as specified below that is fully compatible, interoperable, and completely interchangeable and functional within the existing Division or Statewide traffic signal system communications network.

9.1. DESCRIPTION

A. Ethernet Edge Switch:

Furnish and install a hardened, field Ethernet edge switch (hereafter “edge switch”) for traffic signal controllers as specified below. Ensure that the edge switch provides wire-speed, fast Ethernet connectivity at transmission rates of 100 megabits per second from each remote ITS device location to the routing switches.

Contact NCDIT to arrange for the programming of the new Field Ethernet Switches with the necessary network configuration data, including but not limited to, the IP Address, Default Gateway, Subnet Mask and VLAN ID information. Provide a minimum ten (10) working days notice to allow NCDIT to program the new devices.

B. Network Management:

Ensure that the edge switch is fully compatible with the existing Division or Statewide Network Management Software.

9.2. MATERIALS

A. General:

Ensure that the edge switch is fully compatible and interoperable with the trunk Ethernet network interface and that the edge switch supports half and full duplex Ethernet communications.

Furnish an edge switch that provide 99.999% error-free operation, and that complies with the Electronic Industries Alliance (EIA) Ethernet data communication requirements using single-mode fiber-optic transmission medium and copper transmission medium. Ensure that the edge switch has a minimum mean time between failures (MTBF) of 10 years, or 87,600 hours, as calculated using the Bellcore/Telcordia SR-332 standard for reliability prediction.

B. Compatibility Acceptance

The Engineer has the authority to require the Contractor to submit a sample Field Ethernet Switch and SFP along with all supporting documentation, software, and testing procedures to allow a compatibility acceptance test to be performed prior to approving the proposed Field Ethernet Switch and Field Ethernet Transceiver for deployment. **The Compatibility Acceptance testing will ensure that the proposed device is 100% compatible and interoperable with the existing Division or Statewide Signal System network, monitoring software and Traffic Operations Center network hardware.** Allow fifteen (15) working days for the Compatibility Acceptance Testing to be performed

C. Standards:

Ensure that the edge switch complies with all applicable IEEE networking standards for Ethernet communications, including but not limited to:

- IEEE 802.1D standard for media access control (MAC) bridges used with the Spanning Tree Protocol (STP);
- IEEE 802.1Q standard for port-based virtual local area networks (VLANs);
- IEEE 802.1P standard for Quality of Service (QoS);
- IEEE 802.1w standard for MAC bridges used with the Rapid Spanning Tree Protocol (RSTP);
- IEEE 802.1s standard for MAC bridges used with the Multiple Spanning Tree Protocol;
- IEEE 802.1x standard for port based network access control, including RADIUS;
- IEEE 802.3 standard for local area network (LAN) and metropolitan area network (MAN) access and physical layer specifications;
- IEEE 802.3u supplement standard regarding 100 Base TX/100 Base FX;
- IEEE 802.3x standard regarding flow control with full duplex operation; and
- IFC 2236 regarding IGMP v2 compliance.

- IEEE 802.1AB Link Layer Discovery Protocol (LLDP)
- IEEE 802.3ad Ethernet Link Aggregation
- IEEE 802.3i for 10BASE-T (10 Mbit/s over Fiber-Optic)
- IEEE 802.3ab for 1000BASE-T (1Gbit/s over Ethernet)
- IEEE 802.3z for 1000BASE-X (1 Gbit/s Ethernet over Fiber-Optic)

D. Functional:

Ensure that the edge switch supports all Layer 2 management features and certain Layer 3 features related to multicast data transmission and routing. These features shall include, but not be limited to:

- An STP healing/convergence rate that meets or exceeds specifications published in the IEEE 802.1D standard.
- An RSTP healing/convergence rate that meets or exceeds specifications published in the IEEE 802.1w standard.
- An Ethernet edge switch that is a port-based VLAN and supports VLAN tagging that meets or exceeds specifications as published in the IEEE 802.1Q standard and has a minimum 4-kilobit VLAN address table (254 simultaneous).
- A forwarding/filtering rate that is a minimum of 14,880 packets per second for 10 megabits per second and 148,800 packets per second for 100 megabits per second.
- A minimum 4-kilobit MAC address table.
- Support of Traffic Class Expediting and Dynamic Multicast Filtering.
- Support of, at a minimum, snooping of Version 2 & 3 of the Internet Group Management Protocol (IGMP).
- Support of remote and local setup and management via telnet or secure Web-based GUI and command line interfaces.
- Support of the Simple Network Management Protocol version 3 (SNMPv3). Verify that the Ethernet edge switch can be accessed using the resident EIA-232 management port, a telecommunication network, or the Trivial File Transfer Protocol (TFTP).
- Port security through controlling access by the users. Ensure that the Ethernet edge switch has the capability to generate an alarm and shut down ports when an unauthorized user accesses the network.
- Support of remote monitoring (RMON-1 & RMON-2) of the Ethernet agent.
- Support of the TFTP and SNMP. Ensure that the Ethernet edge switch supports port mirroring for troubleshooting purposes when combined with a network analyzer.

E. Physical Features:

Ports: Provide 10/100/1000 Mbps auto-negotiating ports (RJ-45) copper Fast Ethernet ports for all edge switches. Provide auto-negotiation circuitry that will automatically negotiate the highest possible data rate and duplex operation possible with attached devices supporting the IEEE 802.3 Clause 28 auto-negotiation standard.

Optical Ports: Ensure that all fiber-optic link ports operate at 1310 or 1550 nanometers in single mode. Provide Type LC connectors for the optical ports, as specified in the Plans or by the Engineer. Do not use mechanical transfer registered jack (MTRJ) type connectors.

Provide an edge switch having a minimum of two optical 100/1000 Base X ports capable of transmitting data at 100/1000 megabits per second. Ensure that each optical port consists of a pair of fibers; one fiber will transmit (TX) data and one fiber will receive (RX) data. Ensure that the optical ports have an optical power budget of at least 15 dB.

Copper Ports: Provide an edge switch that includes a minimum of four copper ports. Provide Type RJ-45 copper ports and that auto-negotiate speed (i.e., 10/100/1000 Base) and duplex (i.e., full or half). Ensure that all 10/100/1000 Base TX ports meet the specifications detailed in this section and are compliant with the IEEE 802.3 standard pinouts. Ensure that all Category 5E unshielded twisted pair/shielded twisted pair network cables are compliant with the EIA/TIA-568-B standard.

Port Security: Ensure that the edge switch supports/complies with the following (remotely) minimum requirements:

- Ability to configure static MAC addresses access;
- Ability to disable automatic address learning per ports; know hereafter as Secure Port. Secure Ports only forward; and
- Trap and alarm upon any unauthorized MAC address and shutdown for programmable duration. Port shutdown requires administrator to manually reset the port before communications are allowed.

F. Management Capabilities:

Ensure that the edge switch supports all Layer 2 management features and certain Layer 3 features related to multicast data transmission and routing. These features shall include, but not be limited to:

- An STP healing/convergence rate that meets or exceeds specifications published in the IEEE 802.1 D standards;
- An RSTP healing/convergence rate that meets or exceeds specifications published in the IEEE 802.1w standard;
- An Ethernet edge switch that is a port-based VLAN and supports VLAN tagging that meets or exceeds specifications as published in the IEEE 802.1Q standard, and has a minimum 4-kilobit VLAN address table (254 simultaneous);
- A forwarding/filtering rate that is a minimum of 14,880 packets per second for 10 megabits per second, 148,800 packets per second for 100 megabits per second and 1,488,000 packets per second for 1000 megabits per second;
- A minimum 4-kilobit MAC address table;
- Support of Traffic Class Expediting and Dynamic Multicast Filtering.
- Support of, at a minimum, snooping of Version 2 & 3 of the Internet Group Management Protocol (IGMP);
- Support of remote and local setup and management via telnet or secure Web-based GUI and command line interfaces; and
- Support of the Simple Network Management Protocol (SNMP). Verify that the Ethernet edge switch can be accessed using the resident EIA-232 management port, a telecommunication network, or the Trivial File Transfer Protocol (TFTP).

Network Capabilities: Provide an edge switch that supports/complies with the following minimum requirements:

- Provide full implementation of IGMPv2 snooping (RFC 2236);
- Provide full implementation of SNMPv1, SNMPv2c, and/or SNMPv3;
- Provide support for the following RMON–I groups, at a minimum:
 - Part 1: Statistics
 - Part 2: History
 - Part 3: Alarm
 - Part 9: Event
- Provide support for the following RMON–2 groups, at a minimum:
 - Part 13: Address Map
 - Part 16: Layer Host
 - Part 17: Layer Matrix
 - Part 18: User History
- Capable of mirroring any port to any other port within the switch;
- Meet the IEEE 802.1Q (VLAN) standard per port for up to four VLANs;

- Meet the IEEE 802.3ad (Port Trunking) standard for a minimum of two groups of four ports;
- Password manageable;
- Telnet/CLI;
- HTTP (Embedded Web Server) with Secure Sockets Layer (SSL); and
- Full implementation of RFC 783 (TFTP) to allow remote firmware upgrades.

Network Security: Provide an edge switch that supports/complies with the following (remotely) minimum network security requirements:

- Multi-level user passwords;
- RADIUS centralized password management (IEEE 802.1X);
- SNMPv3 encrypted authentication and access security;
- Port security through controlling access by the users: ensure that the Ethernet edge switch has the capability to generate an alarm and shut down ports when an unauthorized user accesses the network;
- Support of remote monitoring (RMON-1&2) of the Ethernet agent; and
- Support of the TFTP and SNTP. Ensure that the Ethernet edge switch supports port mirroring for troubleshooting purposes when combined with a network analyzer.

G. Electrical Specifications:

Ensure that the edge switch operates and power is supplied with 115 volts of alternating current (VAC). Ensure that the edge switch has a minimum operating input of 110 VAC and a maximum operating input of 130 VAC. Ensure that if the device requires operating voltages other than 120 VAC, supply the required voltage converter. Ensure that the maximum power consumption does not exceed 50 watts. Ensure that the edge switch has diagnostic light emitting diodes (LEDs), including link, TX, RX, speed (for Category 5E ports only), and power LEDs.

H. Environmental Specifications:

Ensure that the edge switch performs all of the required functions during and after being subjected to an ambient operating temperature range of -30 degrees to 165 degrees Fahrenheit as defined in the environmental requirements section of the NEMA TS 2 standard, with a noncondensing humidity of 0 to 95%.

Provide certification that the device has successfully completed environmental testing as defined in the environmental requirements section of the NEMA TS 2 standard. Provide certification that the device meets the vibration and shock resistance requirements of Sections 2.1.9 and 2.1.10, respectively, of the NEMA TS 2 standard. Ensure that the edge switch is protected from rain, dust, corrosive elements, and typical conditions found in a roadside environment.

The edge switch shall meet or exceed the following environmental standards:

- IEEE 1613 (electric utility substations)
- IEC 61850-3 (electric utility substations)
- IEEE 61800-3 (variable speed drive systems)
- IEC 61000-6-2 (generic industrial)
- EMF – FCC Part 15 CISPR (EN5502) Class A

I. Ethernet Patch Cable:

Furnish a factory pre-terminated/pre-connectorized Ethernet patch cable with each edge switch. Furnish Ethernet patch cables meeting the following physical requirements:

- Five (5)-foot length
- Category 5e or better
- Factory-installed RJ-45 connectors on both ends
- Molded anti-snap hoods over connectors
- Gold plated connectors

Furnish Fast Ethernet patch cords meeting the following minimum performance requirements:

- TIA/EIA-568-B-5, Additional Transmission Performance Specifications for 4-pair 100 Ω Enhanced Category 5 Cabling
- Frequency Range: 1-100 MHz
- Near-End Crosstalk (NEXT): 30.1 dB
- Power-sum NEXT: 27.1 dB
- Attenuation to Crosstalk Ratio (ACR): 6.1 dB
- Power-sum ACR: 3.1 dB
- Return Loss: 10dB
- Propagation Delay: 548 nsec

9.3. CONSTRUCTION METHODS**A. General:**

Ensure that the edge switch is UL listed.

Verify that network/field/data patch cords meet all ANSI/EIA/TIA requirements for Category 5E and Category 6 four-pair unshielded twisted pair cabling with stranded conductors and RJ45 connectors.

Contact the Division or NCDIT a minimum of 10 working days prior to installation to allow for the programming of the edge switch.

B. Edge Switch:

Mount the edge switch inside each field cabinet by securely fastening the edge switch to the upper end of the right rear vertical rail of the equipment rack using manufacturer-recommended or Engineer-approved attachment methods, attachment hardware and fasteners.

Ensure that the edge switch is mounted securely in the cabinet and is fully accessible by field technicians without blocking access to other equipment. Verify that fiber-optic jumpers consist of a length of cable that has connectors on both ends, primarily used for interconnecting termination or patching facilities and/or equipment.

9.4. MEASUREMENT AND PAYMENT

Ethernet edge switch will be measured and paid as the actual number of Ethernet edge switches furnished, installed, and accepted.

U-6022

TS-56

Wake County

No separate measurement will be made for Ethernet patch cable, power cord, mounting hardware, nuts, bolts, brackets, or edge switch programming as these will be considered incidental to furnishing and installing the edge switch.

Payment will be made under:

Pay Item	Pay Unit
Ethernet Edge Switch.....	Each

10. DIGITAL CCTV CAMERA ASSEMBLY

10.1. DESCRIPTION

Furnish and install a Digital CCTV Camera Assembly as described in these Project Special Provisions. All new CCTV cameras shall be fully compatible with the video management software currently in use by the Region and the Statewide Traffic Operations Center (STOC). Provide a Pelco Spectra Enhanced low light 30X minimum zoom, Axis Dome Network Camera low light 30X minimum zoom or an approved equivalent that meets the requirements of these Project Special Provisions.

10.2. MATERIALS

A. General

Furnish and install new CCTV camera assembly at the locations shown on the Plans and as approved by the Engineer. Each assembly consists of the following:

- One dome CCTV color digital signal processing camera unit with zoom lens, filter, control circuit, and accessories in a single enclosed unit
- A NEMA-rated enclosure constructed of aluminum with a clear acrylic dome or approved equal Camera Unit housing.
- Motorized pan, tilt, and zoom
- Built-in video encoder capable of H.264/MPEG-4 compression for video-over IP transmission
- Pole-mount camera attachment assembly
- A lightning arrestor installed in-line between the CCTV camera and the equipment cabinet components.
- All necessary cable, connectors, and incidental hardware to make a complete and operable system.

B. Camera and Lens

1. Cameras

Furnish a new CCTV camera that utilizes charged-coupled device (CCD) technology or Complementary Metal-Oxide-Semiconductor (CMOS) technology. The camera must meet the following minimum requirements:

- Video Resolution: Minimum 1920x1080 (HDTV 1080p)
- Aspect Ratio: 16:9
- Overexposure protection: The camera shall have built-in circuitry or a protection device to prevent any damage to the camera when pointed at strong light sources, including the sun

- Low light condition imaging
- Wide Dynamic Range (WDR) operation
- Electronic Image Stabilization (EIS)
- Automatic focus with manual override

2. Zoom Lens

Furnish each camera with a motorized zoom lens that is a high-performance integrated dome system or approved equivalent with automatic iris control with manual override and neutral density spot filter. Furnish lenses that meet the following optical specifications:

- 30X minimum optical zoom, and 12X minimum digital zoom
- Preset positioning: minimum of 128 presets

The lens must be capable of both automatic and remote manual control iris and focus override operation. The lens must be equipped for remote control of zoom and focus, including automatic movement to any of the preset zoom and focus positions. Mechanical or electrical means must be provided to protect the motors from overrunning in extreme positions. The operating voltages of the lens must be compatible with the outputs of the camera control.

3. Communications:

The CCTV camera shall support the appropriate NTCIP 1205 communication protocol (version 1.08 or higher), ONVIF Profile G protocol, or approved equal.

4. Networking Standards:

- Network Connection: 10/100 Mbps auto-negotiate
- Frame Rate: 30 to 60 fps
- Data Rate: scalable
- Built-in Web Server
- Unicast & multicast support
- Two simultaneous video streams (Dual H.264 and MJPEG):
 - Video 1: H.264 (Main Profile, at minimum)
 - Video 2: H.264 or MJPEG
- Supported Protocols: DNS, IGMPv2, NTP, RTSP, RTP, TCP, UDP, DHCP, HTTP, IPv4, IP6
- 130 dB Wide Dynamic Range (WDR)

The video camera shall allow for the simultaneous encoding and transmission of the two digital video streams, one in H.264 format (high-resolution) and one in H.264 or MJPEG format (low-resolution).

Initially use UDP/IP for video transport and TCP/IP for camera control transport unless otherwise approved by the Engineer.

The 10/100BaseTX port shall support half-duplex or full-duplex and provide auto negotiation and shall be initially configured for full-duplex.

The camera unit shall be remotely manageable using standard network applications via web browser interface administration. Telnet or SNMP monitors shall be provided.

C. Camera Housing

Furnish new dome style enclosure for the CCTV assembly. Equip each housing with mounting assembly for attachment to the CCTV camera pole. The enclosures must be equipped with a sunshield and be fabricated from corrosion resistant aluminum and finished in a neutral color of weather resistant enamel. The enclosure must meet or exceed NEMA 4X ratings. The viewing area of the enclosure must be tempered glass. The pendant must meet NEMA Type 4X, IP66 rating and use 1-1/2-inch NPT thread. The sustained operating temperature must be -50 to 60C (-58 to 144F), condensing temperature 10 to 100% Relative Humidity (RH).

D. Pan and Tilt Unit

Equip each new dome style assembly with a pan and tilt unit. The pan and tilt unit must be integral to the high-performance integrated dome system. The pan and tilt unit must be rated for outdoor operation, provide dynamic braking for instantaneous stopping, prevent drift, and have minimum backlash. The pan and tilt units must meet or exceed the following specifications:

- a. Pan: continuous 360 Degrees rotation
- b. Tilt: up/down +2 to -90 degrees minimum
- c. Motors: Two-phase induction type, continuous duty, instantaneous reversing
- d. Preset Positioning: minimum of 128 presets
- e. Low latency for improved Pan and Tilt Control
- f. FCC, Class A; UL/cUL Listed

E. Video Ethernet Encoder

Furnish cameras with a built-in digital video Ethernet encoder to allow video-over-IP transmission. The encoder units must be built into the camera housing and require no additional equipment to transmit encoded video over IP networks.

Encoders must have the following minimum features:

- Network Interface: Ethernet 10/100Base-TX (RJ-45 connector)
- Protocols: IPv4, Ipv6, HTTP, UpnP, DNS, NTP, RTP, RTSP, TCP, UDP, IGMP, and DHCP
- Security: SSL, SSH, 802.1x, HTTPS encryption with password-controlled browser interface
- Video Streams: Minimum 2 simultaneous streams, user configurable
- Compression: H.264 (MPEG-4 Part 10/AVC)
- Resolution Scalable: NTSC-compatible 320x176 to 1920x1080 (HDTV 1080p)
- Aspect Ratio: 16:9
- Frame Rate: 1-30 FPS programmable (full motion)
- Bandwidth: 30 kbps – 6 Mbps, configurable depending on resolution
- Edge Storage: SD/SDHC/SDXC slot supporting up to 64GB memory card

F. Control Receiver/Driver

Provide each new camera unit with a control receiver/driver that is integral to the CCTV dome assembly. The control receiver/driver will receive serial asynchronous data initiated from a camera

control unit, decode the command data, perform error checking, and drive the pan/tilt unit, camera controls, and motorized lens. As a minimum, the control receiver/drivers must provide the following functions:

- Zoom in/out
- Automatic focus with manual override
- Tilt up/down
- Automatic iris with manual override
- Pan right/left
- Minimum 128 preset positions for pan, tilt, and zoom, 16 Preset Tours, 256 Dome Presets
- Up to 32 Window Blanks.

In addition, each control receiver/driver must accept status information from the pan/tilt unit and motorized lens for preset positioning of those components. The control receiver/driver will relay pan, tilt, zoom, and focus positions from the field to the remote camera control unit. The control receiver/driver must accept “goto” preset commands from the camera control unit, decode the command data, perform error checking, and drive the pan/tilt and motorized zoom lens to the correct preset position. The preset commands from the camera control unit will consist of unique values for the desired pan, tilt, zoom, and focus positions.

G. Electrical

The camera assembly shall support Power-over-Ethernet (PoE) in compliance with IEEE 802.3. Provide any external power injector that is required for PoE with each CCTV assembly.

H. CCTV Camera Attachment to Pole

Furnish and install an attachment assembly for the CCTV camera unit. Use stainless steel banding approved by the Engineer.

Furnish CCTV attachments that allow for the removal and replacement of the CCTV enclosure as well as providing a weatherproof, weather tight, seal that does not allow moisture to enter the enclosure.

Furnish a CCTV Camera Attachment Assembly that can withstand wind loading at the maximum wind speed and gust factor called for in these Special Provisions and can support a minimum camera unit dead load of 45 pounds (20.4 kg).

I. Riser

Furnish material meeting the requirements of Section 1091-3 and 1098-4 of the 2018 Standard Specifications for Roads and Structures. Furnish a 1” riser with weatherhead for instances where the riser is only carrying an Ethernet cable. For installations where fiber optic cable is routed to the cabinet through a 2” riser with heat shrink tubing the Contractor may elect to install the Ethernet cable in the same riser with the fiber cable.

J. Data line Surge Suppression

Furnish data line surge protection devices (SPD) shall meet the following minimum requirements:

- UL497B
- Service Voltage: < 60 V

U-6022**TS-60****Wake County**

- Protection Modes: L-G (All), L-L (All)
- Response Time: <5 nanoseconds
- Port Type: Shielded RJ-45 IN/Out
- Clamping Level: 75 V
- Surge Current Rating: 20 kA/Pair
- Power Handling: 144 Watts
- Data Rate: up to 10 GbE
- Operating Temperature: -40° F to + 158° F
- Standards Compliance: Cat-5e, EIA/TIA 568A and EIA/TIA 568B
- Warranty: Minimum of 5-year limited warranty

The data line surge protector shall be designed to operate with Power Over Ethernet (POE) devices. The SPD shall be designed such that when used with shielded cabling, a separate earth ground is not required. It shall be compatible with Cat-5e, Cat 6, and Cat-6A cabling.

Protect the electrical and Ethernet cables from the CCTV unit entering the equipment cabinet with surge protection. Provide an integrated unit that accepts unprotected electrical and Ethernet connections and outputs protected electrical and Ethernet connections.

K. POE Injector

Furnish POE Injectors meeting the following minimum performance requirements and that is compatible with the CCTV Camera and Ethernet Switch provided for the project.

- Working temp/humidity: 14° F to 131° F/maximum 90%, non-condensing
- Connectors: Shielded RJ-45, EIA 568A and EIA 568B
- Input Power: 100 to 240 VAC, 50 to 60 Hz
- Pass Through Data Rates: 10/100/1000 Mbps
- Regulatory: IEEE 802.3at (POE)
- Number of Ports: 1 In and 1 Out
- Safety Approvals: UL Listed

Ensure the POE Injector is designed for Plug-and-Play installation, requiring no configurations and supports automatic detection and protection of non-standard Ethernet Terminal configurations.

10.3. Construction Methods

A. General

Obtain approval of the camera locations and orientation from the Engineer prior to installing the CCTV camera assembly.

Mount CCTV camera units at a height to adequately see traffic in all directions and as approved by the Engineer. The maximum attachment height is 45 feet above ground level unless specified elsewhere or directed by the Engineer.

Mount the CCTV camera units such that a minimum 5 feet of clearance is maintained between the camera and the top of the pole.

Mount CCTV cameras on the side of poles nearest intended field of view. Avoid occluding the view with the pole.

Install the data line surge protection device and POE Injector in accordance with the manufacturer's recommendations.

Install the riser in accordance with Section 1722-3 of the 2018 Standard Specifications for Roads and Structures. Install the Ethernet cable in the riser from the field cabinet to the CCTV camera.

B. Electrical and Mechanical Requirements

Install an "Air Terminal and Lightning Protections System" in accordance with the Air Terminal and Lightning Protection System Project Special Provisions for the CCTV Camera Assembly. Ground all equipment as called for in the Standard Specifications, these Special Provisions, and the Plans. **Do not install lightning protection when installing a CCTV camera assembly on a signal pole.**

Install surge protectors on all ungrounded conductors entering the CCTV enclosure.

C. General Test Procedure

Test the CCTV Camera and its components in a series of functional tests and ensure the results of each test meet the specified requirements. These tests should not damage the equipment. The Engineer will reject equipment that fails to fulfill the requirements of any test. Resubmit rejected equipment after correcting non-conformities and re-testing; completely document all diagnoses and corrective actions. Modify all equipment furnished under this contract, without additional cost to the Department, to incorporate all design changes necessary to pass the required tests.

Provide 4 copies of all test procedures and requirements to the Engineer for review and approval at least 30 days prior to the testing start date.

Only use approved procedures for the tests. Include the following in the test procedures:

- A step-by-step outline of the test sequence that demonstrates the testing of every function of the equipment or system tested
- A description of the expected nominal operation, output, and test results, and the pass / fail criteria
- An estimate of the test duration and a proposed test schedule
- A data form to record all data and quantitative results obtained during the test
- A description of any special equipment, setup, manpower, or conditions required by the test

Provide all necessary test equipment and technical support. Use test equipment calibrated to National Institute of Standards and Technology (NIST) standards. Provide calibration documentation upon request.

Conform to these testing requirements and the requirements of these specifications. It is the Contractor's responsibility to ensure the system functions properly even after the Engineer accepts the CCTV test results.

Provide 4 copies of the quantitative test results and data forms containing all data taken, highlighting any non-conforming results and remedies taken, to the Engineer for approval. An authorized representative of the manufacturer must sign the test results and data forms.

D. Compatibility Tests

Compatibility Tests are applicable to CCTV cameras that the Contractor wishes to furnish but are of a different manufacturer or model series than the existing units installed in the Region. If required, the Compatibility Test shall be completed and accepted by the Engineer prior to approval of the material submittal.

The Compatibility Test shall be performed in a laboratory environment at a facility chosen by the Engineer based on the type of unit being tested. Provide notice to the Engineer with the material submitted that a Compatibility Test is requested. The notice shall include a detailed test plan that will show compatibility with existing equipment. The notice shall be given a minimum of 15 calendar days prior to the beginning of the Compatibility Test.

The Contractor shall provide, install, and integrate a full-functioning unit to be tested. The Department will provide access to existing equipment to facilitate these testing procedures. The Engineer will determine if the Compatibility Test was acceptable for each proposed device. To prove compatibility the Contractor is responsible for configuring the proposed equipment at the applicable Traffic Operations Center (TOC) with the accompaniment of an approved TOC employee.

E. Operational Field Test (On-Site Commissioning)

Final CCTV locations must be field verified and approved by the Engineer. Perform the following local operational field tests at the camera assembly field site in accordance with the test plans and in the presence of the Engineer. The Contractor is responsible for providing a laptop for camera control and positioning during the test. After completing the installation of the camera assemblies, including the camera hardware, power supply, and connecting cables, the contractor shall:

F. Local Field Testing

Furnish all equipment and labor necessary to test the installed camera and perform the following tests before any connections are made.

- Verify that physical construction has been completed.
- Inspect the quality and tightness of ground and surge protector connections.
- Check the power supply voltages and outputs, check connection of devices to power source.
- Verify installation of specified cables and connection between the camera, PTZ, camera control receiver, and control cabinet.
- Make sure cabinet wiring is neat and labeled properly; check wiring for any wear and tear; check for exposed or loose wires.
- Perform the CCTV assembly manufacturer's initial power-on test in accordance with the manufacturer's recommendation.
- Set the camera control address.
- Exercise the pan, tilt, zoom, and focus operations along with preset positioning, and power on/off functions.

U-6022

TS-63

Wake County

- Demonstrate the pan, tilt and zoom speeds and movement operation meet all applicable standards, specifications, and requirements.
- Define, test and/or change presets.
- Ensure camera field of view is adjusted properly and there are no objects obstructing the view.
- Ensure camera lens is dust-free.
- Ensure risers are bonded and conduits entering cabinets are sealed properly.
- Lightning arrestor bonded correctly.

G. Central Operations Testing

- Interconnect the CCTV Camera’s communication interface device with one of the following methods as depicted on the plans:
 - communication network’s assigned Ethernet switch and assigned fiber-optic trunk cable and verify a transmit/receive LED is functioning and that the CCTV camera is fully operational at the TOC.

OR

 - to the DOT furnished cellular modem and verify a transmit/receive LED is functioning and that the CCTV camera is fully operational at the TOC.
- Exercise the pan, tilt, zoom, and focus operations along with preset positioning, and power on/off functions.
- Demonstrate the pan, tilt, and zoom speeds and movement operation meet all applicable standards, specifications, and requirements.
- Define, test and/or change presets.

Approval of Operational Field Test results does not relieve the Contractor to conform to the requirements in these Project Special Provisions. If the CCTV system does not pass these tests, document a correction, or substitute a new unit as approved by the Engineer. Re-test the system until it passes all requirements.

10.4. Measurement and Payment

Digital CCTV Camera Assembly will be measured and paid as the actual number of digital CCTV assemblies furnished, installed, integrated, and accepted. No separate measurement will be made for electrical cabling, connectors, CCTV camera attachment assemblies, conduit, condulets, risers, grounding equipment, surge protectors, PoE Injectors, PoE Cable, Air Terminal and Lightning Protection System, compatibility testing, operational testing or any other equipment or labor required to install the digital CCTV assembly.

Payment will be made under:

Pay Item	Pay Unit
Digital CCTV Camera Assembly	Each

11. ELECTRICAL SERVICE

11.1. DESCRIPTION

At locations called out in the Plans, install electrical service, including an external disconnect and meter base.

Comply with the National Electrical Code (NEC), the National Electrical Safety Code (NESC), the *Standard Specifications*, these Project Special Provisions, and all local ordinances. Coordinate all work involving electrical service with the appropriate utility company and the Engineer.

Obtain the maximum available ground fault current from the utility company. Print this information on a durable label and adhere to the dead front of the disconnect.

11.2. MATERIALS

A. Electrical Service

Provide material, equipment and hardware under this section that is pre-approved on the 2018 ITS and Signals QPL by the date of equipment installation.

Provide, modify and/or upgrade all materials necessary to form a complete electrical service assembly as shown in the Plans. Furnish new external electrical service disconnects, meter bases, and required grounding. Replace electrical service feeder conductors and conduits between the disconnects and the hub cabinet as required.

Provide all electrical service disconnects with a space/expansion slots, covered by a knockout or removable blank cover, designed to allow the future installation of at least one additional circuit breaker.

Provide inverse time circuit breaker with at least 10,000 RMS symmetrical amperes short circuit current rating in a lockable NEMA 3R enclosure.

Furnish 3-wire stranded copper feeder conductors with THWN rating for supplying power to field equipment cabinets. Provide conductors with black, white, and green insulation that are intended for power circuits at 600 V or less and comply with the following:

- Listed as meeting UL Standard UL-83
- Meets ASTM B-3 and B-8 or B-787 standards.

Furnish 1" rigid galvanized conduit between the disconnect and the equipment cabinets as required. For underground runs greater than 10 feet in length, the Contractor may transition from 1" rigid galvanized conduit to 1" PVC conduit for the remainder of the underground run beyond the initial 10 feet. Furnish Schedule 40 PVC female adapters to connect the PVC conduit to the threaded end of the rigid galvanized conduit. The interior surface of one end of the PVC female adapter shall be compatibly threaded to connect it to the threaded end of the rigid metallic riser without the aid of additional fittings, hardware or adhesives. The opposite end of the adapter shall be non-threaded to permit a slip fit, glued connection to the underground PVC conduit.

Ensure service disconnects are listed as meeting UL Standard UL-489 and marked as being suitable for use as service equipment. Fabricate enclosure from galvanized steel. Provide ground bus and neutral bus with a minimum of four terminals with minimum wire capacity range of number 8 through number 2/0 AWG.

Where the Plans call for modifying an existing electrical service for a traffic signal, provide a single-pole 50A inverse time circuit breaker with at least 10,000 RMS symmetrical amperes short circuit current rating to replace an existing circuit breaker in an existing disconnect.

B. Grounding Electrodes (Ground Rods)

Furnish 5/8"x10' copper clad steel grounding electrodes (ground rods), #4 AWG solid bare copper conductors, and irreversible compression connections for grounding system installations. Comply with the NEC, the Standard Specifications, these Project Special Provisions and the Plans.

C. Service Conductors

For the modified electrical service for the hub cabinet, provide service conductors between the modified electrical service and the Contractor-installed riser on the power company pole of the number and size (gauge) required by the local power company. Furnish service conductors that comply with the material requirements and standards of the local power company.

11.3. CONSTRUCTION METHODS

A. General

All work involving electrical service shall be coordinated with the appropriate electric utility company. Coordinate with the utility company to ascertain the feasibility of installing electrical service at each location before performing any work. Obtain all required local permits before beginning work.

Run feeder conductors separately from all other conductors in a 1-inch rigid galvanized conduit. Do not allow feeder conductors to share conduits with any other conductors or cables. Do not route unfused electrical feeder conductors inside of metal poles. Permanently label conductors at all access points using nylon tags labeled with permanent ink. Ensure each conductor has a unique identifier. Label conductors immediately upon installation. Use component name and labeling scheme approved by the Engineer.

Use rigid galvanized conduit for all underground conduit runs 10 feet or less in length. For underground runs greater than 10 feet in length, the Contractor may transition from 1" rigid galvanized conduit to 1" PVC conduit for the remainder of the run beyond the initial 10 feet using an approved PVC female adapter. Apply thread seal tape to the threads of the rigid galvanized conduit before screwing the PVC adapter onto the threaded male end of the conduit. Connect the threaded female end of the PVC adapter to the threaded end of the rigid galvanized conduit, then connect the not threaded end of the adapter to the PVC conduit using a slip fit, glued connection.

Direct bury pedestals that support combination panel at a minimum embedment depth of 24 inches below grade.

For locations with new electrical service, install a 6" x 6" treated wood post a minimum of 3 feet into the ground and mount the electrical service equipment on the wood post.

Upon completion of electrical service installation and backfilling of all excavations, restore the disturbed ground to its original condition as determined and approved by the Engineer. For paved areas, replace removed or damaged pavement with in-kind materials, matching the elevation, color, texture/finish and general appearance of the surrounding pavement in accordance with the 2018 Standard Specifications for Roads and Structures. Refer to Section 1 of these Project Special Provisions for additional requirements concerning sidewalks and curbs in historic districts. For

U-6022**TS-66****Wake County**

unpaved areas, backfill excavations with removed material, tamp the backfilled material and rake smooth the top 1½ inches. Finish unpaved areas flush with surrounding natural ground and to match the original contour of the ground. Seed with same type of grass as surrounding area and mulch the newly seeded area. If unpaved area was not grassed, replace the original ground cover in kind as directed by the Engineer.

Complete repairs to and restoration of all ground (paved and unpaved) disturbed for construction within five consecutive calendar days following initial removal. If the Contractor fails to repair and restore the ground in accordance with these Project Special Provisions within the time frame specified, the Department reserves the right to make the necessary repairs, and all expenses incurred by the Department in making the repairs and restoring the ground will be deducted from payment due the Contractor, plus \$500 liquidated damages per occasion, per day, or any portion thereof, until corrected.

B. New Electrical Service

At locations identified in the Plans, install new electrical service for a hub cabinet in accordance with the details shown in the Plans. Install a new electrical service comprised of an external service disconnect and a meter base with meter socket cover housed in a combination panel. Mount the combination panel next to the pole identified in the plans. After installation of the meter base with meter socket cover, the local power company will remove the socket cover and transfer the existing meter or install a new meter and make any necessary connections to the power lines.

C. Grounding of Electrical Services

In addition to NEC requirements, test grounding electrode resistance at modified electrical service for a maximum of 20 ohms. Furnish and install additional ground rods to grounding electrode system as necessary to meet test requirements. Furnish 5/8" x 10' copper clad steel grounding electrode system (ground rods), #4 AWG solid bare copper conductors, and irreversible compression connectors for grounding system installations. Comply with NEC, the *Standard Specifications*, these Project Special Provisions and the Plans.

Modify existing electrical services, as necessary, to meet the grounding requirements of the NEC, these Project Special Provisions and the Plans. Remove any ground rods in the cabinet foundation and install a new grounding electrode system. Cut off abandoned ground rods in the cabinet foundation flush with the foundation surface. Where a grounding electrode system is connected to the electrical service in accordance with the NEC, test grounding electrode resistance for a maximum of 20 ohms. Grounding electrode resistance test must be verified or witnessed by the Engineer or the Engineer's designated representative. Furnish and install additional ground rods to grounding electrode system as necessary to meet the requirements of these Project Special Provisions and test requirements.

Follow test equipment's procedures for measuring grounding electrode resistance. When using clamp-type ground resistance meters, readings of less than 1 ohm typically indicate a ground loop. Rework bonding and grounding circuits as necessary to remove ground loop circuits and retest. If a ground loop cannot be identified and removed to allow the proper use of a clamp-type ground resistance meter, use the three-point test method.

Submit a completed Inductive Loop & Grounding Test Form available on the Department's website at:

<https://connect.ncdot.gov/resources/safety/Pages/ITS-and-Signals.aspx>

Install a length of marker tape 6 to 12 inches below finished grade directly over grounding electrodes and conductors.

11.4. MEASUREMENT AND PAYMENT

No measurement will be made of short risers (i.e., from disconnect to underground conduit and from underground conduit to bottom of cabinet), meter bases, meter socket covers, service disconnects, additional circuit breakers in new service disconnects where required, underground conduit runs less than 10 feet between service risers and disconnects/meters, conduit for feeder conductors between the service disconnect and the equipment cabinet, PVC female adapters, acquisition of service fees, service entrance conductors between top of riser and disconnect of an overhead electrical services assembly, feeder conductors between the disconnect and equipment cabinet, ground wire, 6” x 6” wood posts and any remaining hardware and conduit to connect the electrical service to the cabinet as they will be incidental to furnishing and installing new electrical service.

5/8” X 10’ *grounding electrode* (ground rod) will be measured and paid as the actual number of 5/8” copper clad steel ground rods furnished, installed, and accepted as part of grounding systems. No separate payment will be made for #4 AWG solid bare copper grounding conductors or irreversible compression connectors as they will be incidental to furnishing and installing the ground rod(s).

Service conductors will be measured and paid as the actual horizontal linear feet of underground run, furnished, installed and accepted, regardless of number and size of conductors. No measurement will be made of vertical segments.

Payment will be made under:

Pay Item	Pay Unit
New Electrical Service.....	Each
5/8” x 10’ Grounding Electrode.....	Each
Service Conductors	Linear Foot

12. ETHERNET CABLE

12.1. DESCRIPTION

Furnish and install copper Ethernet cable, as shown in the Plans, for interconnecting various hardware in an Ethernet network located in the traffic signal and hub cabinets.

12.2. MATERIALS

A. Ethernet Cable

Provide shielded Category 6 Ethernet outdoor-rated twisted-pair cable that complies with ANSI/TIA-568-C.2 standards for four-pair shielded twisted copper for Ethernet communications. The cable shall meet all mechanical requirements of ANSI/ICEA S-80-576 applicable to four-pair inside wiring cable for plenum or general cabling.

Furnish Ethernet cable meeting the following minimum performance requirements:

- Specified frequency range: 1-250 MHz
- Impedance: 100 ohms
- Return Loss: 19.8 dB

U-6022**TS-68****Wake County**

- Attenuation: 32.8 dB @ 250 MHz
- Near End Crosstalk (NEXT): 38.3 dB @ 250 MHz
- Power Sum NEXT: 36.3dB @ 250 MHz
- ELFNEXT: 19.8 dB @ 250 MHz
- Delay Skew: 45 ns
- Return Loss: 18.3 dB @ 250 MHz
- Capacitance: 15 pF/ft.

Furnish Ethernet cable meeting the following physical requirements:

- Jacket: PVC, UV resistant
- Jacket Color: Black
- Insulation: Polyolefin
- Core: Gel-filled or flooded core
- Binder: Clear mylar with 100% coverage
- Shield: Aluminum/mylar-polyester tape with 100% coverage
- Drain Wire: 24 AWG tinned copper
- Conductors: Solid copper
- Conductor Color Codes: White-Blue/Blue, White-Orange/Orange, White-Green/Green, White-Brown/Brown
- Conductor size: 23 AWG

For Ethernet cable installed in outdoors on aerial messenger cable and in underground conduits, provide the cable rated for such conditions (i.e., UV-resistant, wet conditions, etc.).

B. Cable Management

Wire and cable must provide integrated features to enhance cable management. Integrated cable management features shall include:

- Ascending Descending Sequential Foot Markings: The cable shall provide ascending/descending sequential foot markings printed on the cable jacket. The foot markings shall be used to determine the exact length of cable runs and/or determine the amount of cable remaining in/on a box or reel.
- Alphanumeric Cable Labeling Coding System: The cable shall provide alphanumeric cable labeling coding system printed on the cable jacket. The printed coding system shall include the following alphanumeric characters to allow cable identification without the need for separate adhesive-style labels: A, B, C, D, E, 0, 1, 2, 3, 4, 5, 6, 7, 8, 9. The coding system shall allow easy cable labeling using a standard waterproof marker for: identification of devices, device addresses, zone/circuit cable numbers, etc.
- Cable Colors: The cable shall be available with different color stripes and solid jacket colors. The cable coloring may be used with the alphanumeric cable labeling system to further enhance cable identification to maximize field productivity during system installation and/or maintenance and service.
- Integral Rip Cords: Cables 18 AWG and larger shall include an integral rip cord to provide for easier field stripping of the cable jacket.

Utilize pre-lubricated cable treated with a lubricant to increase cable pulling productivity and efficiency and to decrease the risk of cable damage due to excessive pulling strengths. A non-staining lubricant shall be applied to coat the full length of the cable during the manufacturing process. The lubricant shall produce a low coefficient of friction on the cable jacket material that reduces pulling friction by up to 70%. The lubricant shall continue to reduce friction after it has dried; remaining as a slippery film that retains lubricity for months after use. The cable lubricant shall comply with the physical and performance requirements of Telcordia Standard, TR-NWT-002811, and Generic Requirements for Cable Placing Lubricants. The lubricant shall not contain solvents nor have a flash point.

Furnish color coded cables to denote the type of connection between devices. The colors shall be:

- Exterior Cable - Black
- Field Device Cabinets:
 - Traffic Signal Controllers – Blue
 - Conflict Monitors - Red
 - CCTV Cameras – Black
 - Laptop - Gray

C. Connectors

Provide RJ-45 connectors with gold wire conductors terminated according EIA/TIA-568-A/568-B standards. Provide connectors with eight contacts. Furnish connectors appropriately rated for the cable being installed. Provide cables with factory-installed connectors for interior cables.

D. Ethernet Patch Cords

Furnish Fast Ethernet patch cords meeting the following physical requirements:

- Minimum of five (5)-foot length,
- Category 6,
- Factory pre-installed RJ-45 connectors on both ends,
- Molded anti-snag hoods over connectors, and
- Gold plated connectors.

Furnish Ethernet patch cords meeting the following minimum performance requirements:

- TIA/EIA-568-C.2, Additional Transmission Performance Specifications for 4-pair 100 Ω Category 6 Cabling.
- Specified frequency range: 1-250 MHz
- Impedance: 100 ohms
- Return Loss: 19.8 dB
- Attenuation: 32.8 dB @ 250 MHz
- Near End Crosstalk (NEXT): 38.3 dB @ 250 MHz
- Power Sum NEXT: 36.3dB @ 250 MHz
- ELFNEXT: 19.8 dB @ 250 MHz
- Delay Skew: 45 ns
- Return Loss: 18.3 dB @ 250 MHz
- Capacitance: 15 pF/ft.

E. Environmental Requirements

Provide 4-pair twisted copper Ethernet cable and connectors rated for an ambient operating temperature range of -30° to 165° F. The cable shall be shielded, outdoor-rated and have a UV resistant jacket. The void between the insulated copper pairs and the polyethylene outer jacket shall be injected with a water-resistant flooding compound.

12.3. CONSTRUCTION METHODS**A. General**

Install color-coded Category 6 Ethernet cable for traffic signal controller and hub cabinets. Use color-coded cable as described in these Project Special Provisions above.

Furnish all tools, equipment, materials, supplies, and hardware necessary to install a fully operational Ethernet cable system as depicted in the Plans. Install the Ethernet cable according to the latest version of the manufacturer's cable installation procedures and the industry-accepted installation standards, codes, and practices, or as directed by the Engineer.

Take all precautions necessary to ensure the Ethernet cable is not damaged during storage and installation. Do not step on the cable nor run over the cable with vehicles or equipment. Do not pull the cable over or around obstructions or along the ground.

Immediately cease work and notify the Engineer and the affected owner should damage to existing cables or equipment occur. Make the required repairs at no additional cost to the Department.

Provide the Engineer with three copies of the Ethernet cable manufacturer's recommended and maximum pulling tensions for each Ethernet cable size before the installation of Ethernet cable.

Install Ethernet cable in continuous lengths with no splices outside cabinets.

Cut cables to length to minimize coils of spare cable. Cut outer jacket and trim conductors per manufacturer's recommendations. Ensure all conductors extend to the end of the channel and make solid electrical contact with the gold connectors. Crimp the RJ-45 connector body to lock conductors in channels.

B. Aerial Installation

Use pole attachment hardware and roller guides with safety clips to install the aerial Ethernet cable.

Maintain tension during the pulling process for aerial run Ethernet cable by using a mechanical clutch (dynamometer) device with breakaway swivel approved by the Engineer. Do not exceed 80 percent of the manufacturer's maximum allowable pulling tension. Do not allow the Ethernet cable to contact the ground or other obstructions between the poles during installation. Do not use a motorized vehicle to generate cable-pulling forces.

C. Messenger Cable Installation

Double lash the Ethernet cable to the messenger cable where the messenger cable is used solely to support the communications cable.

Wrap the communications cable to the messenger cable using aluminum ribbon wraps where the messenger cable supports other cables (i.e., traffic signal cable, lead-in cable, etc.).

D. Underground Installation

Install underground Ethernet cable as shown in the Plans using cable-pulling lubricants approved by the Ethernet cable manufacturer and the Engineer. Obtain the Engineer’s approval of the cable lubricant and method of pulling before the installation of underground Ethernet cable.

Do not exceed 80 percent of the manufacturer's maximum pulling tension when installing underground Ethernet cable.

Use a clutch device (dynamometer) with breakaway swivel so as not to exceed the allowable pulling tension if the cable is pulled by mechanical means. Do not use a motorized vehicle to generate cable-pulling forces.

Keep tension on the cable reel and the pulling line at the start of each pull. Do not release the tension in the cable if the pulling operation is halted. Restart the pulling operation by gradually increasing the tension until the cable is in motion.

Set cable reels up on the same side of the junction box as the conduit section in which the cable is to be installed. Place the reel level and align the reel with the conduit section such that the cable will pass from the top of the reel in a smooth bend into the conduit without twisting. Do not pull the cable from the bottom of the reel. Manually feed the cable by rotating the reel. Do not pull the cable through intermediate junction boxes, pull boxes, handholes, or openings in conduit unless otherwise approved by the Engineer.

Crimp the RJ-45 connector body to lock conductors in channels. Test each connector from end to end.

E. Ethernet Patch Cords

Install Ethernet patch cords between Ethernet patch panels and devices and network interface box and devices.

12.4. MEASUREMENT AND PAYMENT

Ethernet cable will be measured and paid as the actual linear feet of Ethernet cable furnished, installed, and accepted regardless of the color of the outer jacket. Measurement will be made by calculating the difference in length markings located on outer jacket from start of run to end of run for each run. No measurement will be made of connectors as such work is incidental to installing the Ethernet cable.

No measurement will be made for Ethernet patch cables that connect adjacent devices/equipment (e.g., between an Ethernet edge switch and a controller housed in the same cabinet) as they will be incidental to furnishing and installing the equipment that they connect.

Payment will be made under:

Pay Item	Pay Unit
Ethernet Cable.....	Linear Foot

13. HAND-LASH & AERIAL CABLE PROTECTOR

13.1. DESCRIPTION

Hand-lash fiber-optic cables along messenger cable in locations as specified by the Plans. Install aerial cable protectors in these areas.

13.2. MATERIALS

Furnish aerial cable protectors designed to protect aerial fiber-optic communications cable from damage caused by tree limb abrasion. Provide cable protectors that are designed to fit over the cable as a wrap-around protective sleeve, that have a round shape and are fabricated with cable tie slots spaced approximately 12 inches apart along the entire length. Size the cable protectors to fit properly over cable(s) lashed to messenger cable in accordance with the manufacturer’s guidelines. Provide cable protectors that are constructed of rugged, durable dielectric material such as high density PVC that is black in color, formulated for outdoor use and has special additives to prevent degradation from ultraviolet light. Provide aerial cable protectors that are designed for a service life of at least 10 years.

13.3. MEASUREMENT AND PAYMENT

Hand-lash & Aerial Cable Protector will be measured and paid as the actual linear feet of fiber-optic cables hand-lashed and linear feet of aerial cable protectors installed.

Payment will be made under:

Pay Item	Pay Unit
Hand-lash & Aerial Cable Protector	Linear Foot

14. CCTV WOOD POLE

14.1. Description

Furnish and install wood poles, grounding systems and all necessary hardware for CCTV camera installations. Reference applicable Sections of Article 1720 of the 2018 Standard Specifications for Roads and Structures for Materials and Construction.

Furnish an air terminal and lightning protection system in accordance with the “Air Terminal & Lightning Protection System” Project Special Provisions.

Furnish and install wood poles with grounding systems and all necessary hardware in accordance with Section 1720 of the Standard Specifications.

14.2. Materials

Material, equipment, and hardware furnished under this section shall be pre-approved on the Department’s QPL. For Wood poles refer to Sub articles 1082-3(F) Treated Timber and Lumber – Poles and 1082-4(A) – General; 1082-4 (B) – Timber Preservatives; 1082-4(G) – Poles; in the 2018 Standard Specifications for Roads and Structures.

14.3. CCTV Wood Pole

Unless otherwise specified in the Plans, furnish Class 3 or better wood poles that are a minimum of 60’ long to permit the CCTV camera to be mounted approximately 45 feet above the ground and a minimum 5 feet from the top of the pole.

14.4. Construction Methods

Mark final pole locations and receive approval from the Engineer before installing poles. Comply with all requirements of Section 1720-3 of the Standard Specifications.

Install the required Air Terminal & Lightning Protection System as described in the Air Terminal & Lightning Protection Specifications and as referenced in the following Typical Details:

- CCTV Camera Installation for Wood Pole with Aerial Electrical Service
- CCTV Camera Installation for Wood Pole with Underground Electrical Service

14.5. Measurement and Payment

CCTV Wood Pole will be measured and paid as the actual number of wood poles for CCTV camera furnished, installed, and accepted.

No measurement will be made for equipment, labor and materials, to install the wood pole as these items of work will be incidental to furnishing and installing CCTV wood poles.

No measurement will be made for furnishing and installing the “Air Terminal and Lightning Protection System” as this will be considered incidental to the “CCTV Wood Pole” installation.

Payment will be made under:

Pay Item	Pay Unit
CCTV Wood Pole.....	Each

15. AIR TERMINAL & LIGHTNING PROTECTION SYSTEM

15.1. DESCRIPTION

Furnish an air terminal and lightning protection system that is comprised of items meeting UL 96 and UL 467 product standards for lightning protection and installed to be compliant with the National Fire Protection Association 780 Standards for Lightning Protection Systems. The lightning protection system shall consist of, as a minimum, an Air Terminal, vertical Air Terminal Base (wood pole) or Air Terminal Rod Clamps (metal pole), 28-Strand bare-copper lightning conductor, 4-point grounding systems (grounding electrodes), #4 AWG copper bonding conductors, marker tape and other miscellaneous hardware.

15.2. Materials

A. General

Reference the following Typical Details where applicable:

- CCTV Camera Installation for Wood Pole with Aerial Electrical Service
- CCTV Camera Installation for Wood Pole with Underground Electrical Service

B. Wood Pole

Furnish a UL Listed Class II, copper clad minimum 48” long by ½” diameter air terminal. Ensure the air terminal has a tapered tip with a rounded point on one end and is threaded on the connection end with standard Unified Coarse (UNC) 13 threads per inch.

Furnish a copper vertical air terminal base that has internal threading to accept a ½” diameter air terminal with UNC 13 threads per inch. Provide a base that allows for a minimum ¼” mounting hole to secure the base to the vertical side of a wood pole. Ensure the air terminal base includes (2) 5/16” cap screws to secure the bare copper lightning conductor. Additionally, provide (2) ½” copper tube straps (conduit clamps) to secure the air terminal and bare copper lightning conductor to the pole.

C. Copper Lightning Conductor and Ground Rods

Furnish a Class II rated copper lightning conductor which consists of 28 strands (minimum) of 15 AWG copper wires to form a rope-lay bare copper lightning conductor. Furnish 5/8" diameter, 10-foot-long copper-clad steel ground rods with a 10-mil thick copper cladding to serve as an integral part of the 4-point grounding system. Furnish irreversible mechanical clamps to secure the 28-strand lightning conductor, #4 AWG bare copper ground wires and grounding electrodes together to complete the grounding system.

15.3. Construction Methods

A. Wood Pole

Install the vertical air terminal base approximately 12" below the top of the wood pole and install the air terminal to the threaded connection on the base. Install a 1/2" copper tube strap (conduit clamp) over the air terminal, 6" from the top of the pole. Additionally, secure the copper lightning conductor under both 5/16" diameter cap screws located on the base. Install an additional 1/2" copper tube strap (conduit clamp) over the bare copper lightning conductor, 6" below the air terminal base. Locate the 1/4" mounting hole on the vertical air terminal base and install a 1/4" by 3" (minimum) long lag bolt through the base and into the wood pole to support the air terminal assembly.

Route the bare copper lightning conductor to maintain maximum horizontal separation from any risers that traverse up the pole. Secure the bare copper lightning conductor to the pole on 24" centers using copper cable clips. From the bottom of the pole (ground level) install a 2" by 10' long PVC U-Guard over the bare copper lightning conductor to protect the cable from vandalism.

B. Copper Lightning Conductor and Ground Rods

Install the 4-point grounding system by installing a central grounding electrode that is surrounded by a minimum of three (3) additional grounding electrodes spaced approximately 20 feet away from the central grounding electrode and approximately 120 degrees apart. Interconnect each grounding electrode using a #4 AWG bare copper conductor back to the central grounding electrode using irreversible mechanical crimps. Additionally, using an irreversible mechanical crimp, connect the bare copper lightning conductor to the central grounding electrode. Install each grounding electrode and its corresponding #4 AWG bare copper grounding wire and 28 strand copper lightning conductor such that the wires are 24" below grade. Install marker tape 12" below grade and above all grounding conductors.

In instances where right-of-way does not allow for ground rod spacing as required above, reference the 2018 Roadway Standard Drawings - Section 1700.02 "Electrical Service Grounding" for "Limited Shoulder" or "Restricted Space" installation alternatives.

Prior to connecting the lightning protection system to an electrical service, perform a grounding electrode test on the lightning protection system to obtain a maximum of 20 ohms or less. Install additional grounding electrodes as need to obtain the 20 ohms or less requirement. The grounding electrode resistance test shall be verified or witnessed by the Engineer or the Engineer's designated representative.

Follow test equipment's procedures for measuring grounding electrode resistance. When using clamp-type ground resistance meters, readings of less than one ohm typically indicate a ground loop. Rework bonding and grounding circuits as necessary to remove ground loop circuits and retest. If a ground loop cannot be identified and removed to allow the proper use of a clamp-type ground resistance meter, use the three-point test method. Submit a completed inductive Loop & Grounding Test Form available on the Department's website.

15.4. Measurement and Payment

No measurement will be made for furnishing and installing the “Air Terminal and Lightning Protection System” as this will be considered incidental to furnishing and installing “Digital CCTV Camera Assembly.”

16. REMOVE EXISTING EQUIPMENT

16.1. DESCRIPTION

At locations shown in the Plans, the construction includes the removal of existing equipment and assemblies during the installation of new equipment and assemblies.

16.2. CONSTRUCTION METHODS

Remove wireless communications equipment at locations shown in the Plans. Deliver removed wireless communications equipment to Division 5 Traffic Engineering.

16.3. MEASUREMENT AND PAYMENT

Remove Wireless Communications Equipment will be measured and paid as the actual number removed. All cabling, configuration, and testing or other labor or materials required to remove the wireless communications equipment will be considered incidental and not be paid for separately.

Payment will be made under:

Pay Item	Pay Unit
Remove Wireless Communications Equipment	Each

17. OBSERVATION PERIOD

17.1. 30-Day Observation Period

The 30-Day Observation Period shall be considered part of work to be completed by the project completion date.

Upon successful completion of all project work the 30-day Observation Period may commence. Examples of project work includes but is not limited to:

- Installation of all project devices and communications infrastructure.
- Field Acceptance Testing of all devices.
- Central System Testing of all devices and network communications.
- Correction of all deficiencies and punch list items. (including minor construction items)

This observation consists of a 30-day period of normal, day-to-day operations of the field equipment in operation with new or existing central equipment without any failures. The purpose of this period is to ensure that all components of the system function in accordance with the Plans and these Project Special Provisions.

Respond to system or component failures (or reported failures) that occur during the 30-day Observation Period within twenty-four (24) hours. Correct any failures within forty-eight (48) hours (includes time of notification). Any failure that affects a major system component as defined below for more than forty-eight (48) hours will suspend the timing of the 30-day Observation Period beginning at the time when the Contractor is was notified that the failure occurred. After the cause of such failures has been corrected, timing of the 30-day Observation Period will resume. System or component failures that necessitate a redesign of any component or a failure in any of the major system components exceeding a total of three (3) occurrences will terminate the 30-day Observation Period for that system. The 30-day Observation Period will be restarted from day zero when the redesigned components have been installed and/or the failures corrected. The major system components are:

- CCTV Cameras and Central Operations
- Dynamic Message Sign (DMS) and Central equipment/Operations
- Portable Changeable Message Sign (PCMS)
- Communications infrastructure (examples: Fiber, Radios, Ethernet Switches, Core Switches, etc.)
- Any other ITS Devices not named above (examples: DSRC radios, Radar and Out-of-Street Detection, signals, etc.)

17.2. Final Acceptance

Final system acceptance is defined as the time when all work and materials described in the Plans and these Project Special Provisions have been furnished and completely installed by the Contractor; all parts of the work have been approved and accepted by the Engineer; and successful completion of the 30-day observation period.

The completed System will be ready for final acceptance upon the satisfactory completion of all acceptance tests as detailed in their respective Section of the Project Special provisions; the rectification of all punch-list discrepancies; and the submittal of all project documentation including as-built plans.

17.3. Measurement and Payment

There will be no payment for this item of work as it is incidental to the project as a whole and to the item of work in which it is associated.

Type I and II Ground Disturbing Categorical Exclusion Action Classification Form

STIP Project No.	U-6022
WBS Element	47148.1.1
Federal Project No.	BGANY-0507(011)

- A. Project Description: Project U-6022 will update the closed loop signal system in the Town of Fuquay-Varina (Wake County). The project includes the installation of new infrastructure with approximately 24 miles of new fiber-optic cable (overhead and underground), 40 upgraded cabinets, one new hub cabinet, and the addition of three new Closed-Circuit Television (CCTV) cameras. The existing overhead signals and pedestrian signal equipment will be maintained. See **Figure 1** for a project location map.

This project will modernize and expand the existing traffic signal system and will take place within existing NCDOT right-of-way and public utility easements. The existing cabinets will be replaced and whenever possible, the current location and mounting method of the cabinet will be maintained. Overhead and underground cables will be placed on existing poles or in existing underground conduit, where feasible. NCDOT is coordinating with the utility providers on this project. The project is currently scheduled for construction to begin in State Fiscal Year (SFY) 2022 with an estimated total cost of approximately \$3,286,000.

Project impacts are anticipated to be minor as the system is versatile and capable of avoiding or minimizing environmental impacts in most locations. As a result, significant environmental effects are not anticipated from this project.

- B. Description of Need and Purpose: The purpose of the project is to modernize the existing computerized traffic signal system. Modernization of the traffic signal system will improve the effectiveness and efficiency of the roadway network by improving traffic signal timing.
- C. Categorical Exclusion Action Classification:

TYPE I A

- D. Proposed Improvements

8. Installation of fencing, signs, pavement markings, small passenger shelters, traffic signals, and railroad warning devices where no substantial land acquisition or traffic disruption will occur.

- E. Special Project Information:

Community Resources

The project will comply with Americans with Disabilities Act (ADA) requirements and best practices for pedestrian accessibility within public rights-of-way. The NCDOT Project Manager will coordinate with the NCDOT Division of Bicycle and Pedestrian Transportation and Work Zone Safety Program to ensure that temporary and permanent improvements do

not physically block pedestrian paths/ramps and that pedestrian detours or re-routing of sidewalks during construction comply with ADA standards and best practices.

Cultural Resources

Archaeological resources and historic properties have been documented in the vicinity of the project. However, the project will not extend outside of areas that have already been disturbed by previous construction, maintenance, and utility work. A “No Archaeological Survey Required Form” was completed by NCDOT Archaeology Group on June 4, 2019. In the unlikely event that archaeological remains are encountered during the signalization upgrade project, work will cease in that area and the NCDOT Archaeology Group will be notified immediately.

Project improvements primarily consist of replacing existing signal system equipment in the same location and no historic properties will be affected by this project. As a result, the NCDOT Historic Architecture and Landscapes Group completed a “No Historic Properties Present or Affected Form” on August 19, 2019.

Tribal Coordination

The project falls within a county in which a federally recognized Tribe, the Catawba Indian Nation has expressed an interest in ground disturbing activities. The Catawba Indian Nation was notified about the project and in a letter dated August 8, 2019 and asked to provide comments by August 21, 2019. The Catawba Indian Nation will be notified if Native American artifacts and/or human remains are located during the construction phase of the project.

Hazardous Materials

The majority of ground disturbing activities will take place within existing right-of-way and there are no anticipated impacts to hazardous material sites. Any contaminated soil encountered during construction is anticipated to be de minimis.

Section 4(f)/Section 6(f)

There are several park facilities located adjacent to the project and the Fuquay-Varina Recreation Center at South Park received funding from the Land and Water Conservation Fund (LWCF) in 1980. While potential Section 4(f) and Section 6(f) resources are located within the project study area, impacts to these resources are not anticipated.

Jurisdictional Features

A desktop review of jurisdictional resources will be conducted and areas where ground disturbing activities will take place near jurisdictional waters will be delineated prior to permitting. It is anticipated that any impacts to jurisdictional waters (wetlands or streams) would be minor. NCDOT will attempt to avoid and minimize impacts to streams and wetlands to the greatest extent practicable during final project design. Minor impacts could result in the need for a Nationwide Permit (NWP) 12 (Utility Line Activities) for impacts to “Waters of the United States”. The NWP would be a “non-reporting” permit, which means that notification will not be required. The U.S. Army Corps of Engineers (USACE) holds the final discretion as to what permits will be required for project construction and will be consulted with on final impacts and permitting requirements.

Riparian Buffers

The project occurs in both the Cape Fear River and Neuse River watersheds. Streams with buffers occur only in the Neuse River watershed, as the portion of the study area that is within the Cape Fear watershed occurs below the limits of the Jordan Lake watershed buffer. The project involves work within an existing corridor and will likely be exempt from Neuse River Riparian Rule permitting.

Federally Protected Species

As of June 27, 2018, the United States Fish and Wildlife Service (USFWS) lists six federally protected species under the Endangered Species Act (ESA) for Wake County. Due to the lack of potential impacts to threatened or endangered species, biological conclusions of “No Effect” can be reached for all of the terrestrial and aquatic species. Of those species, Michaux’s sumac (*Rhus michauxii*) required a survey during design and will require a resurvey prior to construction.

F. Project Impact Criteria Checklists:

<u>Type I & II - Ground Disturbing Actions</u>			
<u>FHWA APPROVAL ACTIVITIES THRESHOLD CRITERIA</u>			
If any of questions 1-7 are marked "yes" then the CE will require FHWA approval.		Yes	No
1	Does the project require formal consultation with U.S. Fish and Wildlife Service (USFWS) or National Marine Fisheries Service (NMFS)?	<input type="checkbox"/>	<input checked="" type="checkbox"/>
2	Does the project result in impacts subject to the conditions of the Bald and Golden Eagle Protection Act (BGPA)?	<input type="checkbox"/>	<input checked="" type="checkbox"/>
3	Does the project generate substantial controversy or public opposition, for any reason, following appropriate public involvement?	<input type="checkbox"/>	<input checked="" type="checkbox"/>
4	Does the project cause disproportionately high and adverse impacts relative to low-income and/or minority populations?	<input type="checkbox"/>	<input checked="" type="checkbox"/>
5	Does the project involve a residential or commercial displacement, or a substantial amount of right of way acquisition?	<input type="checkbox"/>	<input checked="" type="checkbox"/>
6	Does the project require an Individual Section 4(f) approval?	<input type="checkbox"/>	<input checked="" type="checkbox"/>
7	Does the project include adverse effects that cannot be resolved with a Memorandum of Agreement (MOA) under Section 106 of the National Historic Preservation Act (NHPA) or have an adverse effect on a National Historic Landmark (NHL)?	<input type="checkbox"/>	<input checked="" type="checkbox"/>
If any of questions 8 through 31 are marked "yes" then additional information will be required for those questions in Section G.			
<u>Other Considerations</u>		Yes	No
8	Does the project result in a finding of "may affect not likely to adversely affect" for listed species, or designated critical habitat under Section 7 of the Endangered Species Act (ESA)?	<input type="checkbox"/>	<input checked="" type="checkbox"/>
9	Is the project located in anadromous fish spawning waters?	<input type="checkbox"/>	<input checked="" type="checkbox"/>
10	Does the project impact waters classified as Outstanding Resource Water (ORW), High Quality Water (HQW), Water Supply Watershed Critical Areas, 303(d) listed impaired water bodies, buffer rules, or Submerged Aquatic Vegetation (SAV)?	<input checked="" type="checkbox"/>	<input checked="" type="checkbox"/>
11	Does the project impact waters of the United States in any of the designated mountain trout streams?	<input type="checkbox"/>	<input checked="" type="checkbox"/>
12	Does the project require a U.S. Army Corps of Engineers (USACE) Individual Section 404 Permit?	<input type="checkbox"/>	<input checked="" type="checkbox"/>
13	Will the project require an easement from a Federal Energy Regulatory Commission (FERC) licensed facility?	<input type="checkbox"/>	<input checked="" type="checkbox"/>
14	Does the project include a Section 106 of the NHPA effects determination other than a no effect, including archaeological remains?	<input type="checkbox"/>	<input checked="" type="checkbox"/>

<u>Other Considerations (continued)</u>		Yes	No
15	Does the project involve hazardous materials and/or landfills?	<input type="checkbox"/>	<input checked="" type="checkbox"/>
16	Does the project require work encroaching and adversely affecting a regulatory floodway or work affecting the base floodplain (100-year flood) elevations of a water course or lake, pursuant to Executive Order 11988 and 23 CFR 650 subpart A?	<input type="checkbox"/>	<input checked="" type="checkbox"/>
17	Is the project in a Coastal Area Management Act (CAMA) county and substantially affects the coastal zone and/or any Area of Environmental Concern (AEC)?	<input type="checkbox"/>	<input checked="" type="checkbox"/>
18	Does the project require a U.S. Coast Guard (USCG) permit?	<input type="checkbox"/>	<input checked="" type="checkbox"/>
19	Does the project involve construction activities in, across, or adjacent to a designated Wild and Scenic River present within the project area?	<input type="checkbox"/>	<input checked="" type="checkbox"/>
20	Does the project involve Coastal Barrier Resources Act (CBRA) resources?	<input type="checkbox"/>	<input checked="" type="checkbox"/>
21	Does the project impact federal lands (e.g. U.S. Forest Service (USFS), USFWS, etc.) or Tribal Lands?	<input type="checkbox"/>	<input checked="" type="checkbox"/>
22	Does the project involve any changes in access control?	<input type="checkbox"/>	<input checked="" type="checkbox"/>
23	Does the project have a permanent adverse effect on local traffic patterns or community cohesiveness?	<input type="checkbox"/>	<input checked="" type="checkbox"/>
24	Will maintenance of traffic cause substantial disruption?	<input type="checkbox"/>	<input checked="" type="checkbox"/>
25	Is the project inconsistent with the STIP or the Metropolitan Planning Organization's (MPO's) Transportation Improvement Program (TIP) (where applicable)?	<input type="checkbox"/>	<input checked="" type="checkbox"/>
26	Does the project require the acquisition of lands under the protection of Section 6(f) of the Land and Water Conservation Act, the Federal Aid in Fish Restoration Act, the Federal Aid in Wildlife Restoration Act, Tennessee Valley Authority (TVA), or other unique areas or special lands that were acquired in fee or easement with public-use money and have deed restrictions or covenants on the property?	<input type="checkbox"/>	<input checked="" type="checkbox"/>
27	Does the project involve Federal Emergency Management Agency (FEMA) buyout properties under the Hazard Mitigation Grant Program (HMGP)?	<input type="checkbox"/>	<input checked="" type="checkbox"/>
28	Does the project include a <i>de minimis</i> or programmatic Section 4(f)?	<input type="checkbox"/>	<input checked="" type="checkbox"/>
29	Is the project considered a Type I under the NCDOT's Noise Policy?	<input type="checkbox"/>	<input checked="" type="checkbox"/>
30	Is there prime or important farmland soil impacted by this project as defined by the Farmland Protection Policy Act (FPPA)?	<input type="checkbox"/>	<input checked="" type="checkbox"/>
31	Are there other issues that arose during the project development process that affected the project decision?	<input type="checkbox"/>	<input checked="" type="checkbox"/>

G. Additional Documentation as Required from Section F

N/A



H. Project Commitments

Wake County Fuquay-Varina Signal System Upgrade Project TIP No. U-6022

Community Resources

The project will comply with Americans with Disabilities Act (ADA) requirements and best practices for pedestrian accessibility within public rights-of-way. The NCDOT Project Manager will coordinate with the NCDOT Division of Bicycle and Pedestrian Transportation and Work Zone Safety Program to ensure that temporary and permanent improvements do not physically block pedestrian paths/ramps and that pedestrian detours or re-routing of sidewalks during construction comply with ADA standards and best practices.

Cultural Resources

If archaeological resources (Native American artifacts and/or human remains) are encountered during project construction, work will cease in that area and the NCDOT Archaeology Group and the Catawba Indian Nation will be notified immediately.

Jurisdictional Features

~~Areas where ground-disturbing activities will take place near jurisdictional waters will be delineated. The U.S. Army Corps of Engineers (USACE) will be consulted with on final impacts and permitting requirements.~~

Federally Protected Species

~~Michaux's sumac (*Rhus michauxii*) will be surveyed for prior to construction.~~

I. Categorical Exclusion Approval

STIP Project No.	<u>U-6022</u>
WBS Element	<u>47148.1.1</u>
Federal Project No.	<u>BGANY-0507(011)</u>

Prepared By:

Date Stephanie Gallagher, AICP-CEP
Atkins (Consultant)

Prepared For: North Carolina Department of Transportation

Reviewed By:

Date Eileen Fuchs, Project Manager
North Carolina Department of Transportation

Approved If all of the threshold questions (1 through 7) of Section F are answered “no,” NCDOT approves this Categorical Exclusion.

Certified If any of the threshold questions (1 through 7) of Section F are answered “yes,” NCDOT certifies this Categorical Exclusion.

Date Pam Williams, PE, Project Management Unit
North Carolina Department of Transportation

FHWA Approved: For Projects Certified by NCDOT (above), FHWA signature required.

Date John F. Sullivan, III, PE, Division Administrator
Federal Highway Administration

- Legend**
- Project Study Area
 - Parks
 - Greenways
 - Open Space

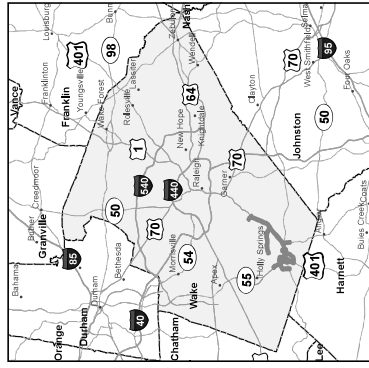

PROJECT VICINITY

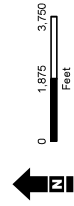

Source: ESRI, NCDOT, Wake County, NCOneMap, Town of Fuquay-Varina.

Fuquay-Varina Town-wide Closed Loop Signal System



TIP PROJECT NO. U-6022;
STATE PROJECT NO. 47148.1.1
Wake County, North Carolina

PROJECT LOCATION



Sources: Esri, HERE, Garmin, USGS, Intermap, INCREMENT P, NRCan, Esri Japan, METI, Esri China (Hong Kong), Esri Korea, Esri (Thailand), NGCC, (c) OpenStreetMap contributors, and the GIS User Community

FIGURE 1



NO ARCHAEOLOGICAL SURVEY REQUIRED FORM

This form only pertains to ARCHAEOLOGICAL RESOURCES for this project. It is not valid for Historic Architecture and Landscapes. You must consult separately with the Historic Architecture and Landscapes Group.



PROJECT INFORMATION

Project No: **U-6022** County: **Wake**
 WBS No: **47148.1.1** Document: **Federal CE**
 F.A. No: **BGANY-0507(011)** Funding: State Federal

Federal Permit Required? Yes No Permit Type: **USACE**

Project Description: The North Carolina Department of Transportation (NCDOT) Division 5 intends to improve the existing traffic signal system in the Town of Fuquay-Varina (Wake County) by constructing a Town-wide Closed Loop System. The project includes installation of 24 miles of new fiber cable (overhead and underground), 41 upgraded cabinets, and three new CCTV cameras. The project will take place primarily within existing right of way. In some locations, the improvements (poles, conduit, pull boxes) may be placed within an existing Public Utility Easement (PUE). The PUE is located between the roadway and existing poles/utilities. No new right of way or easements are required for this project. New signals will not be constructed at previously unsignalized intersections and the existing signals will be retained, where possible. This project will simply modernize the existing system. The existing cabinets will also be replaced. Whenever possible, the current location and mounting method of the existing cabinet will be maintained. Two locations have pole-mounted cabinets, and these will remain pole-mounted. The majority of the new overhead cables will be placed on existing poles. In some locations, underground cable/conduit may be required. Any underground cable/conduit will be installed with less intrusive horizontal directional drilling. In coordination with the project engineers, an area of potential effects (APE) was established for the project as described. This APE is estimated to encompass 307.4 acres (slightly more than 124.4 hectares).

SUMMARY OF CULTURAL RESOURCES REVIEW

Brief description of review activities, results of review, and conclusions:

The review of the site maps and files archived at the North Carolina Office of State Archaeology was conducted on April 16, 2019. A relatively large number of archaeological sites have been identified within a .5-mile radius of the APE as currently proposed (including, but not limited to 31WA428, 31WA946, 31WA950-953, 31WA955-956, 31WA1031, 31WA1457-1458, 31WA1477, 31WA1821-1822, 31WA1825-1826, 31WA1828-1831, 31WA1838-1839, 31WA1851, 31WA1853, 31WA1860-1861, 31WA1863-1864, 31WA1865, 31WA1879, 31WA1888, 31WA1891, 31WA1900, 31WA1954, 31WA198531WA2132, 31WA2134, 31WA2015-2017).

Archaeological investigations were undertaken along a segment of the current APE as part of the widening of US 401 between NC 55 and SR 2753 (Robinson 1991). Five archaeological sites were identified through archaeological survey along US 401. Four of these sites were characterized as plow-disturbed scatters of prehistoric materials (some with a handful of historic materials as well). The remaining site, 31WA953, was identified as a scatter of late-nineteenth or early twentieth century artifacts associated with a small residence. None of these sites were considered to be archaeologically significant.

Under the auspices of the 2009 Programmatic Agreement between the United States Federal Highway Administration, the North Carolina State Historic Preservation Office, and NCDOT, a review of the proposed replacement of Bridge No. 444, on Wade Nash Road to the west of the current APE was conducted by NCDOT staff archaeologist, Damon Jones. While he noted archaeological resources in the vicinity along the unnamed tributary to Basal Creek, Jones determined that the proposed project was unlikely to significantly impact archaeological resources outside the disturbed areas along SR 1113. A No Survey Required form was issued on December 9, 2011 (PA No. 11-11-0052).

In 2017, researchers on staff with Archaeological Consultants of the Carolinas, Inc., investigated a 78-acre tract slated for development along SR 1393, Hilltop Needmore Road (Parker and Reid 2017). Five sites were investigated in their project area including three multi-component scatters of material that were not considered to be archaeologically significant (31WA2014-2015, 31WA2017). A collection of historic-period (nineteenth and twentieth century) structures associated with a farmstead on the property was designated site 31WA2016, but was not considered to be eligible for the National Register of Historic Places (NRHP). One site, 31WA1865, with Early Archaic and Early/Middle Woodland components, was considered to exhibit enough evidence for further investigation before determining NRHP-significance, and thus, remained unassessed at the end of the 2017 study.

An examination of the data presented on the North Carolina State Historic Preservation Office HPOWEB GIS Service (<http://gis.ncdcr.gov/hpoweb/>) reveals a large number of recorded historic property locations within .5-mile of the proposed project. Most of the historic properties within this radius are associated with resources listed on the NRHP including: the Dr. L. J. Faulhaber Farm (WA4811); the J. Beal Johnson House (WA0566); the Jones-Johnson-Ballentine Historic District (WA0723); the Kemp B. Johnson House (WA0567); the Fuquay-Varina Woman's Club Clubhouse (WA4420); the Fuquay Springs High School (WA0486); the Fuquay Springs Teacherage (WA4422); the Fuquay Springs Historic District (WA4076; WA7248); and the Brown Tobacco Company Redrying & Storage Facility (WA6544). While a large number of historic properties that are not associated with the previously mentioned historic districts within a .5-mile radius of the proposed project, a few are located in the immediate vicinity to the project footprint including: the former location of McCullers Crossroads (WA1237); historic houses and former house locations (WA0464-0468, WA0471, WA0482, WA0497-0498, WA0524, WA0555, WA0560, WA1118, WA1229, WA7106-7110, WA4772, WA6538, WA-R145), the James Suggs House (0591); a historic store (WA0594); Yancey Farm (WA0589); the Edward-Sexton House (WA0573); the Rufus and Lena Sexton House (WA0572); the former location of the Archie Johnson House (WA0568); a historic farm (WA0587); the Varina Knitting Company (WA0472); the Farmers Exchange Commission Building (WA0476); the Weaver House (WA0469); Ann Aikens House (WA0470); the Norfolk and Southern Depot (WA0452); Union Station (Durham and Southern Depot) (WA0451); Lindsay Heights (WA6534); Fuquay Varina Methodist Church (WA4206); Chevrolet Auto Dealership Building (WA0519); Ford Auto Dealership Building (WA0504); Commercial Buildings (WA0495-0496); and the Geraldine and Roy Tilley House (WA4852). Adjacent cemeteries include Stephen's Cemetery, the Smith-Sexton Family Cemetery, the Arthur Norris Family Cemetery, St. Augusta's Cemetery, Greenlawn Memorial Cemetery, and the Utley-Nash Family Cemetery.

An examination of soils in Wake County presented on the National Resources Conservation Service Web Soil Survey (<http://websoilsurvey.nrcs.usda.gov/app/WebSoilSurvey.aspx>) indicates that the following soil types fall within the delineated APE: Altavista fine sandy loam, 0 to 4 percent slopes, rarely flooded (AaA); Bibb sandy loam, 0 to 2 percent slopes, frequently flooded (BbA); Cecil sandy loam, 6 to 10 percent slopes (CeC); Cecil-Urban land complex, 2 to 10 percent slopes (CfC); Chewacla and Wehadkee soils, 0 to 2 percent slopes, frequently flooded (ChA); Dothan loamy sand, 0 to 2 percent slopes (DoA); Dothan loamy sand, 2 to 6 percent slopes (DoB); Dothan-Urban land complex, 0 to 6 percent slopes (DuB); Fuquay loamy sand, 0 to 6 percent slopes (FrB); Fuquay-Urban land complex, 0 to 6 percent slopes (FuB); Goldsboro sandy loam, 0 to 2 percent slopes (GoA); Gritney sandy loam, 6 to 10 percent slopes (GrC); Nanford silt loam, 15 to 25 percent slopes (NaE); Pacolet sandy loam, 6 to 10 percent

19-04-0015

slopes (PaC); Pacolt sandy loam, 10 to 15 percent slopes (PaD); Pacolt sandy loam, 15 to 25 percent slopes (PaE); Pacolt-Urban land complex, 10 to 15 percent slopes (PbD); Rains sandy loam, 0 to 2 percent slopes (RaA); Urban land (Ur); and Wedowee sandy loam, 10 to 15 percent slopes (WeD).

No further archaeological investigations are required for the project within the area established as the APE for the project as it is currently described. Should the project change to expand outside existing disturbed ROW or the existing easements for power-lines, further review will be necessary. In the unlikely event that archaeological remains are encountered during the highway widening, work should cease in that area and the NCDOT Archaeology Group should be notified immediately.

Brief Explanation of why the available information provides a reliable basis for reasonably predicting that there are no unidentified historic properties in the APE:

A large number of archaeological resources and historic properties have been documented in the vicinity of the proposed project, as has been briefly sketched above. But, the vast majority of the proposed project includes installing cables, cabinets, or cameras within existing disturbed ROW. Much of these additions will be run as overhead cables and will include no ground disturbance. In a few locations underground cable will be added within existing disturbed ROW. In areas where no ROW is available, poles, conduit, and pull boxes will be placed within existing PUE. Thus, even in the proximity of known archaeological and historic resources, the project will not extend outside areas that have been severely disturbed by previous construction, maintenance and utilities work. No archaeological sites of significance are expected to be impacted by the project as currently proposed.

References Cited:

Parker, K. and D. Reid

2017 *Phase I Archaeological Investigations in the Proposed Falco Development Tract, Wake County, North Carolina*. Ms. On file, Office of State Archaeology, North Carolina Department of Natural and Cultural Resources, Raleigh.

Robinson, K. W.

1991 *Archaeological Study, Widening of US 401 from NC 42-55 to SR 2753, Fuquay-Varina, Wake County, North Carolina, TIP No. 2416*. MS. On file, Environmental Analysis Unit, North Carolina Department of Transportation, Raleigh.

SUPPORT DOCUMENTATION

See attached: Map(s) Previous Survey Info Photos Correspondence
 Other: soil map, cable layout mapping, signal system overview map

FINDING BY NCDOT ARCHAEOLOGIST

NO ARCHAEOLOGY SURVEY REQUIRED



NCDOT ARCHAEOLOGIST

June 4, 2019

Date

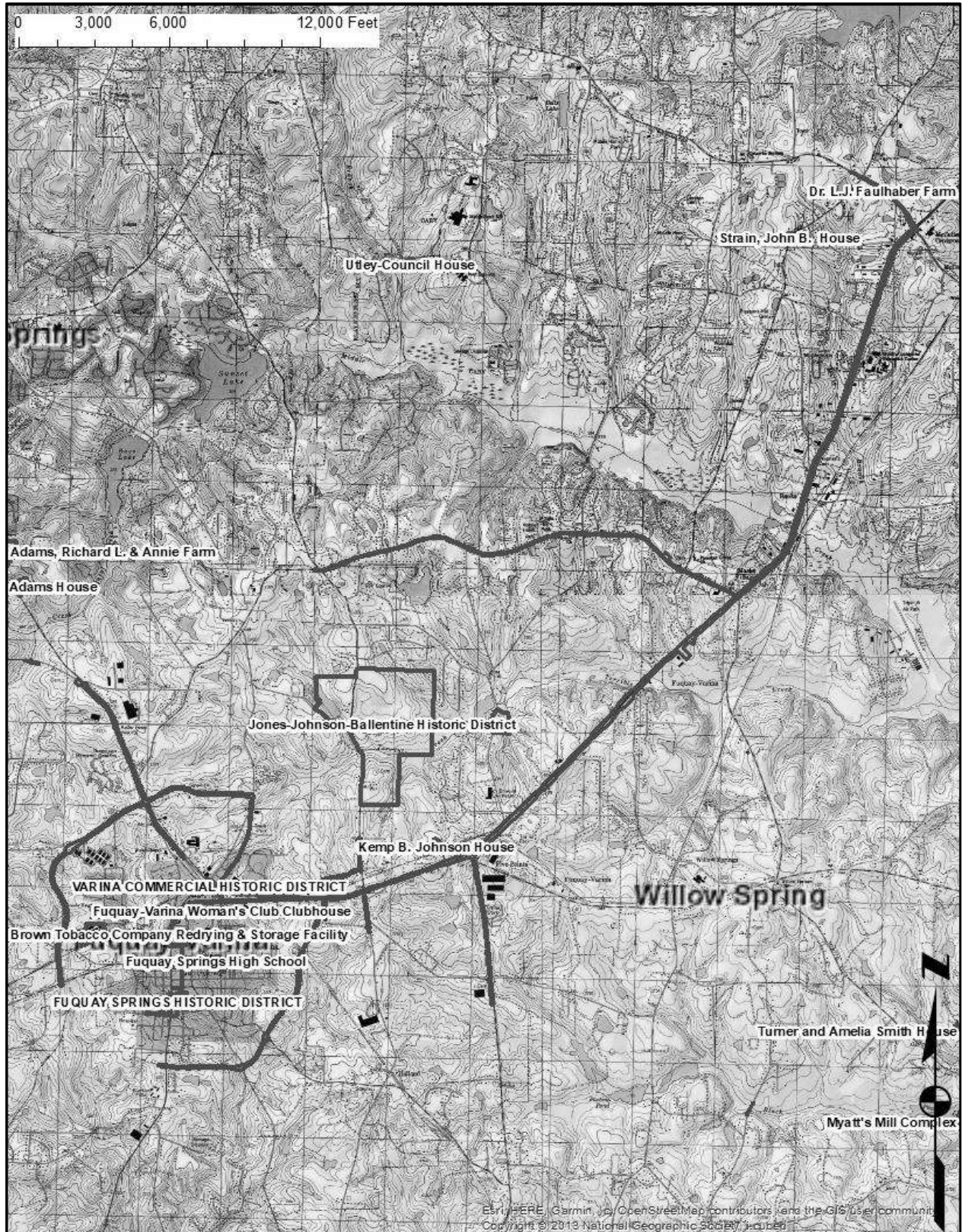

Detail of the Angier, Apex, Fuquay-Varina, and Lake Wheeler NC 7.5-minute topographic maps illustrating the location of the proposed closed loop traffic signal system (red lines); note the location of NRHP-listed historic districts and properties (blue lines).

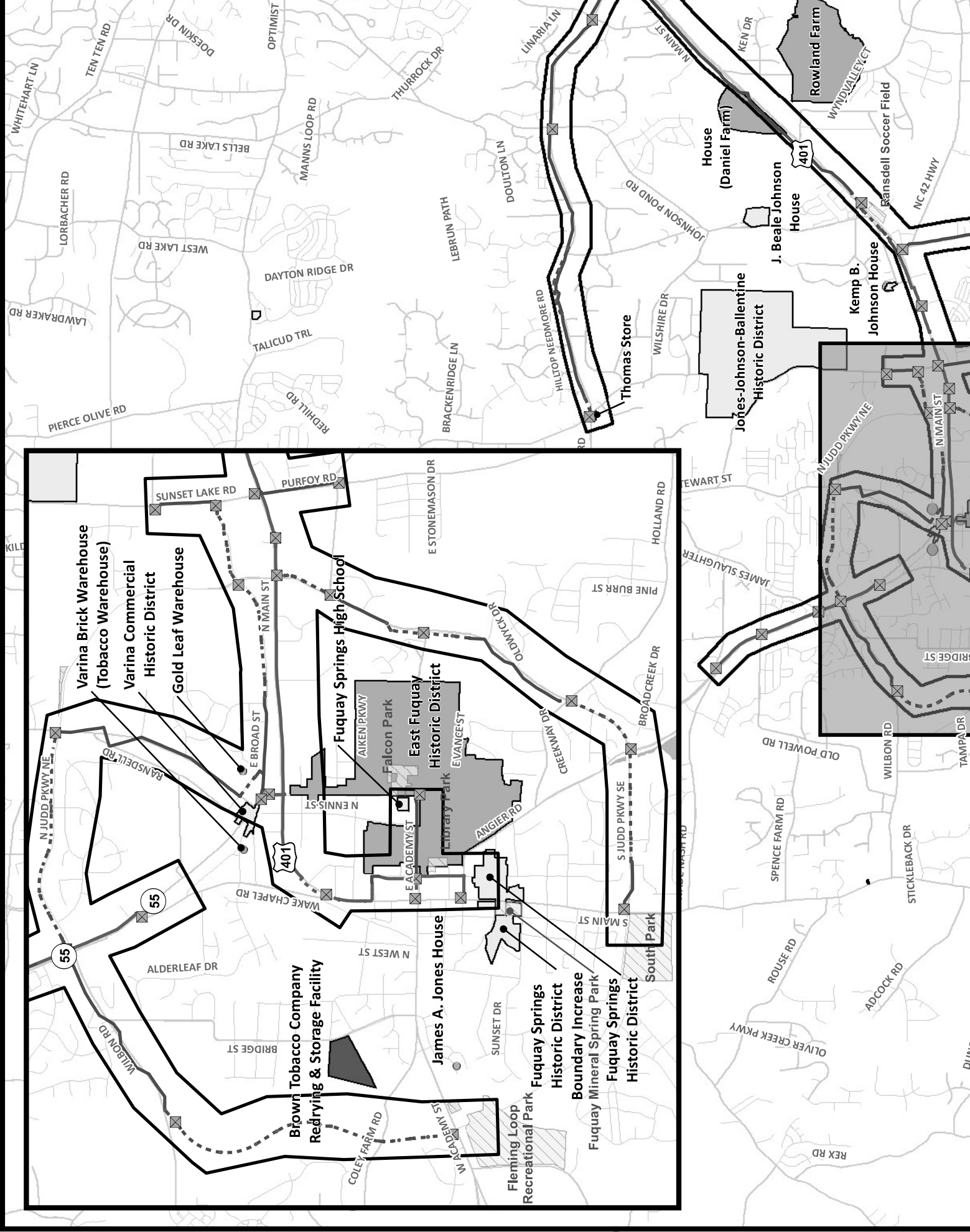

Varina Brick Warehouse
(Tobacco Warehouse)

Varina Commercial
Historic District

Gold Leaf Warehouse

Fuquay Springs High School

Falcon Park
East Fuquay
Historic District

James A. Jones House

Fleming Loop
Recreational Park

Fuquay Springs
Boundary Increase
Historic District

Fuquay Mineral Spring Park
Historic District

South Park

Thomas Store

Jones-Johnson-Ballentine
Historic District

House
(Daniel Farm)

J. Beale Johnson
House

Kemp B.
Johnson House

Rowland Farm

Pierce Olive Rd

Lawdraker Rd

West Lake Rd

Bells Lake Rd

Dayton Ridge Dr

Talucud Trl

Manns Loop Rd

Thurrock Dr

Brackenridge Ln

Lebrun Path

Douilton Ln

Linaria Ln

Hilltop Needmore Rd

Johnson Pond Rd

Wilshire Dr

Ken Dr

Wynd Valley Ct

Ransdell Soccer Field

NC 42 Hwy

Sunset Lake Rd

Purfoy Rd

N Main St

E Stonemason Dr

Oldmck Dr

Creman Dr

Evangest

Angier Rd

S Judd Pkwy SE

Broad Creek Dr

Holland Rd

Ewart St

Pine Burr St

James Slaughter

Old Powell Rd

Wilbon Rd

Tampa Dr

Alderleaf Dr

Bridge St

N West St

Wake Chapel Rd

Academy St

Trotary Park

Academy St

Sunset Dr

S Main St

Wake Chapel Rd

Wake Chapel Rd

Wake Chapel Rd

Wake Chapel Rd

Wake Chapel Rd

Wake Chapel Rd

Wake Chapel Rd

Wake Chapel Rd

Wake Chapel Rd

Wake Chapel Rd

Coley Farm Rd

Academy St

Academy St

Academy St

Academy St

Academy St

Academy St

Academy St

Academy St

Academy St

Academy St

Academy St

Academy St

Academy St

Academy St

Academy St

Academy St

Academy St

Academy St

Academy St

Academy St

Academy St

Academy St

Academy St

Academy St

Academy St

Academy St

Academy St

Academy St

Academy St

Academy St

Academy St

Academy St

Academy St

Academy St

Academy St

Academy St

Academy St

Academy St

Academy St

Academy St

Academy St

Academy St

Academy St

Academy St

Academy St

Academy St

Academy St

Academy St

Academy St

Academy St

Academy St

Academy St

Academy St

Academy St

Academy St

Academy St

Academy St

Academy St

Academy St

Academy St

Academy St

Academy St

Academy St

Academy St

Academy St

Academy St

Academy St

Academy St

Academy St

Academy St

Academy St

Academy St

Academy St

Academy St

Academy St

Academy St

Academy St

Academy St

Academy St

Academy St

Academy St

Academy St

Academy St

Academy St

Academy St

Academy St

Academy St

Academy St

Academy St

Academy St

Academy St

Academy St

Academy St

Academy St

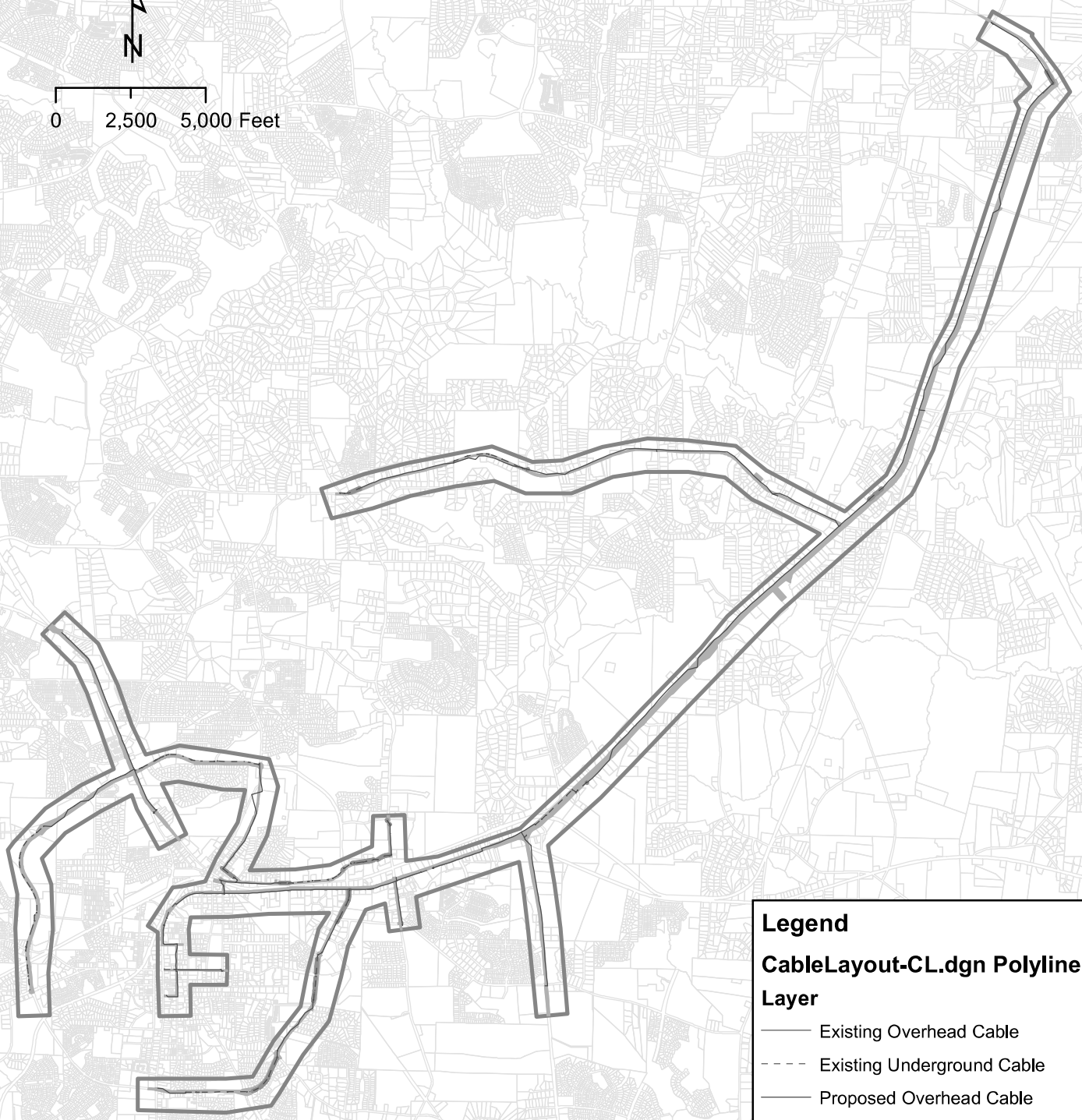
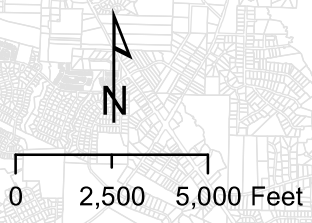

Legend

CableLayout-CL.dgn Polyline Layer

- Existing Overhead Cable
- - - Existing Underground Cable
- Proposed Overhead Cable
- - - Proposed Underground Cable

U6022_ArchaeologyStudyLimits Type

- Existing Right of Way
- PUE Encroachment
- Project Study Area
- Parcels (01-30-2019)

**ARCHAEOLOGY STUDY LIMITS
RECORD DRAWING**







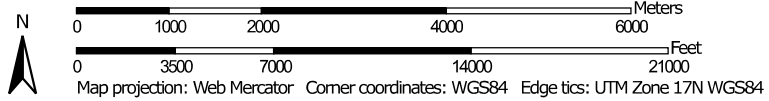





























Soil Map—Wake County, North Carolina
(ITS/Signal System in Fuquay Varina)



Map Scale: 1:81,900 if printed on A portrait (8.5" x 11") sheet.



MAP LEGEND

 Area of Interest (AOI)	 Spoil Area
 Soils	 Stony Spot
 Soil Map Unit Polygons	 Very Stony Spot
 Soil Map Unit Lines	 Wet Spot
 Soil Map Unit Points	 Other
Special Point Features	 Special Line Features
 Blowout	Water Features
 Borrow Pit	 Streams and Canals
 Clay Spot	Transportation
 Closed Depression	 Rails
 Gravel Pit	 Interstate Highways
 Gravelly Spot	 US Routes
 Landfill	 Major Roads
 Lava Flow	 Local Roads
 Marsh or swamp	Background
 Mine or Quarry	 Aerial Photography
 Miscellaneous Water	
 Perennial Water	
 Rock Outcrop	
 Saline Spot	
 Sandy Spot	
 Severely Eroded Spot	
 Sinkhole	
 Slide or Slip	
 Sodic Spot	

MAP INFORMATION

The soil surveys that comprise your AOI were mapped at 1:24,000.

Please rely on the bar scale on each map sheet for map measurements.

Source of Map: Natural Resources Conservation Service
Web Soil Survey URL:
Coordinate System: Web Mercator (EPSG:3857)

Maps from the Web Soil Survey are based on the Web Mercator projection, which preserves direction and shape but distorts distance and area. A projection that preserves area, such as the Albers equal-area conic projection, should be used if more accurate calculations of distance or area are required.

This product is generated from the USDA-NRCS certified data as of the version date(s) listed below.

Soil Survey Area: Wake County, North Carolina
Survey Area Data: Version 17, Sep 10, 2018

Soil map units are labeled (as space allows) for map scales 1:50,000 or larger.

Date(s) aerial images were photographed: Feb 14, 2011—Dec 9, 2017

The orthophoto or other base map on which the soil lines were compiled and digitized probably differs from the background imagery displayed on these maps. As a result, some minor shifting of map unit boundaries may be evident.

Map Unit Legend

Map Unit Symbol	Map Unit Name	Acres in AOI	Percent of AOI
AaA	Altavista fine sandy loam, 0 to 4 percent slopes, rarely flooded	0.1	0.0%
BbA	Bibb sandy loam, 0 to 2 percent slopes, frequently flooded	10.1	3.3%
CeC	Cecil sandy loam, 6 to 10 percent slopes	1.0	0.3%
CfC	Cecil-Urban land complex, 2 to 10 percent slopes	4.2	1.4%
ChA	Chewacla and Wehadkee soils, 0 to 2 percent slopes, frequently flooded	5.0	1.6%
DoA	Dothan loamy sand, 0 to 2 percent slopes	3.2	1.0%
DoB	Dothan loamy sand, 2 to 6 percent slopes	17.1	5.6%
DuB	Dothan-Urban land complex, 0 to 6 percent slopes	24.7	8.0%
FrB	Fuquay loamy sand, 0 to 6 percent slopes	40.5	13.2%
FuB	Fuquay-Urban land complex, 0 to 6 percent slopes	26.5	8.6%
GoA	Goldsboro sandy loam, 0 to 2 percent slopes	0.3	0.1%
GrC	Gritney sandy loam, 6 to 10 percent slopes	15.3	5.0%
NaE	Nanford silt loam, 15 to 25 percent slopes	0.6	0.2%
PaC	Pacolet sandy loam, 6 to 10 percent slopes	2.6	0.9%
PaD	Pacolet sandy loam, 10 to 15 percent slopes	1.6	0.5%
PaE	Pacolet sandy loam, 15 to 25 percent slopes	8.3	2.7%
PbD	Pacolet-Urban land complex, 10 to 15 percent slopes	0.3	0.1%
RaA	Rains sandy loam, 0 to 2 percent slopes	4.6	1.5%
Ur	Urban land	141.1	45.9%
WeD	Wedowee sandy loam, 10 to 15 percent slopes	0.1	0.0%
Totals for Area of Interest		307.4	100.0%

19-04-0015



HISTORIC ARCHITECTURE AND LANDSCAPES NO HISTORIC PROPERTIES PRESENT OR AFFECTED FORM

This form only pertains to Historic Architecture and Landscapes for this project. It is not valid for Archaeological Resources. You must consult separately with the Archaeology Group.

PROJECT INFORMATION

Project No:	U-6022	County:	Wake
WBS No.:	47148.1.1	Document Type:	CE
Fed. Aid No:	BGANY-0507(011)	Funding:	<input type="checkbox"/> State <input checked="" type="checkbox"/> Federal
Federal Permit(s):	<input checked="" type="checkbox"/> Yes <input type="checkbox"/> No	Permit Type(s):	USACE
<u>Project Description:</u> Update ITS/Signal System in Town of Fuquay Varina			

SUMMARY OF HISTORIC ARCHITECTURE AND LANDSCAPES REVIEW

- There are no National Register-listed or Study Listed properties within the project's area of potential effects.
- There are no properties less than fifty years old which are considered to meet Criteria Consideration G within the project's area of potential effects.
- There are no properties within the project's area of potential effects.
- There are properties over fifty years old within the area of potential effects, but they do not meet the criteria for listing on the National Register.
- There are no historic properties present or affected by this project. (Attach any notes or documents as needed.)

Date of field visit: n/a

Description of review activities, results, and conclusions:

Review of HPO quad maps, relevant background reports, historic designations roster, and indexes was undertaken on April 18, 2019. The updates will take place in the vicinity of the Varina Commercial Historic District (WA1195) and Fuquay Springs Teacherage (WA4422). The project will replace an existing pole with a pole that will be 5 feet taller at the intersection of Broad and North Ennis Streets. The pole is located just outside the district but visible from within the boundary. A pole mounted signal box in front of the Fuquay Springs Teacherage will be replaced with a pole mounted signal box of the same size. Neither the new pole nor the replaced signal box will change the characteristics of the district or the teacherage that make them eligible for NR listing. No historic properties will be affected by this project.

SUPPORT DOCUMENTATION

Map(s) Previous Survey Info. Photos Correspondence Design Plans
FINDING BY NCDOT ARCHITECTURAL HISTORIAN

Historic Architecture and Landscapes – **NO HISTORIC PROPERTIES PRESENT OR AFFECTED**

Shelby Reap
NCDOT Architectural Historian

Aug. 19, 2019
Date



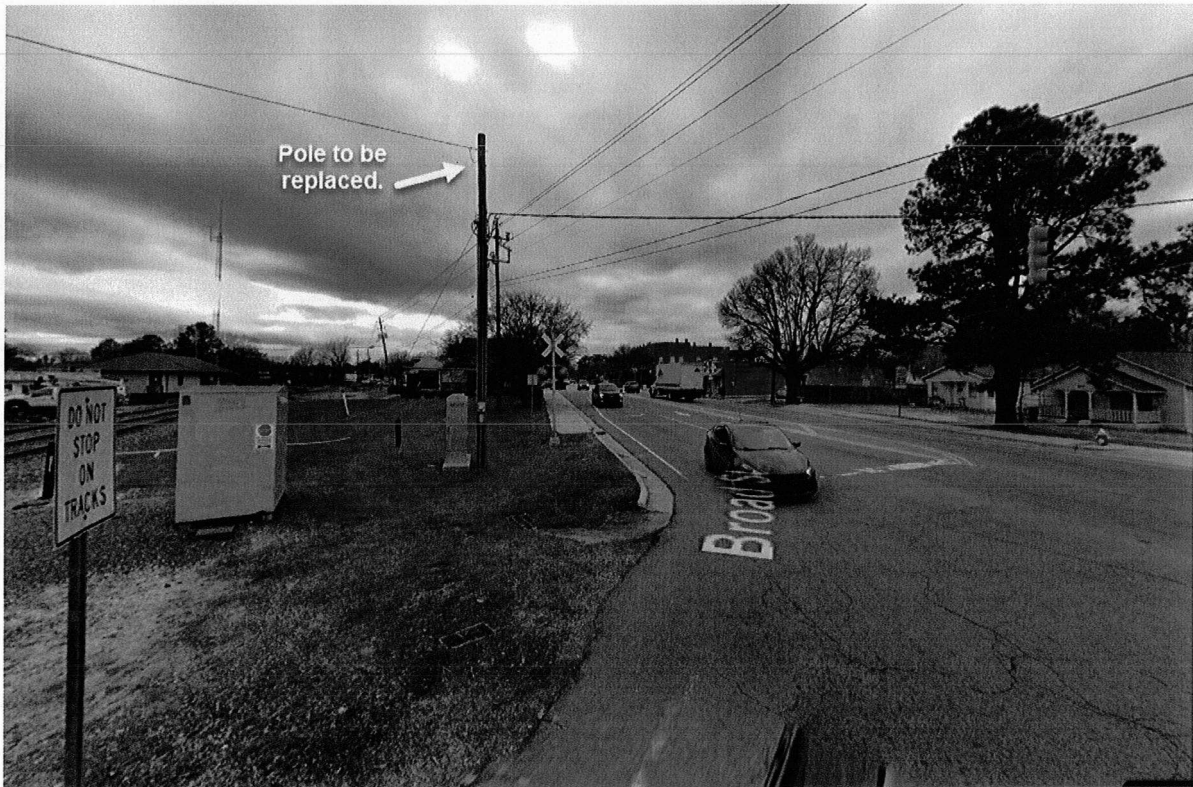

Varina Commercial Historic District (WA1195)

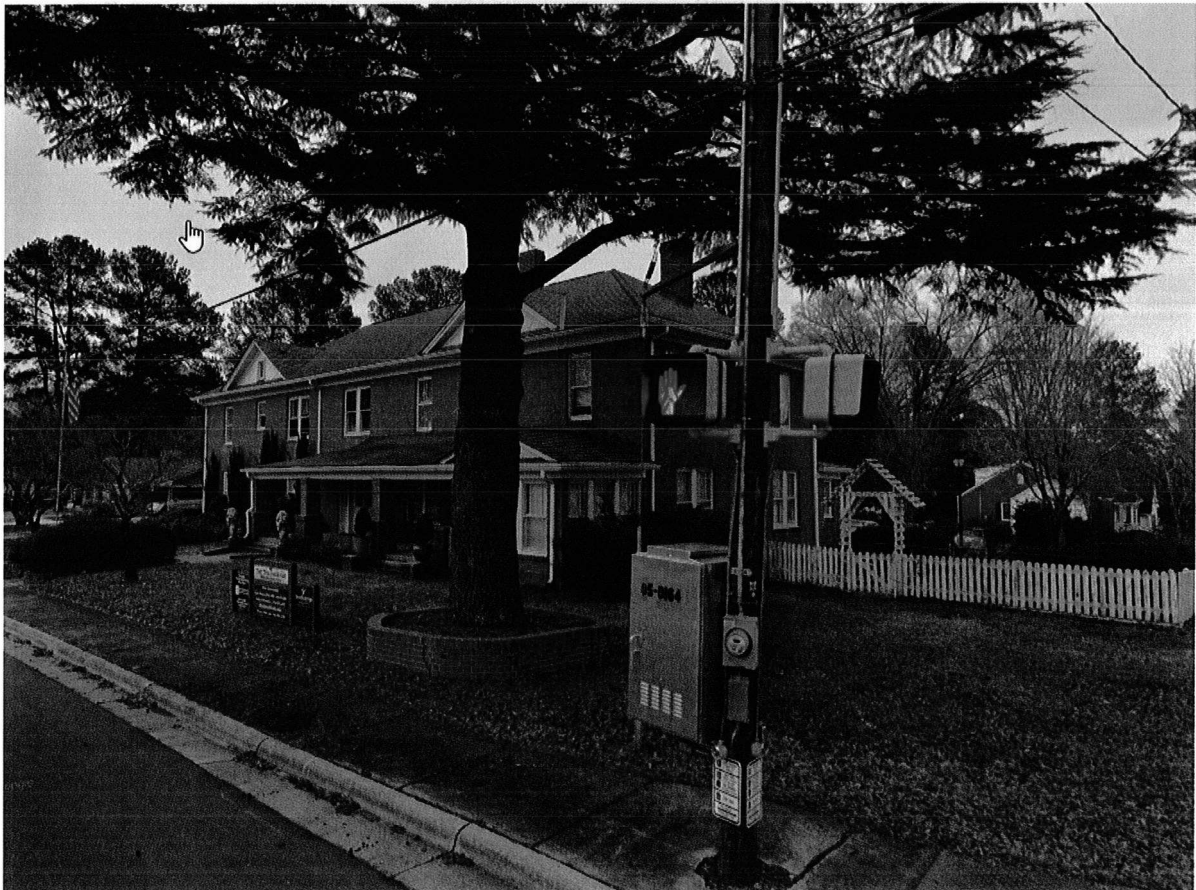

Fuquay Springs Teacherage (WA4422)

Historic Architecture and Landscapes NO HISTORIC PROPERTIES PRESENT OR AFFECTED form for Minor Transportation Projects as Qualified in the 2007 Programmatic Agreement.

U6022_SigSys_MapC.mxd JUN 05 01 2019

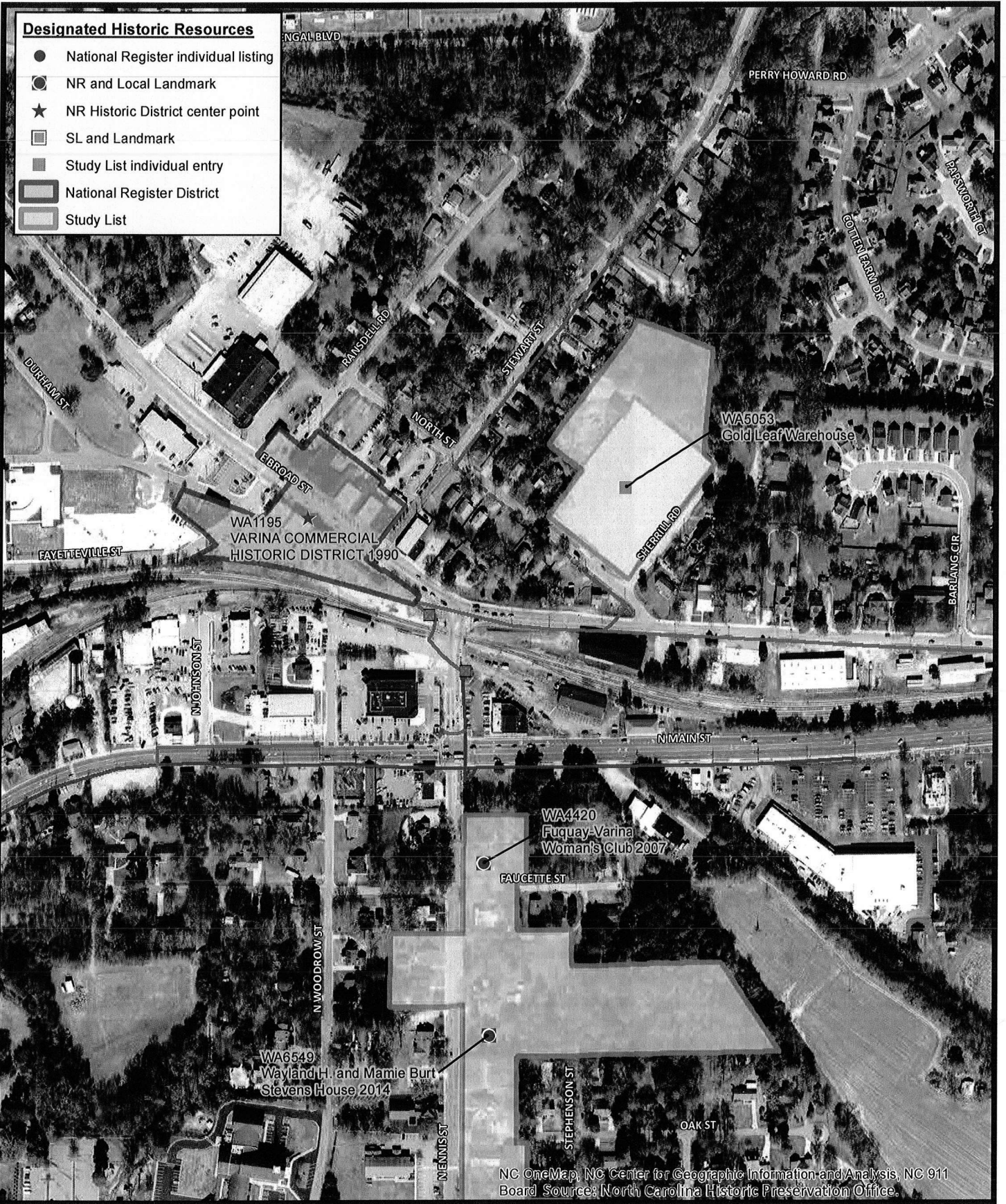

NC OneMap, NC Center for Geographic Information and Analysis, NC 911 Board Source: North Carolina Historic Preservation Office.



TIP PROJECT NO. U-6022;
STATE PROJECT NO. 47148.1.1
Wake County, North Carolina

Fuquay-Varina Town-wide Closed Loop Signal System

Legend

	Upgraded Signal Cabinet		Proposed Overhead Cable
	Existing Overhead Cable		Proposed Underground Cable
	Existing Underground Cable		Parks

HISTORIC RESOURCES

MAP C

U6022_SigSys_MapB.mxd JUN 05 01 2019

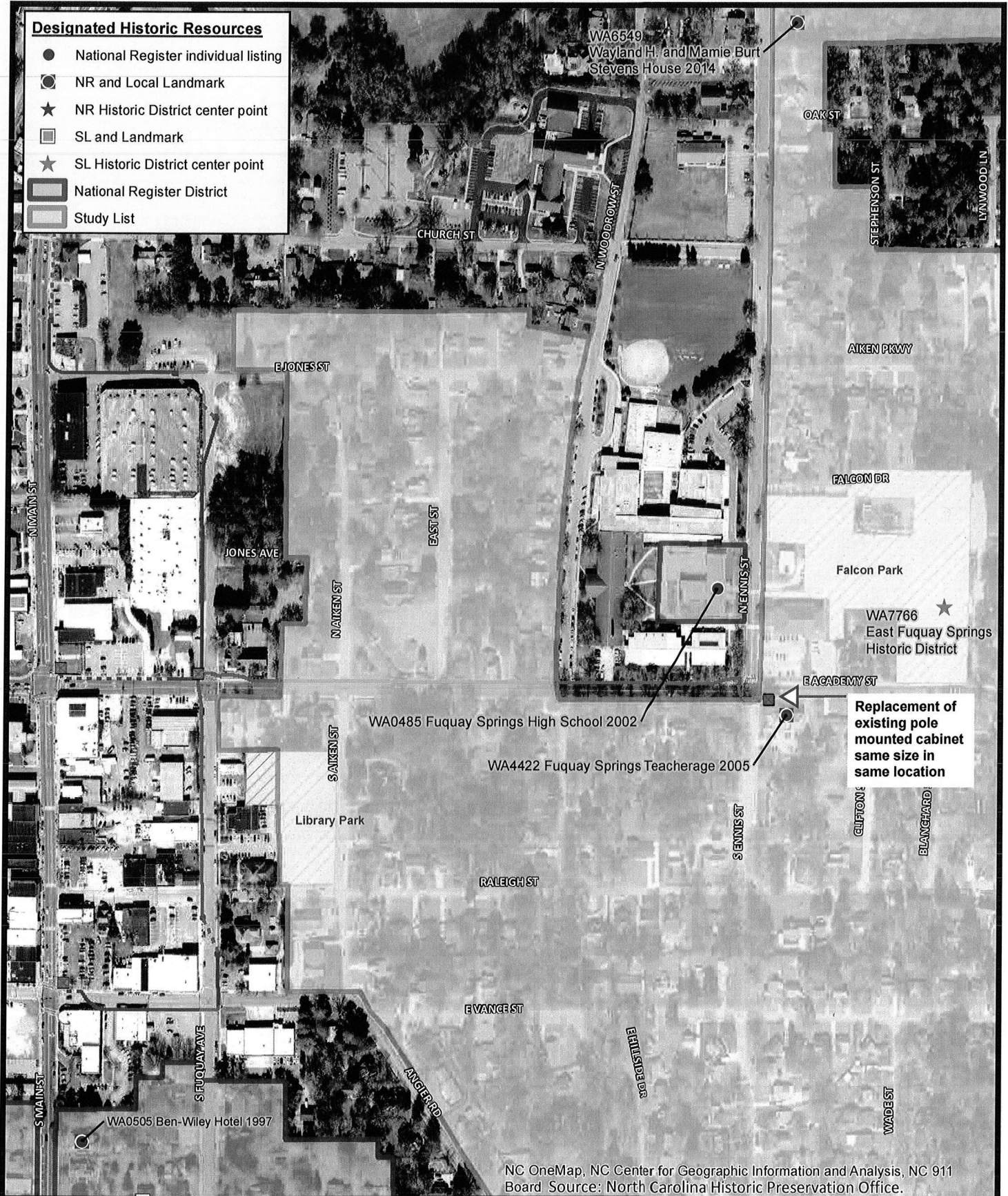

NC OneMap, NC Center for Geographic Information and Analysis, NC 911 Board Source: North Carolina Historic Preservation Office.



TIP PROJECT NO. U-6022;
STATE PROJECT NO. 47148.1.1
Wake County, North Carolina
**Fuquay-Varina Town-wide
Closed Loop Signal System**

Legend	
	Upgraded Signal Cabinet
	Existing Overhead Cable
	Existing Underground Cable
	Proposed Overhead Cable
	Proposed Underground Cable
	Parks

HISTORIC RESOURCES

MAP B

U6022_SigSys_MapA.mxd JNL 05.01.2019

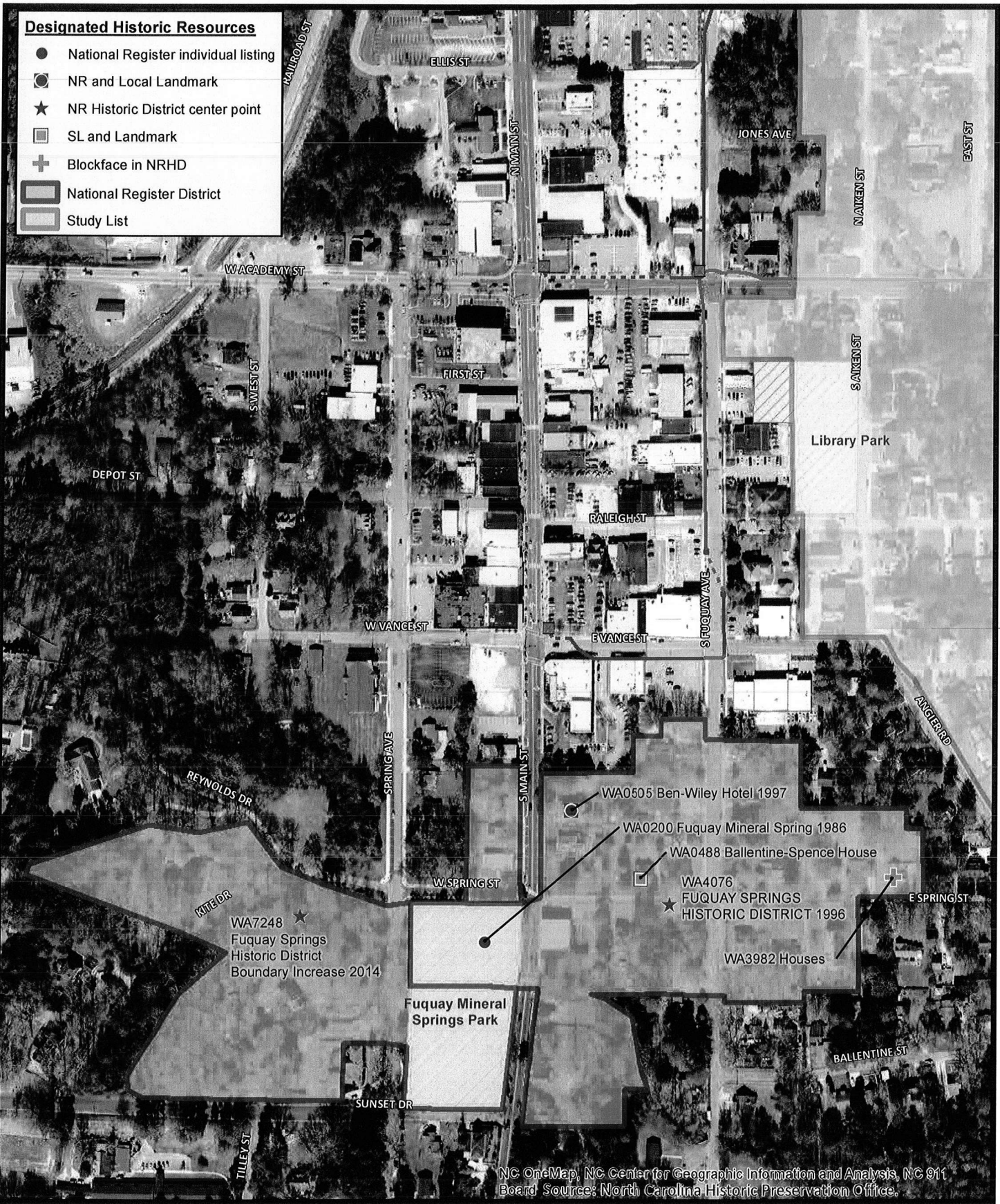

NC OneMap, NC Center for Geographic Information and Analysis, NC 911 Board Source: North Carolina Historic Preservation Office.

Designated Historic Resources

- National Register individual listing
- ⊙ NR and Local Landmark
- ★ NR Historic District center point
- ⊠ SL and Landmark
- ⊕ Blockface in NRHD
- ▭ National Register District
- ▭ Study List

Legend

- ⊠ Upgraded Signal Cabinet
- Existing Overhead Cable
- Existing Underground Cable
- Proposed Overhead Cable
- Proposed Underground Cable
- ▨ Parks

HISTORIC RESOURCES

MAP A



TIP PROJECT NO. U-6022;
STATE PROJECT NO. 47148.1.1
Wake County, North Carolina
**Fuquay-Varina Town-wide
Closed Loop Signal System**

Gerald Cochran/McCuller's Pines/Daniel Farm – Historic Resources/Eligible/Study

Corridor Construction Activities

Corridor	Cable Routing
<p>WA7107 Gerald Cochran House (Eligible) 8305 Fayetteville Rd., Fuquay-Varina (Fig.1)</p>	<p>New overhead fiber will enter from the north along the west side of Fayetteville Road, will be lashed to existing communications cable, and will be attached to existing utility poles. From this point, the fiber continues along the west side of Fayetteville Road to a point beyond the historic resource. One down guy will be installed on an existing utility pole. This work will be across the street from the historic resource and within existing right of way/easements.</p>

Corridor Construction Activities

Corridor	Cable Routing
<p>WA7794 McCuller's Pines Historic District (Study List) Fayetteville Rd. (Fig.1)</p>	<p>New overhead fiber will enter from the north along the west side of Fayetteville Road. It will be lashed to existing cable on existing utility poles through the District.</p>

Corridor Construction Activities

Corridor	Cable Routing
<p>WA118 Daniel Farm (Study List) 2601 N Main St., Willow Springs (Fig.1)</p>	<p>New underground fiber will enter from the northeast along the west side of North Main Street. The cable continues to the driveway at 2437 North Main Street where it routes through a new riser to new overhead fiber that will be lashed to new messenger cable and attached to existing utility poles. From this point, the new overhead fiber, lashed to new messenger cable, will continue along the west side of North Main Street. Two new down guys will be installed on existing utility poles. This work will be adjacent to the District/resource and within existing right of way/easements.</p>

Varina Commercial Historic District – National Register

Intersection Construction Activities

Intersection	Communications Cable Routing	Pole Work	Cabinet and Foundation Work
<p>WA1195 Varina Commercial Historic District (National Register) 1990 Broad and North Ennis Streets Fuquay-Varina (Map C)</p>	<p>The new overhead fiber, lashed to new messenger cable, will come from the east on existing utility poles along the south side of Broad Street, east of the District. The fiber will cross North Ennis Street and then route to the new utility pole located on the southwest quadrant and through a new riser to the base-mounted signal cabinet. This work will be east of this District.</p>	<p>One new pole with down guy will be installed.</p>	<p>The existing base-mounted signal cabinet in the southwest quadrant will be removed and replaced with a new base-mounted cabinet (24" w x 20" d x 78" h) in the same location.</p>
<p>WA1195 Varina Commercial Historic District (National Register) 1990 North Main and North Ennis Streets Fuquay-Varina (Map C)</p>	<p>The new overhead fiber, lashed to existing communications cable, will come from the south on existing utility poles along the east side of North Ennis Street, south of the District. The fiber will route to the existing utility pole located on the northeast quadrant and through an existing riser to the base-mounted signal cabinet. This work will be south of this District.</p>	<p>No new poles will be installed.</p>	<p>The existing base-mounted signal cabinet in the northeast quadrant will be removed and replaced with a new base-mounted cabinet (24" w x 20" d x 78" h) in the same location.</p>

Corridor Construction Activities

Corridor	Cable Routing
<p>WA1195 Varina Commercial Historic District (National Register) 1990 Broad, North, Stewart, and North Main Streets Fuquay-Varina (Map C)</p>	<p>New overhead fiber will enter from the northeast along the east side of Stewart Street, will be lashed to new communications cable, and will be attached to existing utility poles. The cable continues to North Street where it crosses North Street and then routes through a new riser to new underground conduit and heads southeast along the south side of North Street. Approximately 200 feet before North Street intersects with Broad Street, the cable routes through a new riser to new overhead fiber that will be lashed to new communications cable and attached to existing utility poles. The cable continues along the south side of North Street and then crosses Broad Street. An aerial splice enclosure will be installed on the south side of Broad Street, and the new cables, lashed to new messenger cable, will be routed to the east and west along the south side of Broad Street as well as to the southwest quadrant of the intersection of Broad Street and North Ennis Street. From this point, the eastbound fiber continues east along the south side of Broad Street to a point beyond the District. After crossing Broad Street, the westbound cable continues west along the south side of Broad Street until it crosses North Ennis Street. Then the cable, lashed to new messenger cable, turns to the south and crosses the Norfolk Southern Railroad tracks along the west side of North Ennis Street before crossing over North Ennis Street again. From this point, the new overhead fiber, lashed to existing communications cable, will continue south along the east side of North Ennis Street. An aerial splice enclosure will be installed, and the new cables will be routed to the east along the south side of North Main Street and lashed to the existing messenger cable, located west along the north side of North Main Street and lashed to new messenger cable, as well as to the northeast quadrant</p>



Varina Commercial Historic District – National Register

of the intersection of North Main Street and North Ennis Street. From this point, the eastbound fiber continues east along the south side of North Main Street to a point beyond the District. The new westbound fiber, lashed to new messenger cable, turns west and crosses over North Ennis Street and routes through a new riser to new underground conduit. From this point, the westbound fiber continues along the north side of North Main Street to a point beyond the District. Four down guys will be installed on existing utility poles. This work will be adjacent to the District within existing right of way/easements.

Gold Leaf Warehouse – Historic Resource/Study

Corridor Construction Activities

Corridor	Cable Routing
<p>WAS053 Gold Leaf Warehouse (Study List) 609 North St., Fuquay-Varina (Map C)</p>	<p>New overhead fiber will enter from the northeast along the east side of Stewart Street. It will be lashed to new messenger cable and will be attached to existing utility poles. The cable continues until North Street where it crosses North Street and then routes through a new riser to new underground conduit and heads southeast along the south side of North Street. Approximately 200 feet before North Street intersects with Broad Street, the cable routes through a new riser to new overhead fiber that will be lashed to new messenger cable and attached to existing utility poles. The cable continues along the south side of North Street and then crosses Broad Street. An aerial splice enclosure will be installed on the south side of Broad Street, and the new cables, lashed to new messenger cable, will be routed to the east and west along the south side of Broad Street as well as to the southwest quadrant of the intersection of Broad Street and North Ennis Street. From this point, the eastbound fiber continues east along the south side of Broad Street to a point beyond the District and the westbound cable continues west along the south side of Broad Street to a point beyond the District. Three down guys will be installed on existing utility poles. This work will be adjacent to the District within existing right of way/easements.</p>

East Fuquay Springs Historic District – Historic Resource/Study

Intersection Construction Activities

Intersection	Communications Cable Routing	Pole Work	Cabinet and Foundation Work
<p>WA7766 East Fuquay Springs Historic District (Study List) (2016 East Academy Street and Ennis Street (Map B))</p>	<p>The new overhead fiber, lashed to new messenger cable, will come from the west on existing utility poles along the north side of East Academy Street. The fiber will be spliced overhead and the new cable crosses East Academy Street just west of Ennis Street and then crosses Ennis Street just south of East Academy Street. The fiber will route down the utility pole at the signal cabinet, located in the southeast quadrant, through a new riser to the pole-mounted signal cabinet. This work will be adjacent to and inside this District.</p>	<p>No new poles will be installed.</p>	<p>The existing pole-mounted signal cabinet in the southeast quadrant will be removed and replaced with a new pole-mounted cabinet (24" w x 20" d x 46" h) in the same location. The new cabinet will be the same size as the existing cabinet. This cabinet upgrade will be inside the district.</p>
<p>WA7766 East Fuquay Springs Historic District (Study List) 2016 East Academy Street and Fuquay Avenue (Map B)</p>	<p>The new overhead fiber, lashed to new communications cable, will come from the south on existing utility poles along the west side of South Fuquay Avenue, across the street from the District. The fiber will be spliced overhead and will route to the existing utility pole located in the northwest quadrant and through a new riser to the pole-mounted signal cabinet. This work will be across the street from the District.</p>	<p>No new poles will be installed.</p>	<p>The existing pole-mounted signal cabinet in the northwest quadrant will be removed and replaced with a new pole-mounted cabinet (24" w x 20" d x 46" h) in the same location.</p>
<p>WA7766 East Fuquay Springs Historic District (Study List) 2016 East Academy Street and Main Street (Map B)</p>	<p>The new overhead fiber, lashed to existing communications cable, will come from the west on existing utility poles along the north side of East Academy Street, west of the District. The fiber will route through an existing riser to existing underground conduit. The fiber will then route to the existing junction box located in the northeast quadrant to the base-mounted signal cabinet. This work will be west of this District.</p>	<p>No new poles will be installed.</p>	<p>The existing base-mounted signal cabinet in the northeast quadrant will be removed and replaced with a new base-mounted cabinet (24" w x 20" d x 78" h) in the same location.</p>



East Fuquay Springs Historic District – Historic Resource/Study

<p>WA0485 Fuquay Springs High School (NR Listed) 112 N. Ennis Street (Map B)</p>	<p>The new overhead fiber, lashed to new messenger cable, will come from the west on existing utility poles along the north side of East Academy Street. The fiber will be spliced overhead and the new cable crosses East Academy Street just west of Ennis Street and then crosses Ennis Street just south of East Academy Street. The fiber will route down the utility pole at the signal cabinet, located in the southeast quadrant, and through a new riser to the pole-mounted signal cabinet. This work will be south of the historic resource.</p>	<p>No new poles will be installed.</p>	<p>The existing pole-mounted signal cabinet in the southeast quadrant will be removed and replaced with a new pole-mounted cabinet (24" w x 20" d x 46" h) in the same location.</p>
<p>WA4422 Fuquay Springs Teacherage (NR and Local Landmark) 602 East Academy Street (Map B)</p>	<p>The new overhead fiber, lashed to new messenger cable, will come from the west on existing utility poles along the north side of East Academy Street. The fiber will be spliced overhead and the new cable crosses East Academy Street just west of Ennis Street and then crosses Ennis Street just south of East Academy Street. The fiber will route down the utility pole at the signal cabinet, located in the southeast quadrant, through a new riser to the pole-mounted signal cabinet. This work will be adjacent to the historic resource.</p>	<p>No new poles will be installed.</p>	<p>The existing pole-mounted signal cabinet in the southeast quadrant will be removed and replaced with a new pole-mounted cabinet (24" w x 20" d x 46" h) in the same location.</p>

Corridor Construction Activities

Corridor	Cable Routing
<p>WA7766 East Fuquay Springs Historic District (Study List) 2016 Vance, Fuquay, Academy, Jones, and Main Streets (Map A/B/C)</p>	<p>New overhead fiber will enter from the west along the south side of West Vance Street, will be lashed to existing messenger cable, and will be attached to existing utility poles. An aerial splice enclosure will be installed on the south side of West Vance Street, and the new cables, lashed to existing messenger cable, will be routed west to the northeast quadrant of the intersection of South Main Street and West Vance Street by crossing West Vance Street and routing through an existing riser to existing underground conduit. The cable continues east to South Fuquay Avenue where it crosses South Fuquay Avenue. The existing span crossing South Fuquay Avenue will be removed and a new span crossing the street that consists of new fiber and messenger cable and an aerial guy will be installed on existing utility poles. The cable turns and crosses West Vance Street and then continues north on the east side of South Fuquay Avenue and then routes through a new riser to new underground conduit that crosses under South Fuquay Avenue. The cable then routes through a new riser to new overhead fiber that will be lashed to new messenger cable and attached to existing utility poles on the west side of South Fuquay Avenue. The existing fiber and messenger cable along the east side of South Fuquay Avenue will be removed. The new cable continues along the west side of South Fuquay Avenue. An aerial splice enclosure will be installed on the west side of South Fuquay Avenue, and the new cables will be routed to the north along the west side of South Fuquay Avenue lashed to new messenger cable, to the west along the north side of East Academy Street lashed to new messenger cable, and to the northeast quadrant of the intersection of South Main Street and East Academy Street. From this point, the eastbound fiber, lashed to new messenger cable, continues east along the north side of East Academy Street where it crosses North Aiken Street and North Woodrow Street. An aerial splice enclosure will be installed on the north</p>



East Fuquay Springs Historic District – Historic Resource/Study

side of East Academy Street, and the new cables will be routed to the southeast quadrant of the intersection of East Academy Street and Ennis Street. From the splice point on the west side of South Fuquay Avenue, the northbound fiber, lashed to new messenger cable, continues north on the west side of South Fuquay Avenue and crosses East Academy Street. The cable then continues north and is lashed to existing messenger cable where it crosses North Fuquay Avenue before East Jones Street and routes through a new riser to new underground conduit that routes to the north side of East Jones Street. The existing fiber and messenger cable that crosses East Jones Street and North Fuquay Avenue will be removed. The new fiber then routes through a new riser to new overhead fiber lashed to existing communications cable and continues west along the north side of East Jones Street. From this point, the fiber turns to the north at North Main Street and continues on the east side of North Main Street to a point beyond the historic area. Twelve down guys and one aerial guy will be installed on existing utility poles. This work will be inside and adjacent to the historic area within existing right of way/easements.

Legend

- ⊠ Upgraded Signal Cabinet
- Existing Overhead Cable
- Existing Underground Cable
- Proposed Overhead Cable
- Proposed Underground Cable
- ▭ Project Study Area
- ▭ Sheet Index Boundary
- ▭ Parks
- ▭ Greenways
- ▭ Open Space
- Designated Historic Resources**
- National Register individual listing
- NR and Local Landmark
- ★ NR Historic District center point
- ★ Study List individual entry
- ★ SL and Landmark
- ★ SL Historic District center point
- ★ SL and DOE
- ★ SL, DOE, and Landmark
- ★ SL and DOE Historic District center point
- ★ Determined Eligible - DOE
- ★ DOE and Landmark
- ★ DOE Historic District center point
- ★ Surveyed in NRHD
- ★ Surveyed, Landmark, in NRHD
- ★ Blockface in NRHD
- ★ Surveyed Area center point in NRHD
- ★ Local Historic District center point
- ▭ National Register District
- ▭ Study List
- ▭ Study List & Determined Eligible
- ▭ Determined Eligible

Source: North Carolina Historic Preservation Office.



**Fuquay-Varina Town-wide
Closed Loop Signal System**



TIP PROJECT NO. U-6022;
STATE PROJECT NO. 47148.1.1
Wake County, North Carolina

**HISTORIC RESOURCES AND PARKS
OVERVIEW MAP AND SHEET INDEX**

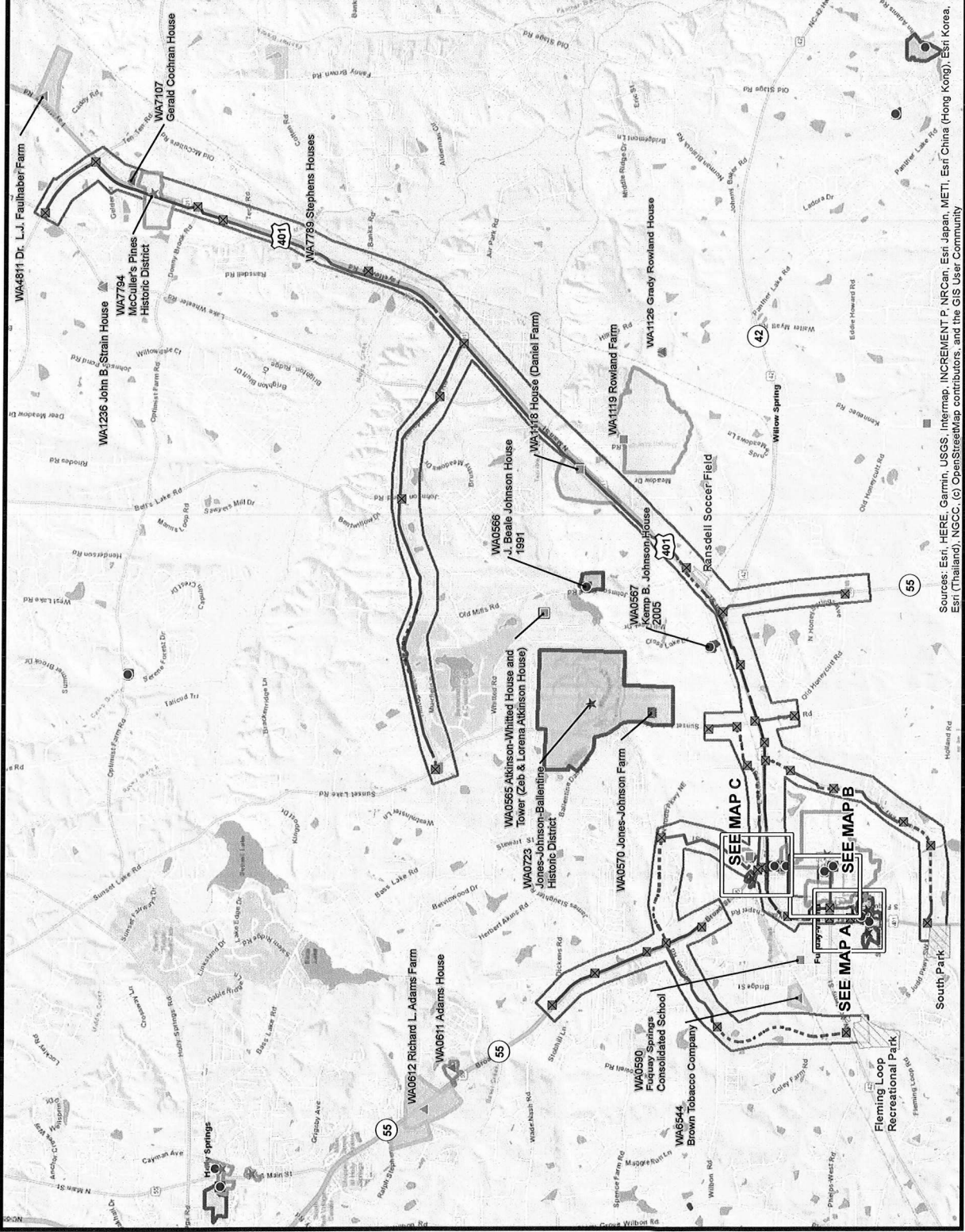

Sources: Esri, HERE, Garmin, USGS, Intermap, INCREMENT P, NRCan, Esri Japan, METI, Esri (China (Hong Kong)), Esri Korea, Esri (Tailand), INCC, (G) OpenStreetMap contributors, and the GIS User Community

FIGURE 1

**STATE OF NORTH CAROLINA
DEPARTMENT OF TRANSPORTATION
RALEIGH, NC**

BID BOND

Contract Number: DE00356 County: Wake County

KNOW ALL MEN BY THESE PRESENTS, That we, the PRINCIPAL CONTRACTOR (hereafter, PRINCIPAL) and SURETY above named, are held and firmly bound unto the Department of Transportation in the full and just sum of five (5) percent of the total amount bid by the Principal for the project stated above, for the payment of which sum well and truly to be made, we bind ourselves, our heirs, executors, administrators, and successors, jointly and severally, firmly by these presents.

NOW, THEREFORE, the condition of this obligation is: the Principal shall not withdraw its bid within sixty (60) days after the opening of the bids, or within such other time period as may be provided in the proposal, and if the Board of Transportation shall award a contract to the Principal, the Principal shall, within fourteen (14) calendar days after written notice of award is received by him, provide bonds with good and sufficient surety, as required for the faithful performance of the contract and for the protection of all persons supplying labor, material, and equipment for the prosecution of the work. In the event the Principal requests permission to withdraw his bid due to mistake in accordance with the provisions of Article 103-3 of the *Standard Specifications for Roads and Structures*, the conditions and obligations of this Bid Bond shall remain in full force and effect until the Department of Transportation makes a final determination to either allow the bid to be withdrawn or to proceed with award of the contract. In the event a determination is made to award the contract, the Principal shall have fourteen (14) calendar days to comply with the requirements set forth above. In the event the Principal withdraws its bid after bids are opened except as provided in Article 103-3, or after award of the contract has been made fails to execute such additional documents as may be required and to provide the required bonds within the time period specified above, then the amount of the bid bond shall be immediately paid to the Department of Transportation as liquidated damages.

IN TESTIMONY WHEREOF, the Principal and Surety have caused these presents to be duly signed and sealed.

This the _____ day of _____, 20 _____

Surety

By _____
General Agent or Attorney-in-Fact Signature

Seal of Surety

Print or type Signer's Name

BID BOND

CORPORATION

SIGNATURE OF CONTRACTOR (Principal)

Full name of Corporation

Address as prequalified

By

Signature of President, Vice President, Assistant Vice President
Select appropriate title

Print or type Signer's name

Affix Corporate Seal

Attest

Signature of Secretary, Assistant Secretary
Select appropriate title

Print or type Signer's name

BID BOND

LIMITED LIABILITY COMPANY

SIGNATURE OF CONTRACTOR (Principal)

Name of Contractor

Full name of Firm

Address as prequalified

**Signature of Member/
Manager/Authorized Agent**

Individually

Print or type Signer's name

BID BOND

INDIVIDUAL DOING BUSINESS UNDER A FIRM NAME

SIGNATURE OF CONTRACTOR (Principal)

Name of Contractor

Individual Name

Trading and doing business as

Full name of Firm

Address as prequalified

Signature of Contractor

Individually

Print or type Signer's name

Signature of Witness

Print or type Signer's name

BID BOND

INDIVIDUAL DOING BUSINESS IN HIS OWN NAME

SIGNATURE OF CONTRACTOR (Principal)

Name of Contractor

Print or type Individual Name

Address as prequalified

Signature of Contractor

Individually

Print or type Signer's name

Signature of Witness

Print or type Signer's name

BID BOND

PARTNERSHIP

SIGNATURE OF CONTRACTOR (Principal)

Full name of Partnership

Address as prequalified

By

Signature of Partner

Print or type Signer's name

Signature of Witness

Print or type Signer's name

BID BOND
JOINT VENTURE (2 or 3)
SIGNATURE OF CONTRACTORS (Principal)

Instructions to Bidders: **2 Joint Ventures**, Fill in lines (1), (2) and (3) and execute. **3 Joint Venturers** Fill in lines (1), (2), (3), (4) and execute. Line (1), print or type the name of Joint Venture. On line (2), print or type the name of one of the joint venturers and execute below in the appropriate manner required by Article 102-8 of the *Specifications*. On Line (3), print or type the name of second joint venturer and execute below in the appropriate manner required by said article of the Specifications. On Line (4), print or type the name of the third joint venturer, if applicable and execute below in the appropriate manner required by said article of the Specifications. This form of execution must be strictly followed.

_____ Signature of Witness or Attest	By	_____ Signature of Contractor
_____ Print or type Signer's name		_____ Print or type Signer's name

and

_____ Signature of Witness or Attest	By	_____ Signature of Contractor
_____ Print or type Signer's name		_____ Print or type Signer's name

and

_____ Signature of Witness or Attest	By	_____ Signature of Contractor
_____ Print or type Signer's name		_____ Print or type Signer's name

County: WAKE

Line #	Item Number	Sec #	Description	Quantity	Unit Cost	Amount
ROADWAY ITEMS						
0001	0000100000-N	800	MOBILIZATION	Lump Sum	L.S.	
0002	2591000000-E	848	4" CONCRETE SIDEWALK	5 SY		
0003	4447000000-E	SP	PEDESTRIAN CHANNELIZING DEVICES	200 LF		
0004	4457000000-N	SP	TEMPORARY TRAFFIC CONTROL	Lump Sum	L.S.	
0005	4510000000-N	1190	LAW ENFORCEMENT	1,000 HR		
0006	7048500000-E	1705	PEDESTRIAN SIGNAL HEAD (16", 1 SECTION W/COUNTDOWN)	8 EA		
0007	7060000000-E	1705	SIGNAL CABLE	11,730 LF		
0008	7120000000-E	1705	VEHICLE SIGNAL HEAD (12", 3 SECTION)	51 EA		
0009	7132000000-E	1705	VEHICLE SIGNAL HEAD (12", 4 SECTION)	8 EA		
0010	7144000000-E	1705	VEHICLE SIGNAL HEAD (12", 5 SECTION)	3 EA		
0011	7216000000-N	1705	MODIFY EXISTING VEHICLE SIGNAL HEAD	1 EA		
0012	7252000000-E	1710	MESSENGER CABLE (1/4")	71,085 LF		
0013	7264000000-E	1710	MESSENGER CABLE (3/8")	240 LF		
0014	7279000000-E	1715	TRACER WIRE	63,895 LF		
0015	7288000000-E	1715	PAVED TRENCHING (***** (1)(2"))	25 LF		
0016	7288000000-E	1715	PAVED TRENCHING (***** (2)(2"))	35 LF		
0017	7300000000-E	1715	UNPAVED TRENCHING (***** (1)(2"))	385 LF		

County: WAKE

Line #	Item Number	Sec #	Description	Quantity	Unit Cost	Amount
0018	7300000000-E	1715	UNPAVED TRENCHING (***** (2)(2"))	34,520 LF		
0019	7301000000-E	1715	DIRECTIONAL DRILL (***** (2)(2"))	18,580 LF		
0020	7312000000-N	1716	JUNCTION BOX (***** (SPECIAL-SIZED)	13 EA		
0021	7324000000-N	1716	JUNCTION BOX (STANDARD SIZE)	2 EA		
0022	7348000000-N	1716	JUNCTION BOX (OVER-SIZED, HEAVY DUTY)	176 EA		
0023	7360000000-N	1720	WOOD POLE	2 EA		
0024	7372000000-N	1721	GUY ASSEMBLY	186 EA		
0025	7396000000-E	1722	1/2" RISER WITH WEATHERHEAD	2 EA		
0026	7408000000-E	1722	1" RISER WITH WEATHERHEAD	4 EA		
0027	7420000000-E	1722	2" RISER WITH WEATHERHEAD	17 EA		
0028	7430000000-N	1722	HEAT SHRINK TUBING RETROFIT KIT	17 EA		
0029	7432000000-E	1722	2" RISER WITH HEAT SHRINK TUBING	80 EA		
0030	7444000000-E	1725	INDUCTIVE LOOP SAWCUT	1,440 LF		
0031	7456000000-E	1726	LEAD-IN CABLE (***** (14-2)	9,750 LF		
0032	7516000000-E	1730	COMMUNICATIONS CABLE (** FIBER) (24)	131,725 LF		
0033	7516000000-E	1730	COMMUNICATIONS CABLE (** FIBER) (48)	30,100 LF		
0034	7516000000-E	1730	COMMUNICATIONS CABLE (** FIBER) (72)	745 LF		

County: WAKE

Line #	Item Number	Sec #	Description	Quantity	Unit Cost	Amount
0035	7528000000-E	1730	DROP CABLE	13,605 LF		
0036	7540000000-N	1731	SPLICE ENCLOSURE	43 EA		
0037	7541000000-N	1731	MODIFY SPLICE ENCLOSURE	6 EA		
0038	7552000000-N	1731	INTERCONNECT CENTER	39 EA		
0039	7566000000-N	1733	DELINEATOR MARKER	143 EA		
0040	7575142200-N	SP	NEW ELECTRICAL SERVICE	1 EA		
0041	7575160000-E	1734	REMOVE EXISTING COMMUNICATIONS CABLE	8,295 LF		
0042	7636000000-N	1745	SIGN FOR SIGNALS	23 EA		
0043	7642100000-N	1743	TYPE I POST WITH FOUNDATION	3 EA		
0044	7642200000-N	1743	TYPE II PEDESTAL WITH FOUNDATION	6 EA		
0045	7684000000-N	1750	SIGNAL CABINET FOUNDATION	1 EA		
0046	7696000000-N	1751	CONTROLLERS WITH CABINET (***** (2070LX, BASE MTD)	26 EA		
0047	7696000000-N	1751	CONTROLLERS WITH CABINET (***** (2070LX, POLE MTD)	2 EA		
0048	7708000000-N	1751	DETECTOR CARD (***** (170)	177 EA		
0049	7980000000-N	SP	GENERIC SIGNAL ITEM 5/8" X 10' GROUNDING ELECTRODE	4 EA		
0050	7980000000-N	SP	GENERIC SIGNAL ITEM CCTV WOOD POLE	3 EA		
0051	7980000000-N	SP	GENERIC SIGNAL ITEM CONTROLLER (2070LX)	18 EA		

County: WAKE

Line #	Item Number	Sec #	Description	Quantity	Unit Cost	Amount
0052	7980000000-N	SP	GENERIC SIGNAL ITEM DIGITAL CCTV CAMERA ASSEMBLY	3 EA		
0053	7980000000-N	SP	GENERIC SIGNAL ITEM ETHERNET EDGE SWITCH	44 EA		
0054	7980000000-N	SP	GENERIC SIGNAL ITEM FIBER-OPTIC HUB CABINET (BASE MTD)	1 EA		
0055	7980000000-N	SP	GENERIC SIGNAL ITEM JUNCTION BOX MARKER	53 EA		
0056	7980000000-N	SP	GENERIC SIGNAL ITEM REMOVE WIRELESS COMMUNICATIONS EQUIPMENT	6 EA		
0057	7990000000-E	SP	GENERIC SIGNAL ITEM ETHERNET CABLE	425 LF		
0058	7990000000-E	SP	GENERIC SIGNAL ITEM HANDLASH & AERIAL CABLE PROTECTOR	445 LF		
0059	7990000000-E	SP	GENERIC SIGNAL ITEM SERVICE CONDUCTORS	130 LF		

1340/Jun06/Q399534/D422639202200/E59

Total Amount Of Bid For Entire Project :